



## About the **CHAUVIN ARNOUX GROUP**

Founded in 1893 in Paris, France, **CHAUVIN ARNOUX** has succeeded across the centuries in developing its expertise in the design, manufacture and marketing of measuring instruments for professionals.

From handheld instrumentation to fixed electrical equipment and energy performance systems, and from control of the whole thermal process chain through to industrial metrology, the **CHAUVIN ARNOUX GROUP's** offering covers every customer requirement, whatever the sector (self-employed electricians, industry, government, etc.)..

*"CHAUVIN ARNOUX is a major player  
on the measurement market  
in France and worldwide."*

### ***A few figures***

- ***10 subsidiaries worldwide***
- ***900 employees***
- ***7 production sites***
- ***6 R&D departments worldwide***
- ***11 % of revenues invested in R&D***
- ***Turnover of 100 million euros***

### *Your partner for:*

- *energy performance*
- *regulatory testing*
- *environmental measurements*
- *supervision and sizing of installations.*



## 4 expert measurement companies in one Group



Portable test and measurement instrumentation



Metering, measurement and energy performance



Temperatures in industrial processes



Metrology and regulatory testing

**CHAUVIN ARNOUX** draws on its two brands, Chauvin Arnoux® and Metrix® to propose a wide range of measuring instruments. The offering covers electrical measurement (testers, multimeters and current clamps), electrical safety testing, wattmeters and electrical network quality analysers. Their other areas of expertise include oscilloscopes, instruments for testing electronic devices and the measurement of physical parameters.

**ENERDIS** designs measuring equipment for electrical switchboards and develops smart systems for electricity metering and energy flow management in order to control consumption.

**PYROCONTROLE** offers measurement solutions to meet the test and control requirements of all process industries. A wide range of sensors and comprehensive expertise covering the whole industrial process make Pyrocontrole a crucial partner for the nuclear industry, the petrochemicals sector, the glass industry, metallurgy, etc.

**MANUMASURE** is the Chauvin Arnoux Group's specialist company for metrology and regulatory testing. It provides metrological testing, maintenance and management of measuring and testing instruments in laboratories or on customer sites. The company also offers regulatory testing in sectors such as the environment sector (pollutant emissions, noise, etc.), personal safety (electrical inspections, etc.) and hazard prevention (thermography, etc.). Its service offering is structured around three major market segments: Industry, the Environment and Health.

# the Current Clamps catalogue

S  
T  
R  
U  
C  
T  
U  
R  
E  
C  
O  
O  
R  
D  
I  
N  
A  
T  
E  
D  
F  
O  
R  
I  
N  
F  
O  
R  
M  
A  
T  
I  
O  
N

## Clamps and flexible probes “accessories”

Theoretical overview ..... i.1

### Selection guides

AC ..... i.2  
AC/DC ..... i.3  
Leakage / Scope / Process / CT output ..... i.4

### AC current clamps and flexible probes

- MINI series ..... 1.0
- MN series ..... 2.0
- Y series ..... 3.0
- C series ..... 4.0
- D series ..... 5.0
- B series ..... 6.0
- Mini**FLEX** series ..... 7.0
- Amp**FLEX**<sup>™</sup> series ..... 8.0

### AC/DC current clamps

- K series ..... 9.0
- E series ..... 10.0
- PAC series ..... 11.0

**Accessories** ..... 12.0

See last page for details of "made to order" model.

## A modern method for measuring electrical currents

### INTRODUCTION

Clamp are designed to extend the current measuring capabilities of DMMs, power instruments, oscilloscopes, hand-held scopes, recorders or loggers, and other diverse instruments.

The clamp is placed around the current-carrying conductor to perform non-contact current measurements without interrupting the circuit under test. The clamp outputs current or voltage signals directly proportional to the measured current, thereby providing current measuring and displaying capabilities to instruments with low current or voltage inputs.

When making a measurement, the current-carrying conductor circuit is not broken and remains electrically isolated from the instrument's input terminals. As a result, the instrument's low input terminal may be either floated or earthed. It is not necessary to interrupt the power supply when using a current clamp for taking measurements, so costly downtime can be eliminated.

True RMS measurements within the clamp's frequency response are possible by using most Chauvin Arnoux current clamps with a true RMS multimeter.

In most cases, RMS measurements are not limited by the clamps, but by the instrument to which they are connected. Best results are provided by clamps offering inherent high accuracy, good frequency response, and minimal phase shift.

Several Chauvin Arnoux clamps are patented for their unique circuitry and design.

## AC CURRENT CLAMPS

### THEORY OF OPERATION:

An AC current clamp may be viewed as a variant of a simple current transformer.

A transformer (figure 1) is essentially two coils wound on a common iron core. A current  $I_1$  is applied through the coil C1, inducing through the common core a current  $I_2$  in the coil C2. The number of turns of each coil and the current are related by:

$$N_1 \times I_1 = N_2 \times I_2$$

where  $N_1$  and  $N_2$  are the number of turns in each coil.

From this relationship:

$$I_2 = N_1 \times I_1 / N_2 \text{ ou } I_1 = N_2 \times I_2 / N_1.$$

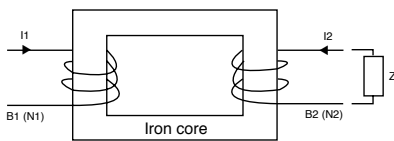

Figure 1

This same principle is applied to a current clamp (figure 2). The articulated magnetic core holds the coil B2 and clamps onto a conductor where the current  $I_1$  is flowing.

B1 is simply the conductor where the user is measuring the current with the number of turns  $N_1$  equal to one. The current sensor clamped around the conductor provides an output proportional to the number of turns in its coil B2, such that:

$I_2$  (clamp output) =  $N_1/N_2 \times I_1$  where  $N_1 = 1$  or clamp output =  $I_1/N_2$  (number of turns in the clamp's coil).

It is often difficult to measure  $I_1$  directly because of currents which are too high to be fed directly into a meter or simply because breaking into the circuit is not possible. To provide a manageable output level, a known number of turns is made on the clamp's coil.

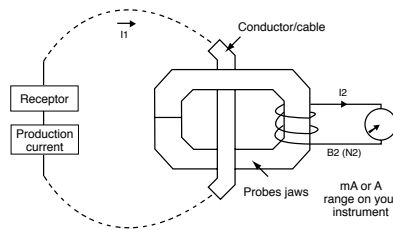

Figure 2

If  $N_2$  equals 1000, then the clamp has a ratio of  $N_1/N_2$  or  $1/1000$ , which is expressed as 1000:1. Another way to express this ratio is to say that the clamp output is 1 mA/A - the clamp output is 1 mA ( $I_2$ ) for 1 A (or 1 A @ 1000 A) flowing in the jaw window. There are numerous other ratios possible : 500:5, 2000:2, 3000:1, 3000:5, etc. for different applications.

The most common application is the use of a current clamp with a digital multimeter. Take as an example a current clamp with a ratio of 1000:1 (model C100) with an output of 1 mA/A. This ratio means that any current flowing through the probe jaws will result in a current flowing at the output:

Conductor input	Clamp output
1000 A	1 A
750 A	750 mA
250 A	250 mA
10 A	10 mA

The clamp output is connected to a DMM set on the AC current range to handle the clamp output. Then, to determine the current in the conductor, multiply the reading of the DMM by the ratio (e.g., 150 mA read on the 200 mA DMM range represents  $150 \text{ mA} \times 1000 = 150 \text{ A}$  in the conductor measured).

Current clamps may be used with other instruments with current ranges, provided that these instruments have the required input impedance (see figure 3).

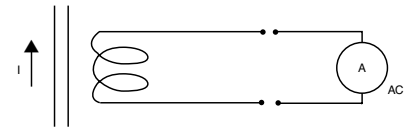

Figure 3

Current clamps may also have AC or DC voltage outputs to accommodate current measurements with instruments (loggers, scopes, etc.) with voltage ranges only (figures 4 and 5).

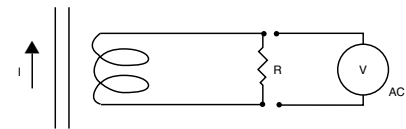

Figure 4

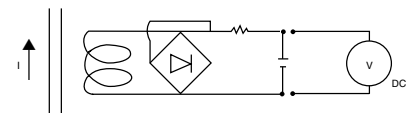

Figure 5

This is simply done by conditioning the current clamp output inside the clamp to provide voltage (e.g., model Y4N or MINI09). In these cases, the probe mV output is proportional to the measured current.

## OPERATING PRINCIPLE

The Amp**FLEX**<sup>™</sup> and Mini**FLEX** sensors are based on the principle of the Rogowski coil.

The primary circuit is constituted by the conductor carrying the alternating current to be measured, while the secondary is formed by a special coil wound on a flexible support.

At its terminals, this coil develops a voltage proportional to the derivative of the primary current to be measured:

$$u = \frac{\mu_0 \cdot n}{2\pi \cdot r} \times S \cdot \frac{di}{dt}$$

where  $\mu_0$  = vacuum permeability  
 $S$  = surface area of a turn  
 $n$  = number of turns  
 $r$  = core radius

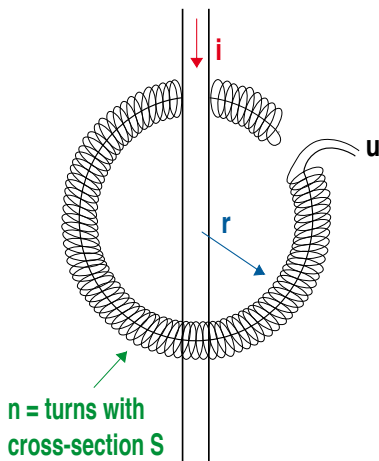

Rogowski coil

This AC voltage  $u$  is then passed via a screened cable to the casing containing all the processing electronics and the battery power supply.

Because there are not magnetic circuits on these sensors, they are very lightweight and flexible. Without magnetic circuits, there is no saturation effect or overheating.

This feature offers excellent linearity and low phase shift.

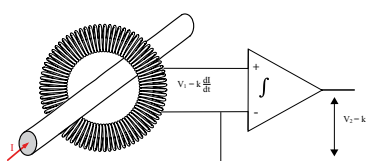

## AC/DC CLAMP-ON CURRENT PROBES

### THEORY OF OPERATION (HALL EFFECT)

Unlike on traditional AC transformers, AC/DC current measurement is often achieved by measuring the strength of a magnetic field created by a current-carrying conductor in a semiconductor chip using the Hall-effect principle.

When a thin semiconductor (figure 6) is placed at right angles to a magnetic field ( $B$ ), and a current ( $I_d$ ) is applied to it, a voltage ( $V_h$ ) is developed across the semiconductor. This voltage is known as the Hall voltage, named after the US scientist Edwin Hall who first reported the phenomenon.

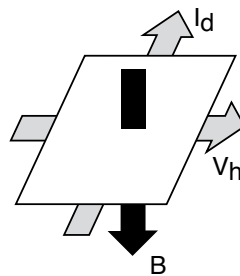

Figure 6

When the Hall device drive current ( $I_d$ ) is held constant, the magnetic field ( $B$ ) is directly proportional to the current in a conductor. Thus, the Hall output voltage ( $V_h$ ) is representative of that current.

Such an arrangement has two important benefits for universal current measurement.

First, since the Hall voltage is not dependent on a reversing magnetic field, but only on its strength, the device can be used for DC measurement.

Second, when the magnetic field strength varies due to varying current flow in the conductor, response to change is instantaneous. Thus, complex AC wave forms may be detected and measured with high accuracy and low phase shift

The basic construction of a clamp jaw assembly is shown in figure 7, (note: one or two Hall generators are used depending on the type of current clamp).

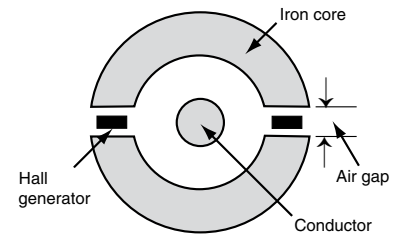

Figure 7

The Chauvin Arnoux AC/DC current clamps were developed using the above principle, together with patented electronic circuitry incorporating signal conditioning for linear output and a temperature compensation network. These have a wide dynamic range and frequency response with highly accurate linear output, for application in all areas of current measurement up to 1,500 A. Direct currents can be measured without the need of expensive, power-consuming shunts, and alternating currents up to several kHz can be measured accurately to respond to the requirements of complex signals and RMS measurements. The clamp outputs are in mV (mV DC when measuring DC, and mV AC when measuring AC) and may be connected to most instruments with a voltage input, such as DMMs, loggers, oscilloscopes, handheld scopes, recorders, etc.

Chauvin Arnoux also offers various technologies for DC measurements, as in the K1 and K2, designed to measure very low DC currents and using saturated magnetic circuit technology.

The AC/DC clamps also offer the opportunity to display or measure True RMS in AC or AC+DC.

## AC OR DC CURRENT MEASUREMENT

- Connect the clamp to the instrument
- Select the function and range
- Clamp the clamp around a single conductor
- Read the conductor's current value

Examples (figure 8):

### AC: clamp model: Y2N

Ratio : 1000:1  
 Output: 1 mA AC/A AC  
 DMM: set to 200 mA AC range  
 DMM reading: 125 mA AC  
 Current in conductor :  
 $125 \text{ mA} \times 1000 = 125 \text{ A AC}$

### DC : clamp model: PAC 21

1 mV DC/A DC (Hall sensor)  
 DMM: set to 200 mV DC range  
 DMM reading: 160 mV DC  
 Current in conductor: 160 A DC

### AC : clamp model: PAC 11

Output : 1 mV AC/A AC  
 (Hall sensor)  
 DMM: set to 200 mV AC range  
 DMM reading: 120 mV AC  
 Current in conductor: 120 A AC

### DC : micro clamp K1

Output: 1 mV/mA  
 DMM: set to 200 mV DC range  
 DMM reading: 7.4 mV DC  
 Current in conductor: 7.4 mA

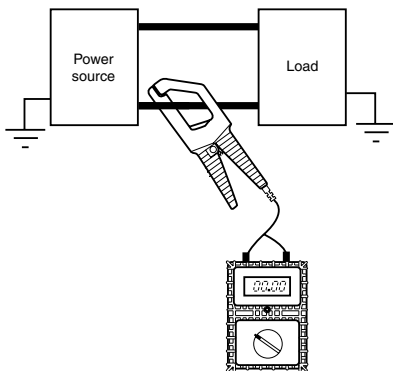

Figure 8

## MEASUREMENTS OF LOW CURRENTS, PROCESS LOOPS AND LEAKAGE CURRENTS

Numerous clamps are offered for low current measurements. For example, models K1 and K2 have a 50 mA DC sensitivity and the model K2 may be used on 4-20 mA process loops.

### Example: 4-20 mA loop

Clamp model: K2  
 Output: 10 mV/mA  
 DMM: set to 200 mV DC range  
 DMM reading: 135 mV DC  
 Loop current: 13.5 mA DC

When the current to be measured is too low for the clamp or better accuracy is required, it is possible to insert the conductor multiple times through the probe jaws. The value of the current is the ratio of the reading to the number of turns.

### Example: figure 9

#### Clamp model: C100

Ratio: 1000:1  
 DMM: set to 200 mA AC range  
 Turns in clamp jaw: 10  
 DMM reading: 60 mA AC  
 Current in conductor:  
 $60 \text{ mA} \times 1,000 / 10 = 6,000 \text{ mA} = 6 \text{ A}$

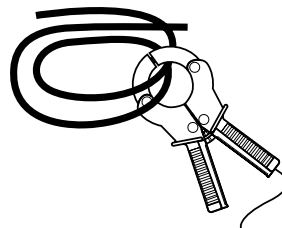

Figure 9

When the clamp is placed around two conductors with different polarities, the resulting reading will be the difference between the two currents. If the currents are the same, the reading will be zero (figure 10).

When a reading other than zero is obtained, the reading is the amount of leakage current on the load.

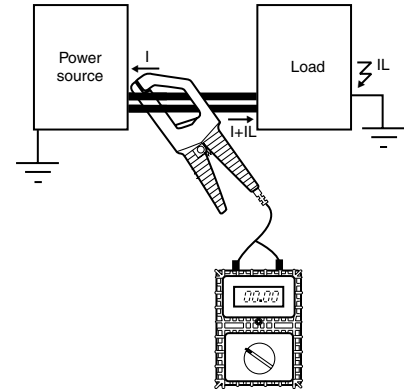

Figure 10

To measure low currents or leakage, you need a clamp which will measure low values, such as the model B102 or C173.

However, earth leakage currents may also be measured directly with the simple model (figure 11).

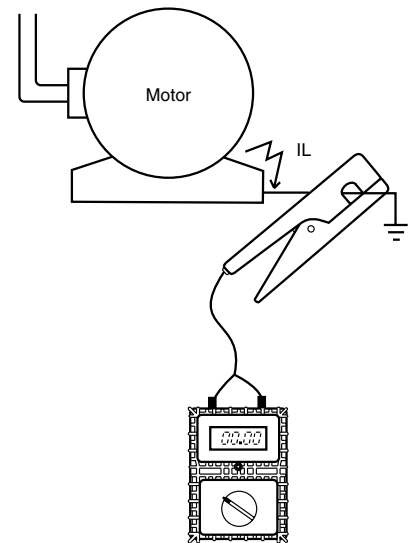

Figure 11

### Example: figure 11

#### MINI 05

Ratio: 1 mV AC/mA AC  
 DMM: set to 200 mA AC range  
 DMM reading: 10 mV AC  
 Leakage current: 10 mA AC



## SELECTING A CURRENT PROBE

Answering the following questions will help you to select the appropriate clamp for your applications:

- 1- Determine if you are measuring AC or DC (DC current clamps are categorized as AC/DC because they measure both).
- 2- What is the the maximum current you will measure, and what is the minimum current you will measure? Check that the accuracy at low levels is appropriate, or select a low-current measurement clamp.

Most clamps perform with greater accuracy at the upper end of their range. Several clamps are designed to measure very low DC or AC.

3- What size conductor will you clamp onto? This parameter determines the clamp jaw size needed.

4- What type of clamp output do you need or can you work with (mA, mV, AC, DC, etc.)? Check the maximum receiver impedance to ensure that the clamp will perform to specifications.

Other factors you may want to consider:

■ What is the working voltage of the conductor to be measured ?

Chauvin Arnoux clamps must not be used above 600 volts (see specifications).



■ What type of termination do you need: sockets, banana leads or BNC leads ?

■ Will the probe be used for harmonics or power clamp ?

Look at the frequency specifications and phase shift specifications.



## Measurement of AC current

Selection guide

Series	Model	Input						Output - Connections			Specific features					To order		
		Measuring range <sup>(1)</sup>						Current	Voltage	Lead + Ø 4 mm safety connectors <sup>(3)</sup>	Ø 4 mm female sockets	BNC connector (coaxial)	Transformation ratio (input/output)	Output protected against voltage surges	Automatic DC voltage		Measurement of power (slight phase shift)	Bandwidth (frequency in Hz)
Very weak current	Weak current	Medium current	Strong current	AC	DC													
 Chap. 1	MINI 01	2...150 A			●		0.15 A AC		●			1000/1	●			48 Hz... 500 Hz	≤ 2.5%	P01105101Z
	MINI 02	50 mA...100 A			●		0.15 A AC		●			1000/1	●	●	48 Hz... 10 kHz	≤ 1%	P01105102Z	
	MINI 03	1...100 A			●			0.1 V AC	●			1 A / 1 mV					≤ 2%	P01105103Z
	MINI 05	5 mA...10 A 1...100 A			●			10 V AC 0.1 V AC	●			1 mA / 1 mV 1 A / 1 mV			48 Hz... 500 Hz	≤ 3%	P01105105Z	
	MINI 09	1...150 A			●			15 V DC	●			1 A / 100 mV					≤ 4%	P01105109Z
 Chap. 2	MN 08	0.5...240 A			●		0.2 A AC		●			1000/1			40 Hz...10 kHz	≤ 1%	P01120401	
	MN 09	0.5...240 A			●		0.2 A AC		●			1000/1				≤ 1%	P01120402	
	MN 10	0.5...240 A			●		0.2 A AC		●			1000/1	●			≤ 2%	P01120403	
	MN 11	0.5...240 A			●		0.2 A AC		●			1000/1	●			≤ 2%	P01120404	
	MN 12	0.5...240 A			●			2 V AC	●			1 A / 10 mV				≤ 1%	P01120405	
	MN 13	0.5 A...240 A			●			2 V AC	●			1 A / 10 mV				≤ 1%	P01120406	
	MN 14	0.5 A...240 A			●			0.2 V AC	●			1 A / 1 mV				≤ 1%	P01120416	
	MN 15	0.5 A...240 A			●			0.2 V AC	●			1 A / 1 mV				≤ 1%	P01120417	
	MN 21	0.1 A...240 A			●		0.2 A AC		●			1000/1	●			≤ 2%	P01120418	
	MN 23	0.1 A...240 A			●			2 V AC	●			1 A / 10 mV				≤ 1.5%	P01120419	
	MN 38	0.1 A...24 A 0.5 A...240 A			●			2 V AC 2 V AC		●		1 A / 100 mV 1 A / 10 mV				≤ 1%	P01120407	
	MN 39	0.1 A...24 A 0.5 A...240 A			●			2 V AC 2 V AC	●			1 A / 100 mV 1 A / 10 mV				≤ 1%	P01120408	
	MN 60	0.1 A...60 Apeak 0.5 A...600 Apeak			●			6 Vpeak 6 Vpeak		●		1 A / 100 mV 1 A / 10 mV				40 Hz...40 kHz	≤ 2% ≤ 1.5%	P01120409
	MN 71	10 mA...12 A			●			1 V AC	●			1 A / 100 mV				≤ 1%	P01120420	
	MN 73	10 mA...2.4 A 100 mA...240 A			●			2 V AC 2 V AC	●			1 mA / 1 mV 1 A / 10 mV				40 Hz...10 kHz	≤ 1% ≤ 2%	P01120421
MN 88	0.5 A...240 A			●			20 V DC <sup>(2)</sup>	●	●		1 A / 100 mV			≤ 2%	P01120410			
MN 89	0.5 A...240 A			●			20 V DC <sup>(2)</sup>	●			1 A / 100 mV			≤ 2%	P01120415			
 Chap. 3	Y1N	4 A...600 A			●		0.5 A AC		●			1000/1	●		48 Hz...1 kHz	≤ 3%	P01120001A	
	Y2N	4 A...600 A			●		0.5 A AC		●			1000/1	●			≤ 1%	P01120028A	
	Y3N	4 A...600 A			●		5 A AC		●			100/1				≤ 3%	P01120029A	
	Y4N	4 A...600 A			●			0.5 V DC <sup>(2)</sup>	●			500 A / 0.5 V				≤ 1%	P01120005A	
	Y7N	1 A...1200 Apeak			●			1.2 Vpeak	●			1 A / 1 mV				5 Hz...10 kHz	≤ 2%	P01120075

(1) The upper value corresponds to 120 % of the maximum rated value (2) Reformating of AC signal by diodes

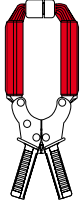
(3) Lead + electronic unit with Ø 4 mm safety connectors, centre distance 19 mm, for K and AmpFLEX™ series

Series	Model	Input						Output - Connections				Specific features						To order	
		Measuring range <sup>(1)</sup>						Current	Voltage	Lead + Ø 4 mm safety connectors <sup>(3)</sup>	Ø 4 mm female sockets	BNC connector (coaxial)	Transformation ratio (input/output)	Output protected against voltage surges	Automatic DC voltage	Measurement of power (slight phase shift)	Bandwidth (frequency in Hz)		Typical accuracy
		Very weak current	Weak current	Medium current	Strong current	AC	DC												
 Chap. 4	C100	0.1 A...1200 A				●	1 A AC		●			1000/1				30 Hz...10 kHz	≤ 0.5%	P01120301	
	C102	0.1 A...1200 A				●	1 A AC		●			1000/1	●				≤ 0.5%	P01120302	
	C103	0.1 A...1200 A				●	1 A AC		●			1000/1	●				≤ 0.5%	P01120303	
	C106	0.1 A...1200 A				●		1 V AC		●		1 A / 1 mV					≤ 0.5%	P01120304	
	C107	0.1 A...1200 A				●		1 V AC		●		1 A / 1 mV					≤ 0.5%	P01120305	
	C112	1 mA...1200 A				●	1 A AC		●			1000/1	●	●			≤ 0.3%	P01120314	
	C113	1 mA...1200 A				●	1 A AC		●			1000/1	●	●			≤ 0.3%	P01120315	
	C116	1 mA...1200 A				●		1 V AC		●		1 A / 1 mV			●		≤ 0.3%	P01120316	
	C117	1 mA...1200 A				●		1 V AC		●		1 A / 1 mV			●		≤ 0.3%	P01120317	
	C122	1 A...1200 A				●	5 A AC		●			1000/5	●				≤ 1%	P01120306	
	C148	1 A...300 A				●	5 A AC		●			250/5	●				48 Hz...1 kHz	≤ 2%	P01120307
		1 A...600 A								500/5		≤ 1%							
		1 A...1200 A								1000/5		≤ 1%							
C160	0.1 A...30 Apeak				●		3 Vpeak	●			10 A / 1 V				10 Hz ...100 kHz	≤ 3%	P01120308		
	0.1 A...300 Apeak								3 Vpeak		100 A / 1 V		≤ 2%						
	1 A...2000 Apeak								2 Vpeak		1000 A / 1 V		≤ 1%						
C173	1 mA...1.2A				●		1 V AC	●			1 A / 1 V				10 Hz...3 kHz	≤ 0.7%	P01120309		
	0,01 A...12 A									10 A / 1 V	≤ 0.5%								
	0.1 A...120 A									100 A / 1 V	≤ 0.3%								
	1 A...1200 A									1000 A / 1 V	≤ 0.2%								
 Chap. 5	D30N	1 A...3600 A				●	1 A AC		●		3000/1	●	●	30 Hz...5 kHz	≤ 0.5%	P01120049A			
	D30CN	1 A...3600 A				●	1 A AC		●		3000/1	●	●		≤ 0.5%	P01120064			
	D31N	1 A...600 A				●	1 A AC		●			500/1	●			30 Hz...1.5 kHz	≤ 3%	P01120050A	
		1 A...1200 A								1000/1		≤ 1%							
		1 A...1800 A								1500/1		≤ 0.5%							
	D32N	1 A...1200 A				●	1 A AC		●			1000/1	●		●	30 Hz...1 kHz	≤ 1%	P01120051A	
		1 A...2400 A								2000/1		≤ 0.5%							
		1 A...3600 A								3000/1		≤ 0.5%							
	D33N	1 A...3600 A				●	5 A AC		●			3000/5				30 Hz...5 kHz	≤ 1%	P01120052A	
	D34N	1 A...600 A				●	5 A AC		●			500/5				30 Hz...1.5 kHz	≤ 3%	P01120053A	
		1 A...1200 A								1000/5		≤ 1%							
		1 A...1800 A								1500/5		≤ 0.5%							
	D35N	1 A...1200 A				●	5 A AC		●			1000/5	●			30 Hz...1.5 kHz	≤ 1%	P01120054A	
1 A...2400 A					2000/5					≤ 0.5%									
1 A...3600 A					3000/5					≤ 0.5%									
D36N	1 A...3600 A				●	3 A AC		●			3000/3	●	●	30 Hz...5 kHz	≤ 0.5%	P01120055A			
D37N	0.1 A...36 A				●		3 V AC	●			30 A/3 V			30 Hz...5 kHz	≤ 2%	P01120056A			
	1 A...360 A									300 A/3 V									
	1 A...3600 A									3000 A/3 V									
D38N	1 A...90 Apeak				●		0.9 Vpeak	●			1 A / 10 mV			30 Hz...50 kHz	≤ 2%	P01120057A			
	1 A...900 Apeak									1 A / 1 mV									
	1 A...9000 Apeak									1 A / 0.1 mV									
 Chap. 6	B102	500 µA...4 A				●		4 V AC	●		1 mA / 1 mV			10 Hz...1 kHz	≤ 0.5%	P01120083			
		0.5 A...400 A						0.4 V AC			1 A / 1 mV				≤ 0.35%				

(1) The upper value corresponds to 120 % of the maximum rated value  
 (3) Lead + electronic unit with Ø 4 mm safety connectors, centre distance 19 mm, for K and AmpFLEX™ series

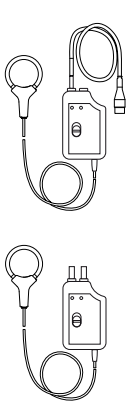
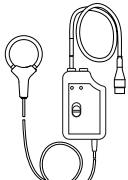
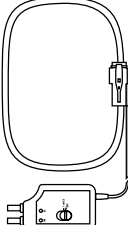
Series	Model	Input						Output - Connections			Specific features						To order		
		Measuring range <sup>(1)</sup>						Current	Voltage	Lead + Ø 4 mm safety connectors <sup>(3)</sup>	Ø 4 mm female sockets	BNC connector (coaxial)	Transformation ratio (input/output)	Output protected against voltage surges	Automatic DC voltage	Measurement of power (slight phase shift)		Bandwidth (frequency in Hz)	Typical accuracy
Very weak current	Weak current	Medium current	Strong current	AC	DC														
 <p>Chap. 7</p>	MA100 30-300/3 (17 cm)	0.5 A...30 A	0.5 A...300 A					3 V AC	●			100 mV/A 10 mV/A					5 Hz...20 kHz	≤ 1%	P01120560
	MA100 30-300 /3 (17 cm)	0.5 A...30 A	0.5 A...300 A					3 V AC		●		100 mV/A 10 mV/A						≤ 1%	P01120563
	MA100 300-3000/3 (25 cm)	0.5 A...300 A	0.5 A...3000 A					3 V AC	●			10 mV/A 1 mV/A						≤ 1%	P01120561
	MA100 300-3000/3 (25 cm)	0.5 A...300 A	0.5 A...3000 A					3 V AC			●	10 mV/A 1 mV/A						≤ 1%	P01120564
	MA100 300-3000 /3 (35 cm)	0.5 A...300 A	0.5 A...3000 A					3 V AC	●			10 mV/A 1 mV/A						≤ 1%	P01120562
	MA100 300-3000/3 (35 cm)	0.5 A...300 A	0.5 A...3000 A					3 V AC			●	10 mV/A 1 mV/A						≤ 1%	P01120565
 <p>Chap. 7</p>	MA200 30-300/3 (17 cm)	0.5 A...45 Apeak	0.5 A...450 Apeak					4.5 V peak			●	100 mV/A 10 mV/A					5 Hz...1 MHz	≤ 1% + 0.3 A	P01120570
	MA200 30-300/3 (25 cm)	0.5 A...45 Apeak	0.5 A...450 Apeak					4.5 V peak			●	100 mV/A 10 mV/A						≤ 1% + 0.3 A	P01120571
	MA200 3000/3 (35 cm)	5 A...4500 Apeak						4.5 V peak			●	1 mV/A						≤ 1% + 0.3 A	P01120572
 <p>Chap. 8</p>	A100 20-200/2 (45 cm)	0.5 A...20 A	0.5 A...200 A					2 V AC	●			1 A / 100 mV 1 A / 10 mV					10 Hz...20 kHz	≤ 1%	P01120503
	A100 2000/2 (45 cm)		0.5 A...2000 A					2 V AC	●			1 A / 1 mV						≤ 1%	P01120501
	A100 2000/2 (80 cm)		0.5 A...2000 A					2 V AC	●			1 A / 1 mV						≤ 1%	P01120502
	A100 0.2-2 k/2 (45 cm)	0.5 A...200 A	0.5 A...2000 A					2 V AC	●			1 A / 10 mV 1 A / 1 mV						≤ 1%	P01120504
	A100 0.2-2 k/2 (80 cm)	0.5 A...200 A	0.5 A...2000 A					2 V AC	●			1 A / 10 mV 1 A / 1 mV						≤ 1%	P01120505
	A100 0.3-3 k/3 (45 cm)	0.5 A...300 A	0.5 A...3000 A					3 V AC	●			1 A / 10 mV 1 A / 1 mV						≤ 1%	P01120506
	A100 0.3-3 k/3 (80 cm)	0.5 A...300 A	0.5 A...3000 A					3 V AC	●			1 A / 10 mV 1 A / 1 mV						≤ 1%	P01120507
	A100 0.3-3 k/3 (120 cm)	0.5 A...300 A	0.5 A...3000 A					3 V AC	●			1 A / 10 mV 1 A / 1 mV						≤ 1%	P01120508
	A100 1-10 k/1 (120 cm)	0.5 A...1000 A	0.5 A...10000 A					1 V AC	●			1 A / 1 mV 1 A / 0.1 mV						≤ 1%	P01120509



(1) The upper value corresponds to 120 % of the maximum rated value  
 (3) Lead + electronic unit with Ø 4 mm safety connectors, centre distance 19 mm, for K and AmpFLEX™ series

Series	Model	Input				Output - Connections				Specific features					To order			
		Measuring range <sup>(1)</sup>				Current	Voltage	Lead + Ø 4 mm safety connectors <sup>(3)</sup>	Ø 4 mm female sockets	BNC connector (coaxial)	Transformation ratio (input/output)	Output protected against voltage surges	Automatic DC voltage	Measurement of power (slight phase shift)		Bandwidth (frequency in Hz)	Typical accuracy	
Very weak current	Weak current	Medium current	Strong current	AC	DC													
Chap. 9	K1	1 mA...4.5 A DC	1 mA...3 A RMS	1 mA...4.5 Apeak	●	●	●			4.5 V AC 3 V RMS 4.5 V peak	●		1 mA / 1 mV			DC...2 kHz	≤ 1%	P01120067A
	K2	100 µA...450 mA DC	100 µA...300 mA RMS	100 µA...450 mApeak	●	●	●			4.5 V AC 3 V RMS 4.5 V peak	●		1 mA / 10 mV			DC...1.5 kHz	≤ 1%	P01120074A
Chap. 10	E1N	0,05 A...2 A DC	0,05 A...1.5 A AC	0.5 A...150 A AC/DC	●	●	●			2 V DC 1.5 V AC 150 mV AC/ DC	●		1 A / 1 V 1 A / 1 mV			DC... 2 kHz DC... 8 kHz	≤ 2% ≤ 1.5%	P01120030A
	E3N	0,05 A...10 Apeak	1 A...100 Apeak		●	●			1 V peak		●		1 A / 100 mV 1 A / 10 mV			DC...100 kHz	≤ 3% ≤ 4%	P01120043A
	E6N	5 mA...2 A DC	5 mA...1.5 A AC	20 mA...80 A AC/DC	●	●	●			2 V DC 1.5 V AC 0,8 V AC/ DC	●		1 A / 1 V 1 A / 10 mV			DC... 2 kHz DC... 8 kHz	≤ 2% ≤ 4%	P01120040A
Chap. 11	PAC10	0.5 A...400 A AC	0.5 A...600 A DC		●	●	●			600 mV AC/DC	●		1 A / 1 mV			DC...5 kHz	≤ 2%	P01120070
	PAC11	0.2 A...40 A AC	0.4 A...60 A DC	0.5 A...400 A AC	●	●	●			600 mV AC/DC	●		1 A / 10 mV 1 A / 1 mV	●		DC...10 kHz	≤ 1.5% ≤ 2%	P01120068
	PAC12	0.2 A...60 Apeak	0.4 A...60 A DC	0.5 A...600 Apeak	●	●	●			600 mVpeak		●	1 A / 10 mV 1 A / 1 mV	●		DC...10 kHz	≤ 1.5% ≤ 2%	P01120072
Chap. 11	PAC20	0.5 A...1000 A AC	0.5 A...1400 A DC		●	●	●			1.4 V AC/DC	●		1 A / 1 mV			DC...5 kHz	≤ 2%	P01120071
	PAC21	0.2 A...100 A AC	0.4 A...150 A DC	0.5 A...1000 A AC	●	●	●			1.5 V AC/DC	●		1 A / 10 mV 1 A / 1 mV	●		DC...10 kHz	≤ 1.5% ≤ 2.5%	P01120069
	PAC22	0.2 A...150 Apeak	0.4 A...150 A DC	0.5 A...1400 Apeak	●	●	●			1.4 V peak		●	1 A / 10 mV 1 A / 1 mV	●		DC...10 kHz	≤ 1.5% ≤ 2.5%	P01120073









(1) The upper value corresponds to 120 % of the maximum rated value  
 (3) Lead + electronic unit with Ø 4 mm safety connectors, centre distance 19 mm, for K and AmpFLEX™ series

Series	Model	Input						Output - Connections			Specific features						To order
		Measuring range <sup>(1)</sup>						Current	Voltage	Lead + Ø 4 mm safety connectors <sup>(3)</sup>	Ø 4 mm female sockets	BNC connector (coaxial)	Transformation ratio (input/output)	Output protected against voltage surges	Automatic DC voltage	Measurement of power (slight phase shift)	
Very weak current	Weak current	Medium current	Strong current	AC	DC												

### Leakage current measurement

 Chap. 2	<b>MN73</b>	10 mA...2.4 A 100 mA...240 A					2 V AC 2 V AC				1 A / 1000 mV 1 A / 10 mV				40 Hz...10 kHz	≤ 1% ≤ 2%	P01120421
 Chap. 4	<b>C173</b>	1 mA...1.2A 0,01 A...12 A 0.1 A...120 A 1 A...1200 A					1 V AC				1 A / 1 V 10 A / 1 V 100 A / 1 V 1000 A / 1 V				10 Hz...3 kHz	≤ 0.7% ≤ 0.3% ≤ 0.5% ≤ 0.2%	P01120309
 Chap. 6	<b>B102</b>	500 µA...4 A 0.5 A...400 A					4 V AC 0.4 V AC				1 mA / 1 mV 1 A / 1 mV				10 Hz...1 kHz	≤ 0.5% ≤ 0.35%	P01120083

### Measurement on oscilloscope

 Chap. 2	<b>MN60</b>	0.1 A...60 Apeak 0.5 A...600 Apeak					6 Vpeak 6 Vpeak				1 A / 100 mV 1 A / 10 mV				40 Hz...40 kHz	≤ 2% ≤ 1.5%	P01120409
 Chap. 3	<b>Y7N</b>	1 A...1200 Apeak					1.2 Vpeak				1 mA / 1 mV				5 Hz...10 kHz	≤ 2%	P01120075
 Chap. 4	<b>C160</b>	0.1 A...30 Apeak 1 A...300 Apeak 1 A...2000 Apeak					3 Vpeak 3 Vpeak 2 Vpeak				10 A / 1 V 100 A / 1 V 1000 A / 1 V				10 Hz...100 kHz	≤ 3% ≤ 2% ≤ 1%	P01120308
 Chap. 5	<b>D38N</b>	1 A...90 Apeak 1 A...900 Apeak 1 A...9000 Apeak					0.9 Vpeak				1 A / 10 mV 1 A / 1 mV 1 A / 0.1 mV				30 Hz...50 kHz	≤ 2%	P01120057A
 Chap. 10	<b>E3N</b>	0,05 A...10 Apeak 1 A...100 Apeak					1 Vpeak				1 A / 10 mV 1 A / 1 mV				DC...100 kHz	≤ 3% ≤ 4%	P01120043A
 Chap. 7	<b>MA200 30-300/3</b> (17 cm / Ø 4.5 cm)	0.5 A...45 Apeak 0.5 A...450 Apeak					4.5 Vpeak				100 mV/A 10 mV/A					≤ 1% + 0.3 A	P01120570
	<b>MA200 30-300/3</b> (25 cm / 7 cm)	0.5 A...45 Apeak 0.5 A...450 Apeak					4.5 Vpeak				100 mV/A 10 mV/A			5 Hz...1 MHz	≤ 1% + 0.3 A	P01120571	
	<b>MA200 3000/3</b> (35 cm / Ø 10 cm)	5 A...4500 Apeak					4.5 Vpeak				1 mV/A				≤ 1% + 0.3 A	P01120572	
 Chap. 11	<b>PAC12</b>	0.2 A...60 Apeak 0.4 A...60 A DC 0.5 A...600 Apeak 0.5 A...600 A DC					600 mVpeak				1 A / 10 mV 1 A / 1 mV				DC...10 kHz	≤ 1.5% ≤ 2%	P01120072
 Chap. 11	<b>PAC22</b>	0.2 A...150 Apeak 0.4 A...150 A DC 0.5 A...1400 Apeak 0.5 A...1400 A DC					1.5 Vpeak 1.4 Vpeak				1 A / 10 mV 1 A / 1 mV				DC...10 kHz	≤ 1.5% ≤ 2.5%	P01120073

### Measurement of process current

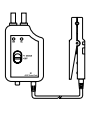
 Chap. 9	<b>K1</b>	1 mA...4.5 A DC 1 mA...3 A RMS 1 mA...4.5 Apeak					4.5 V DC 3 V RMS 4.5 Vpeak				1 mA / 1 mV				DC...2 kHz	≤ 1%	P01120067A
	<b>K2</b>	100 µA...450 mA DC 100 µA...300 mA RMS 100 µA...450 mApeak					4.5 V DC 3 V RMS 4.5 Vpeak				1 mA / 10 mV				DC...1.5 kHz	≤ 1%	P01120074A

### Measurement on secondary winding of current transformers

 Chap. 2	<b>MN71</b>	10 mA...12 A					1 V AC				1 A / 100 mV				40 Hz...10 kHz	≤ 1%	P01120420
--	-------------	--------------	--	--	--	--	--------	--	--	--	--------------	--	--	--	----------------	------	-----------

(1) The upper value corresponds to 120 % of the maximum rated value  
(3) Lead + electronic unit with Ø 4 mm safety connectors, centre distance 19 mm, for K and AmpFLEX™ series



## MINI series

Small, compact and particularly resistant, this range of miniature clamps is designed for measurements from a few milli-amperes to 150 A AC. Their shape makes them very practical in confined spaces, such as circuit-breaker boards, control panels or control boxes. They are ideal for use with multimeters.

There are two types of MINI clamps.

The first type operates like a traditional current transformer and provides a current output (mA) which can be used with multimeters, loggers or instruments with current calibres.

The second provides a voltage output proportional to the current measured.

This voltage output enables instruments with AC voltage calibres to display or store current values.

There is also a model with a DC voltage output.

The MINI clamps give True RMS results when used with a True RMS instrument.

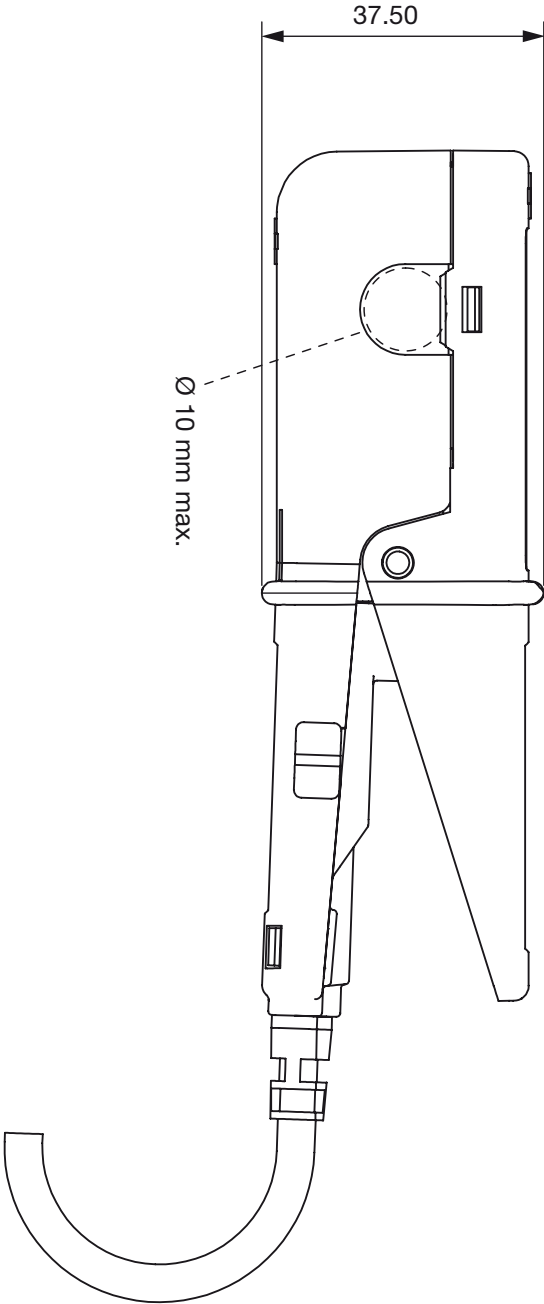
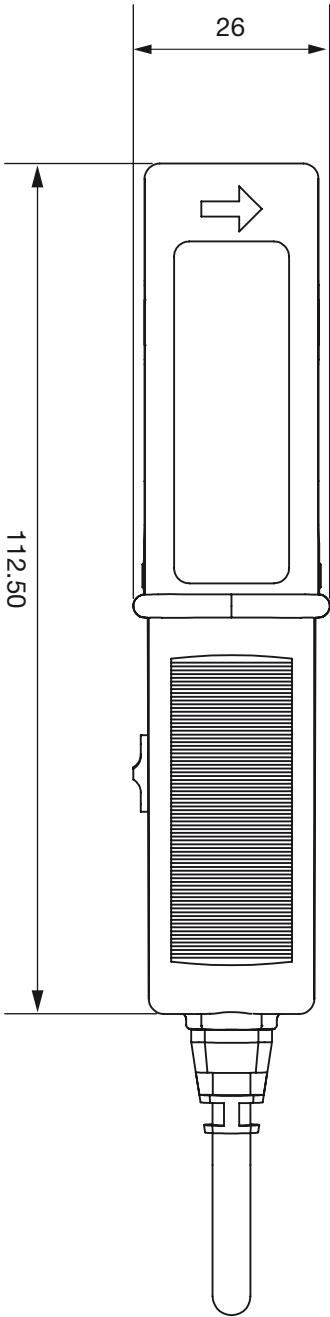

# Current clamp for AC current

## Model MINI 01

MINI series

Calibre	150 A AC
Sensitivity	1 mA/A (1000/1)



### Description

Small and compact, the MINI 01 current clamp is the ideal complement for any multimeter to measure AC currents in low-power tertiary or industrial applications. If there is a current in the conductor clamped, the MINI 01 clamp is protected against overvoltages during disconnection from the measurement instrument.

### Main specifications <sup>(1)</sup>

Calibre	150 A
Measurement range	2 A...150 A
Accuracy of primary current in %	≤ 2.5 % + 0.15 A (load 1 Ω) ≤ 3 % + 0.15 A (load 10 Ω)
Phase shift	not specified
Output signal	1 mA AC/A AC (1000/1) (150 mA for 150 A)

#### Output:

Double-insulated cable 1.5 m long, terminated by 2 insulated elbowed male banana connectors Ø 4 mm

#### Bandwidth:

48 Hz...500 Hz

#### Clamping capacity:

Cable Ø max 10 mm

### Electrical specifications

#### Load impedance:

≤ 10 Ω

#### Maximum currents:

I < 150 A permanent from 48 Hz...500 Hz

#### Influence of temperature:

≤ 0.2 % per 10 °K

#### Influence of adjacent conductor:

≤ 2 mA/A at 50 Hz

#### Influence of conductor position in jaws:

≤ 0.1 % at 50/60 Hz

#### Influence of frequency:

≤ 2 % from 65 Hz to 500 Hz

#### Maximum output voltage (secondary open):

30 V

### Mechanical specifications

#### Operating temperature:

-10 °C to +50 °C

#### Storage temperature:

-40 °C to +80 °C

#### Relative humidity for operation:

From 0 to 85 % RH with a linear decrease above 35 °C

#### Operating altitude:

0 to 2,000 m

#### Casing protection rating (leakproofing):

IP40 <sup>(2)</sup> (EN 60529 Ed. 1992)

#### Drop test:

1.5 m (IEC 68-2-32)

#### Shock resistance:

100 g / 6 ms / half-period (IEC 68-2-27)

#### Vibration resistance <sup>(3)</sup>:

5-15 Hz (1.5 mm), 15-25 Hz (1 mm),  
25-55 Hz (0.25 mm) (IEC 68-2-6)

#### Self-extinguishing capability:

casing UL94 V2

#### Dimensions:

130 x 37 x 25 mm

#### Weight:

approx. 180 g

#### Colour:

Black casing

### Safety specifications

#### Electrical safety:

Instrument with double insulation or reinforced insulation between the primary, the secondary and the grippable part located under the guard as per EN 61010-1 Ed. 2:2001, EN 61010-2-031 Ed. 2002 & EN 61010-2-032 Ed. 2003

- 600 V category III, pollution degree 2
- 300 V category IV, pollution degree 2

#### Electromagnetic compatibility:

CE-certified equipment compliant with standard EN 61326-1 (Ed.97) + A1 (Ed.98) + A2 (Ed.01)

- Emission: stipulations for class B equipment (domestic use).
- Immunity: stipulations for equipment used intermittently on industrial sites.

(1) Conditions of reference: 23 °C ± 3 °K, 20 °C to 75 % RH, sinusoidal signal with frequency of 48 Hz to 65 Hz, distortion factor < 1 % with no DC component, external DC magnetic field < 40 A/m, no external AC magnetic field, no external conductor with circulating current, conductor centred for measurement, measurement instrument load impedance ≤ 10 Ω.

(2) With clamp closed.

(3) Vibrations expressed in mm peak, scanning of 1 octave/minute for 10 minutes on 3 axes.

To order	Reference
AC current clamp model MINI 01 with operating manual	P01105101Z



# Current clamp for AC current

## Model MINI 02

MINI series

Calibre	100 AAC
Sensitivity	1 mA/A (1000/1)

### Description

The MINI 02 current clamp, whose jaws are equipped with a high-performance magnetic material and a double coil, offers excellent linearity and improved performance.

Small and compact, it is ideal for measuring AC currents in low-power tertiary or industrial applications.

If a current is present in the conductor being clamped, the MINI 02 clamp is protected against voltage surges when it is disconnected from the measurement instrument.



### Main specifications <sup>(1)</sup>

Calibre	100 A
Measurement range	50 mA .. 100 A (load 1 Ω) 50 mA .. 90 A (load 10 Ω)
Accuracy of primary current in % (48 Hz to 10 kHz)	≤ 1 % + 0.02 A (load 1 Ω) ≤ 1.5 % + 0.01 A (load 10 Ω)
Phase shift (50 Hz to 60 Hz)	≤ 3° (load 1 Ω) ≤ 6° (load 10 Ω)
Output signal	1 mA AC/A AC (1000/1) (100 mA for 100 A)

#### Output:

Double-insulated cable 1.5 m long, terminated by 2 insulated elbowed male banana connectors Ø 4 mm

#### Bandwidth:

48 Hz ... 10 000 Hz

#### Clamping capacity:

Cable Ø max 10 mm

### Electrical specifications

#### Load impedance:

≤ 100 Ω

#### Influence of load impedance:

see curves

#### Maximum currents:

I < 100 A permanent from 48 Hz ... 10,000 Hz

#### Influence of temperature:

≤ 0.2 % per 10 °K

#### Influence of adjacent conductor:

≤ 2 mA/A at 50 Hz

#### Influence of conductor position in jaws:

≤ 0.1 % at 50/60 Hz

#### Influence of frequency:

≤ 2 % from 65 Hz to 10 kHz

#### Maximum output voltage (secondary open):

≤ 30 V

### Mechanical specifications

#### Operating temperature:

-10 °C to +50 °C

#### Storage temperature:

-40 °C to +80 °C

#### Relative humidity for operation:

From 0 to 85 % RH with a linear decrease above 35 °C

#### Operating altitude:

0 to 2,000 m

#### Casing protection rating (leakproofing):

IP40 <sup>(2)</sup> (EN 60529 Ed. 1992)

#### Drop test:

1.5 m (IEC 68-2-32)

#### Shock resistance:

100 g / 6 ms / half-period (IEC 68-2-27)

#### Vibration resistance <sup>(3)</sup>:

5-15 Hz (1.5 mm), 15-25 Hz (1 mm), 25-55 Hz (0.25 mm) (IEC 68-2-6)

#### Self-extinguishing capability:

Casing UL94 V2

#### Dimensions:

130 x 37 x 25 mm

#### Weight:

Approx. 180 g

#### Colour:

Black casing

### Safety specifications

#### Electrical safety:

Instrument with double insulation or reinforced insulation between the primary, the secondary and the grippable part located under the guard as per EN 61010-1 Ed. 2:2001, EN 61010-2-031 Ed. 2002 & EN 61010-2-032 Ed. 2003

- 600 V category III, pollution degree 2

- 300 V category IV, pollution degree 2

#### Electromagnetic compatibility:

CE-certified equipment compliant with standard EN 61326-1 (Ed.97) + A1 (Ed.98) + A2 (Ed.01)

- Emission: stipulations for class B equipment (domestic use).

- Immunity: stipulations for equipment used intermittently on industrial sites.

# Current clamp for AC current

## Model MINI 02

MINI series

### Curves at 50 Hz

Typical linearity error for loads of 1, 10, 30 and 100 Ω

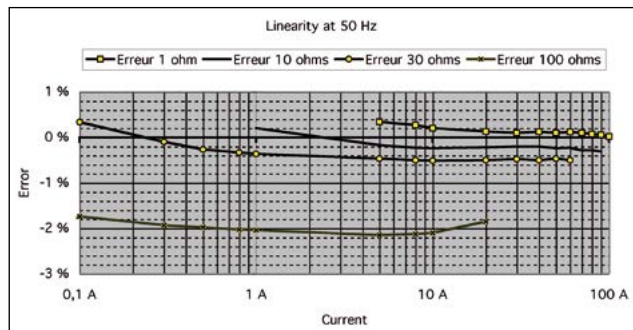

Typical phase shift for loads of 1, 10, 30 and 100 Ω

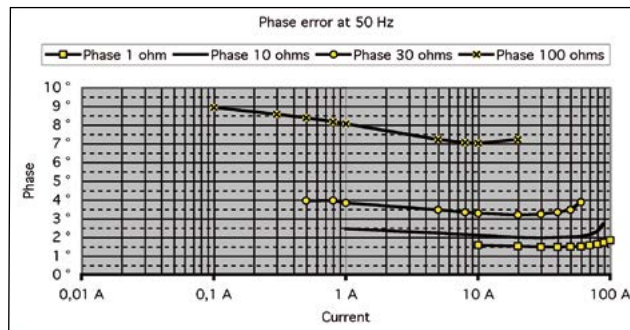

### Frequency response at 10 A

Typical linearity error for loads of 1, 10, 30 and 100 Ω

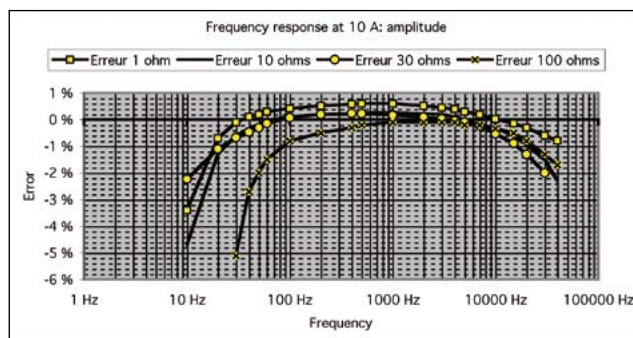

Typical phase shift for loads of 1, 10, 30 and 100 Ω

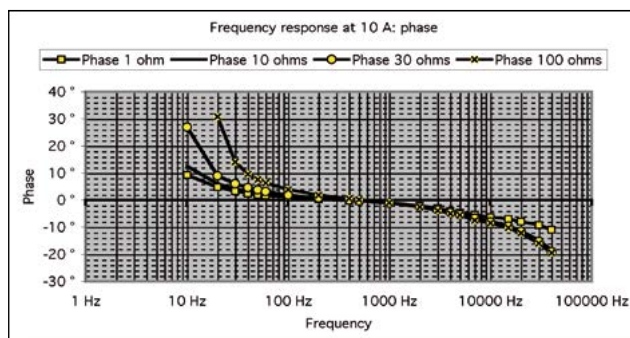

(1) Conditions of reference: 23 °C ± 3 °K, 20 °C to 75 % RH, sinusoidal signal with frequency of 48 Hz at 10 kHz, distortion factor < 1 % with no DC component, external DC magnetic field < 40 A/m, no external AC magnetic field, no external conductor with circulating current, conductor centred for measurement, measurement instrument load impedance ≤ 10 Ω.

(2) With clamp closed.

(3) Vibrations expressed in mm peak, scanning of 1 octave/minute for 10 minutes on 3 axes.

To order	Reference
AC current clamp model <b>MINI 02</b> with operating manual	P01105102Z

# Current clamp for AC current

## Model MINI 03

MINI series

Calibre	100 AAC
Sensitivity	1 mV/A

### Description

Small and compact, the MINI 03 current clamp is the ideal complement for any multimeter to measure AC currents in low-power tertiary or industrial applications. When used with an AC voltmeter, it allows you to directly read the current measured on the voltmeter.



### Main specifications <sup>(1)</sup>

Calibre	100 A
Measurement range	1 A...100 A
Accuracy of primary current in %	≤ 2 % + 50 mA
Phase shift	not specified
Output signal	1 mVAC/AAC (100 mV for 100 A)

#### Output:

Double-insulated cable 1.5 m long, terminated by 2 insulated elbowed male banana connectors Ø 4 mm

#### Bandwidth:

48 Hz...500 Hz

#### Clamping capacity:

Cable Ø max 10 mm

### Electrical specifications

#### Maximum currents:

I < 150 A permanent from 48 Hz...500 Hz

#### Influence of temperature:

≤ 0.2 % per 10 °K

#### Influence of adjacent conductor:

≤ 2 mA/A at 50 Hz

#### Influence of conductor position in jaws:

≤ 0.1 % at 50/60 Hz

#### Influence of frequency:

≤ 1 % from 65 Hz to 500 Hz

### Mechanical specifications

#### Operating temperature:

-10 °C to +50 °C

#### Storage temperature:

-40 °C to +80 °C

#### Relative humidity for operation:

from 0 to 85 % RH with a linear decrease above 35 °C

#### Operating altitude:

0 to 2,000 m

#### Casing protection rating (leakproofing):

IP40 <sup>(2)</sup> (EN 60529 Ed. 1992)

#### Drop test:

1.5 m (IEC 68-2-32)

#### Shock resistance:

100 g / 6 ms / half-period (IEC 68-2-27)

#### Vibration resistance <sup>(3)</sup>:

5-15 Hz (1.5 mm), 15-25 Hz (1 mm),

25-55 Hz (0.25 mm) (IEC 68-2-6)

#### Self-extinguishing capability:

Casing UL94 V2

#### Dimensions:

130 x 37 x 25 mm

#### Weight:

Approx. 180 g

#### Colour:

Black casing

### Safety specifications

#### Electrical safety:

Instrument with double insulation or reinforced insulation between the primary, the secondary and the grippable part located under the guard as per EN 61010-1 Ed. 2:2001, EN 61010-2-031 Ed. 2002 & EN 61010-2-032 Ed. 2003

- 600 V category III, pollution degree 2

- 300 V category IV, pollution degree 2

#### Electromagnetic compatibility:

CE-certified equipment compliant with standard EN 61326-1 (Ed. 97) + A1 (Ed. 98) + A2 (Ed. 01)

- Emission: stipulations for class B equipment (domestic use).

- Immunity: stipulations for equipment used intermittently on industrial sites.

(1) Conditions of reference: 23 °C ± 3 °K, 20 °C to 75 % RH, sinusoidal signal with frequency of 48 Hz to 65 Hz, distortion factor < 1 % with no DC component, external DC magnetic field < 40 A/m, no external AC magnetic field, no external conductor with circulating current, conductor centred for measurement, measurement instrument load impedance ≥ 10 kΩ.

(2) With clamp closed.

(3) Vibrations expressed in mm peak, scanning of 1 octave/minute for 10 minutes on 3 axes.

To order	Reference
AC current clamp model MINI 03 with operating manual	P01105103Z

# Current clamp for AC current

## Model MINI 05

MINI series

Calibre	10 A AC	100 A AC
Sensitivity	1 mV/mA	1 mV/A

### Description

Small and compact, the MINI 05 current clamp is the ideal complement for any multimeter to measure AC currents in low-power tertiary or industrial applications. With its 2 calibres, it offers excellent resolution for measuring AC currents from 5 mA to 100 A.



### Main specifications <sup>(1)</sup>

Calibre	10 A	100 A
Measurement range	5 mA...10 A	1 A...100 A
Accuracy of primary current in %	≤ 3 % + 0.15 mA	≤ 2 % + 50 mA
Phase shift	not specified	
Output signal	1 mVAC/mAAC (10 V for 10 A)	1 mVAC/AAC (100 mV for 100 A)

#### Output:

Double-insulated cable 1.5 m long, terminated by 2 insulated elbowed male banana connectors Ø 4 mm

#### Bandwidth:

48 Hz...500 Hz

#### Clamping capacity:

Cable Ø max 10 mm

### Electrical specifications

#### Maximum currents:

■ 100 A calibre

I < 150 A permanent from 48 Hz...500 Hz

■ 10 A calibre

I < 15 A permanent from 48 Hz...500 Hz

#### Influence of temperature:

≤ 0.2 % per 10 °K

#### Influence of adjacent conductor:

≤ 2 mA/A at 50 Hz

#### Influence of conductor position in jaws:

≤ 0.1 % at 50/60 Hz

#### Influence of frequency:

■ 100 A calibre:

≤ 1 % from 65 Hz to 500 Hz

■ 10 A calibre:

≤ 3 % from 65 Hz to 500 Hz

### Mechanical specifications

#### Operating temperature:

-10 °C to +50 °C

#### Storage temperature:

-40 °C to +80 °C

#### Relative humidity for operation:

from 0 to 85 % RH with a linear decrease above 35 °C

#### Operating altitude:

0 to 2,000 m

#### Casing protection rating (leakproofing):

IP40 <sup>(2)</sup> (EN 60529 Ed. 1992)

#### Drop test:

1.5 m (IEC 68-2-32)

#### Shock resistance:

100 g / 6 ms / half-period (IEC 68-2-27)

#### Vibration resistance <sup>(3)</sup>:

5-15 Hz (1.5 mm), 15-25 Hz (1 mm), 25-55 Hz (0.25 mm) (IEC 68-2-6)

#### Self-extinguishing capability:

casing UL94 V2

#### Dimensions:

130 x 37 x 25 mm

#### Weight:

Approx. 180 g

#### Colour:

Black casing

### Safety specifications

#### Electrical safety:

Instrument with double insulation or reinforced insulation between the primary, the secondary and the grippable part located under the guard as per EN 61010-1 Ed. 2:2001, EN 61010-2-031 Ed. 2002 & EN 61010-2-032 Ed. 2003

- 600 V category III, pollution degree 2

- 300 V category IV, pollution degree 2

#### Electromagnetic compatibility:

CE-certified equipment compliant with standard EN 61326-1 (Ed. 97) + A1 (Ed. 98) + A2 (Ed. 01)

- Emission: stipulations for class B equipment (domestic use).

- Immunity: stipulations for equipment used intermittently on industrial sites.

(1) Conditions of reference: 23 °C ± 3 °K, 20 °C to 75 % RH, sinusoidal signal with frequency of 48 Hz to 65 Hz, distortion factor < 1 % with no DC component, external DC magnetic field < 40 A/m, no external AC magnetic field, no external conductor with circulating current, conductor centred for measurement, measurement instrument load impedance ≥ 1 MΩ (10 A calibre) & ≥ 10 kΩ (100 A calibre).

(2) With clamp closed.

(3) Vibrations expressed in mm peak, scanning of 1 octave/minute for 10 minutes on 3 axes.

To order	Reference
AC current clamp model MINI 05 with operating manual	P01105105Z

# Current clamp for AC current

## Model MINI 09

Calibre	150 AAC
Sensitivity	100 mVDC / A AC

### ■ Description

Small and compact, the MINI 09 current clamp is the ideal complement for any multimeter to measure AC currents in low-power tertiary or industrial applications. Its DC voltage output helps to overcome the low sensitivity of certain AC measurement instruments.

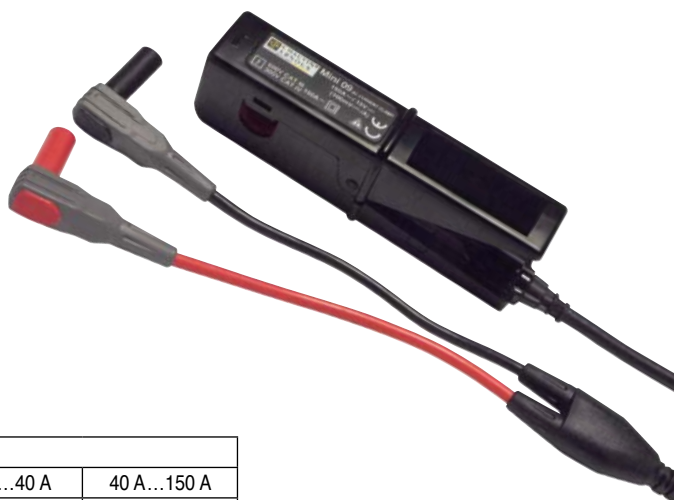

### ■ Main specifications <sup>(1)</sup>

Calibre	150 A			
Measurement range	1 A...5 A	5 A...15 A	15 A...40 A	40 A...150 A
Accuracy of primary current in %	≤ 10 % + 0.2 A	≤ 6 % + 0.2 A	≤ 3 % + 0.2 A	≤ 4 %
Phase shift	not specified			
Output signal	100 mVDC / AAC (15 VDC for 150 A)			

#### Output:

Double-insulated cable 1.5 m long, terminated by 2 insulated elbowed male banana connectors Ø 4 mm

#### Bandwidth:

48 Hz...500 Hz

#### Clamping capacity:

Cable Ø max 10 mm

### ■ Electrical specifications

#### Maximum currents:

I < 150 A permanent from 65 Hz...500 Hz

#### Influence of temperature:

≤ 0.2 % per 10 °K

#### Influence of adjacent conductor:

≤ 2 mA/A at 50 Hz

#### Influence of conductor position in jaws:

≤ 0.1 % at 50/60 Hz

#### Influence of frequency:

≤ 3 % from 65 Hz to 500 Hz

### ■ Mechanical specifications

#### Operating temperature:

-10 °C to +50 °C

#### Storage temperature:

-40 °C to +80 °C

#### Relative humidity for operation:

0 to 85 % RH decreasing linearly above 35 °C

#### Operating altitude:

0 to 2,000 m

#### Casing protection rating (leakproofing):

IP40 <sup>(2)</sup> (EN 60529 Ed. 1992)

#### Drop test:

1.5 m (IEC 68-2-32)

#### Shock resistance:

100 g / 6 ms / half-period (IEC 68-2-27)

#### Vibration resistance <sup>(3)</sup>:

5-15 Hz (1.5 mm), 15-25 Hz (1 mm), 25-55 Hz (0.25 mm) (IEC 68-2-6)

#### Self-extinguishing capability:

Casing UL94 V2

#### Dimensions:

130 x 37 x 25 mm

#### Weight:

Approx. 180 g

#### Colour:

Black casing

### ■ Safety specifications

#### Electrical safety:

Instrument with double insulation or reinforced insulation between the primary, the secondary and the grippable part located under the guard as per EN 61010-1 Ed. 2:2001, EN 61010-2-031 Ed. 2002 & EN 61010-2-032 Ed. 2003  
 - 600 V category III, pollution degree 2  
 - 300 V category IV, pollution degree 2

#### Electromagnetic compatibility:

CE-certified equipment compliant with standard EN 61326-1 (Ed. 97) + A1 (Ed. 98) + A2 (Ed. 01)  
 - Emission: stipulations for class B equipment (domestic use).  
 - Immunity: stipulations for equipment used intermittently on industrial sites.

(1) Conditions of reference: 23 °C ± 3 °K, 20 % to 75 % RH, sinusoidal signal with frequency of 48 Hz to 65 Hz, distortion factor < 1 % with no DC component, external DC magnetic field < 40 A/m, no external AC magnetic field, no external conductor with circulating current, conductor centred for measurement, measurement instrument load impedance ≥ 50 kΩ.

(2) With clamp closed.

(3) Vibrations expressed in mm peak, scanning of 1 octave/minute for 10 minutes on 3 axes.

To order	Reference
AC current clamp model MINI 09 with operating manual	P01105109Z



## MN series

These ergonomic mini-clamps are designed to make light work of measuring low and medium currents from 0.01 A to 240 AAC.

The shape of the jaws makes 'hooking' onto cables easy, even in areas of restrictive access. The jaws can grip conductors up to 20 mm in diameter.

Depending on the particular model, they have one or two calibres. The output is via either jack sockets or a lead with 4 mm Ø plugs, hence these clamps are compatible with all multimeters and testers on the market.

There are two types of MN series clamps available. The first kind operates as a current transformer (ratio 1000/1) and gives a current output (mA) for use with any tester with current calibres.

The second type gives a voltage output (DC or AC depending on the model) proportional to the measured current (1, 10, 100 or 1000 mV/A). This voltage output means that, even with testers without any current calibres, it is possible to measure currents by means of the DC or AC voltage calibres.

There are specific models in the MN series that have been designed with particular applications in mind such as measurement on current transformer outputs, on oscilloscopes and even of leakage currents.

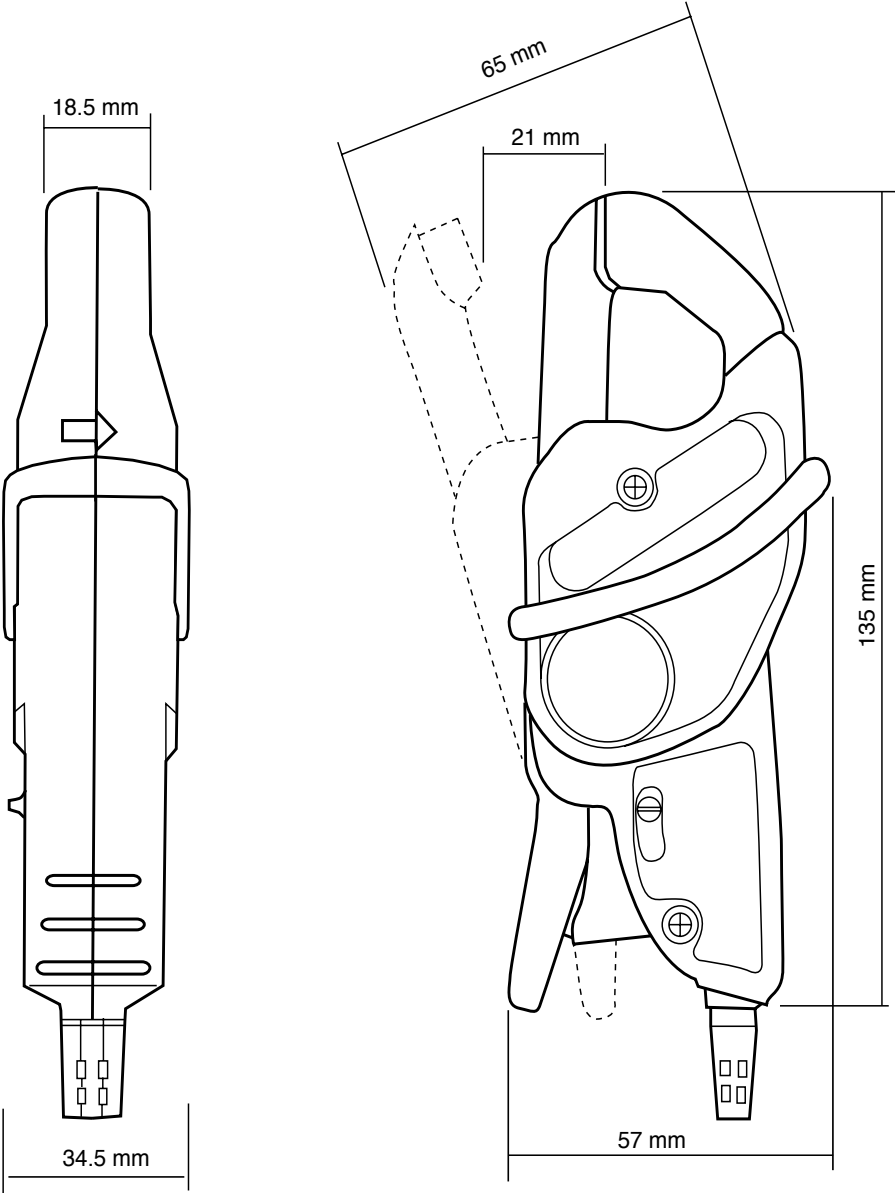

# Current clamps for AC current

## Models MN08 and MN09

MN series

Current	200 A AC
Ratio	1000/1
Output	1 mA/A

### ■ Electrical specifications

**Current calibre:**

0.5 A AC ... 240 A AC

**Current transformation ratio:**

1000/1

**Output signal:**

1 mA AC/A AC (240 mA for 240 A)

**Accuracy and phase shift<sup>(1)</sup>:**

Primary current	0.5 A...10 A	10 A...40 A	40 A...100 A	100 A...240 A
% Accuracy of output signal	≤ 3 % + 0.5 mA	≤ 2.5 % + 0.5 mA	≤ 2 % + 0.5 mA	≤ 1 % + 0.5 mA
Phase shift	not specified	≤ 5°	≤ 3°	≤ 2.5°

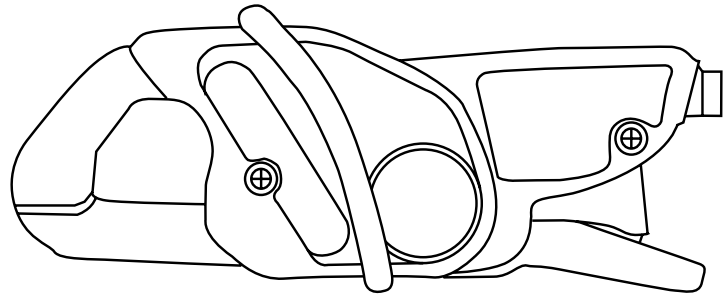

**Bandwidth:**

40 Hz ... 10 kHz

**Crest factor:**

3 for a current of 200 A rms

**Maximum currents:**

200 A continuous for a frequency ≤ 3 kHz (limitation proportional to the inverse of one third of frequency beyond)

**Load impedance:**

≤ 10 Ω

**Operating voltage:**

600 V rms

**Common mode voltage:**

600 V category III and pollution degree 2

**Influence of adjacent conductor:**

≤ 15 mA/A at 50 Hz

**Influence of conductor position in jaws:**

≤ 0.5 % of output signal at 50/60 Hz

**Load influence:** 0.2 ... 10 Ω

< 0.5 % on measurement

< 0.5° on phase

**Influence of frequency<sup>(2)</sup>:**

< 3 % of output signal from 40 Hz ... 1 kHz

< 12 % of output signal from 1 kHz ... 10 kHz

**Influence of crest factor:**

< 4 % of output signal for a crest factor of 3 and current 200 of A rms

### ■ Mechanical specifications

**Operating temperature:**

-10 °C to +55 °C

**Storage temperature:**

-40 °C to +70 °C

**Influence of temperature:**

≤ 0.15 % of output signal per 10 °K

**Relative humidity for operation:**

0 to 85 % RH decreasing linearly above 35 °C

**Influence of relative humidity:**

< 0.2 % of output signal from 10 % to 85 % RH

**Operating altitude:**

0 to 2,000 m

**Max. jaw opening:** 20 mm

**Clamping capacity:**

Cable: Ø max 20 mm

Busbar: 1 busbar of 20 x 5 mm

**Casing protection rating:**

IP40 (IEC 529)

**Drop test:** 1 m (IEC 68-2-32)

**Shock resistance:**

100 g (IEC 68-2-27)

**Vibration resistance:**

10/55/10 Hz, 0.15 mm (IEC 68-2-6)

**Self-extinguishing capability:**

Casing: UL94 V2

Jaws: UL94 V0

**Dimensions:**

135 x 51 x 30 mm

**Weight:**

180 g

**Colours:**

Dark grey case with red jaws

**Output:**

■ MN08:  
Safety sockets (4 mm)

■ MN09:  
1.5 m two-wire lead with double or reinforced insulation terminated by 2 elbowed male safety plugs (4 mm)

### ■ Safety specifications

**Electrical safety:**

Instrument with double insulation or reinforced insulation between the primary, the secondary and the grippable part located under the guard as per IEC 1010-1 & IEC 1010-2-032.

- 600 V category III, pollution degree 2
- 300 V category IV, pollution degree 2

**Electromagnetic compatibility (EMC):**

EN 50081-1: class B

EN 50082-2:

- Electrostatic discharge: IEC 1000-4-2
- Radiated field: IEC 1000-4-3
- Fast transients: IEC 1000-4-4
- Magnetic field at 50/60 Hz: IEC 1000-4-8

(1) Conditions of reference: 23 °C ± 3 °K, 20 to 70 % RH, sinusoidal signal with frequency of 48 Hz to 65 Hz, external magnetic field < 40 A/m, no DC components, no external conductor with circulating current, conductor centred for measurement, 1 Ω load.

(2) Out of reference domain.

To order	Reference
AC current clamp model <b>MN08</b> with operating manual	P01120401
AC current clamp model <b>MN09</b> with operating manual	P01120402



# Current clamps for AC current

## Models MN10 and MN11

MN series

Current	200 A AC
Ratio	1000/1
Output	1 mA/A

### ■ Description

An electronic voltage-limiting system protects output of clamp when operating, if the secondary circuit is opened.

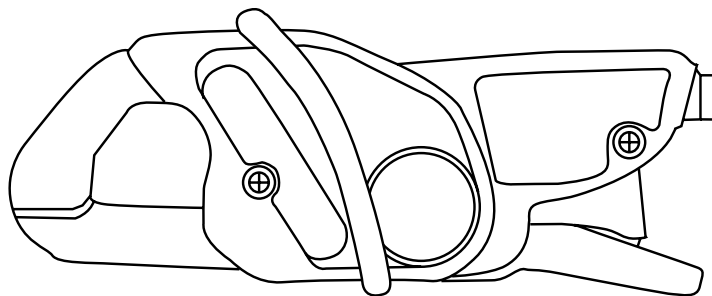

### ■ Electrical specifications

#### Current calibre:

0.5 A AC ... 240 A AC

#### Current transformation ratio:

1000/1

#### Output signal:

1 mA AC / A AC (240 mA for 240 A)

#### Accuracy and phase shift <sup>(1)</sup>:

Primary current	0.5 A...10 A	10 A...40 A	40 A...100 A	100 A...150 A	150 A...200 A	200 A...240 A
Accuracy in % of output signal	≤ 3 % + 0.5 mA	≤ 2.5 % + 0.5 mA	≤ 2 % + 0.5 mA	≤ 1 % + 0.5 mA	≤ 2 % + 0.5 mA	≤ 3 % + 0.5 mA
Phase shift	not specified	≤ 5°	≤ 3°	≤ 2.5°	≤ 2.5°	≤ 2.5°

#### Bandwidth:

40 Hz ... 10 kHz

#### Crest factor:

3 for a current of 200 Arms

#### Maximum currents:

200 A continuous for a frequency ≤ 3 kHz (limitation proportional to the inverse of one third of frequency beyond)

#### Load impedance:

≤ 10 Ω

#### Maximum output voltage (secondary open):

Limited to 8 V peak max.

#### Operating voltage:

600 Vrms

#### Common mode voltage:

600 V category III and pollution degree 2

#### Influence of adjacent conductor:

≤ 15 mA/A at 50 Hz

#### Influence of conductor position in jaws:

≤ 0.5 % of output signal at 50/60 Hz

#### Load influence: 0.2 ... 10 Ω

< 0.5 % on measurement

< 0.5° on phase

#### Influence of frequency <sup>(2)</sup>:

< 3 % of output signal from 40 Hz ... 1 kHz

< 12 % of output signal from 1 kHz ... 10 kHz

#### Influence of crest factor:

< 4 % of output signal for a crest factor of 3 and current of 200 A rms

### ■ Mechanical specifications

#### Operating temperature:

-10 °C to +55 °C

#### Storage temperature:

-40 °C to +70 °C

#### Influence of temperature:

≤ 0.15 % of output signal per 10 °K

#### Relative humidity for operation:

0 to 85 % RH decreasing linearly above 35 °C

#### Influence of relative humidity:

< 0.2 % of output signal from 10 % to 85 % RH

#### Operating altitude:

0 to 2,000 m

#### Max. jaw opening:

20 mm

#### Clamping capacity:

Cable: Ø max 20 mm

Busbar: 1 busbar of 20 x 5 mm

#### Casing protection rating:

IP40 (IEC 529)

#### Drop test:

1 m (IEC 68-2-32)

#### Shock resistance:

100 g (IEC 68-2-27)

#### Vibration resistance:

10/55/10 Hz, 0.15 mm (IEC 68-2-6)

#### Self-extinguishing capability:

Casing: UL94 V2

Jaws: UL94 V0

#### Dimensions:

135 x 51 x 30 mm

#### Weight:

180 g

#### Colours:

Dark grey case with red jaws

#### Output:

##### ■ MN10:

Safety sockets (4 mm)

##### ■ MN11:

1.5 m two-wire lead with double or reinforced insulation terminated by 2 elbowed male safety plugs (4 mm)

### ■ Safety specifications

#### Electrical safety:

Instrument with double insulation or reinforced insulation between the primary, the secondary and the grippable part located under the guard as per IEC 1010-1 & IEC 1010-2-032

- 600 V category III, pollution degree 2

- 300 V category IV, pollution degree 2

#### Electromagnetic compatibility (EMC):

EN 50081-1: class B

EN 50082-2:

- Electrostatic discharge: IEC 1000-4-2

- Radiated field: IEC 1000-4-3

- Fast transients: IEC 1000-4-4

- Magnetic field at 50/60 Hz: IEC 1000-4-8

(1) Conditions of reference: 23 °C ± 3 °K, 20 to 70 % RH, sinusoidal signal with frequency of 48 Hz to 65 Hz, external magnetic field < 40 A/m, no DC components, no external conductor with circulating current, conductor centred for measurement, 1 Ω load.

(2) Out of reference domain.

To order	Reference
AC current clamp model MN10 with operating manual	P01120403
AC current clamp model MN11 with operating manual	P01120404

# Current clamps for AC current

## Models MN12 and MN13

MN series

Current	200 A AC
Output	10 mV/A

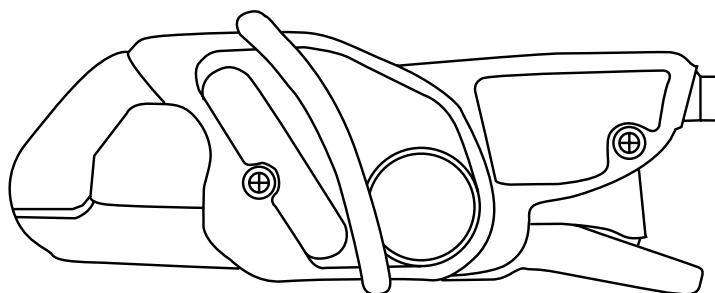

### Electrical specifications

**Current calibre:**

0.5 A AC ... 240 A AC

**Output signal:**

10 mV/AC/A AC (2.4 V for 240 A)

**Accuracy and phase shift <sup>(1)</sup>:**

Primary current	0.5 A...10 A	10 A...40 A	40 A...100 A	100 A...240 A
% Accuracy of output signal	≤ 3.5 % + 5 mV	≤ 2.5 % + 5 mV	≤ 2 % + 5 mV	≤ 1 % + 5 mV
Phase shift	not specified	≤ 5°	≤ 3°	≤ 2.5°

**Bandwidth:**

40 Hz ... 10 kHz

**Crest factor:**

3 for a current of 200 Arms

**Maximum currents:**

200 A continuous for a frequency ≤ 1 kHz (derating proportional to the inverse of frequency beyond)

**Load impedance:**

> 1 MΩ

**Operating voltage:**

600 V rms

**Common mode voltage:**

600 V category III and pollution degree 2

**Influence of adjacent conductor:**

≤ 15 mA/A at 50 Hz

**Influence of conductor position in jaws:**

≤ 0.5 % of output signal at 50/60 Hz

**Influence of frequency <sup>(2)</sup>:**

< 3 % of output signal from 40 Hz ... 1 kHz  
< 12 % of output signal from 1 kHz ... 10 kHz

**Influence of crest factor:**

< 3 % of output signal for a crest factor of 3 and current of 200 A rms

### Mechanical specifications

**Operating temperature:**

-10 °C to +55 °C

**Storage temperature:**

-40 °C to +70 °C

**Influence of temperature:**

≤ 0.15 % of output signal per 10 °K

**Relative humidity for operation:**

0 to 85 % RH decreasing linearly above 35 °C

**Influence of relative humidity:**

< 0.2 % of output signal from 10 % to 85 % RH

**Operating altitude:**

0 to 2,000 m

**Max. jaw opening:**

20 mm

**Clamping capacity:**

Cable: Ø max 20 mm  
Busbar: 1 busbar of 20 x 5 mm

**Casing protection rating:**

IP40 (IEC 529)

**Drop test:** 1 m (IEC 68-2-32)

**Shock resistance:**

100 g (IEC 68-2-27)

**Vibration resistance:**

10/55/10Hz, 0.15 mm (IEC 68-2-6)

**Self-extinguishing capability:**

Casing: UL94 V2  
Jaws: UL94 V0

**Dimensions:**

135 x 51 x 30 mm

**Weight:**

180 g

**Colours:**

Dark grey case with red jaws

**Output:**

■ MN12:

Safety sockets (4 mm)

■ MN13:

1.5 m two-wire lead with double or reinforced insulation terminated by 2 elbowed male safety plugs (4 mm)

### Safety specifications

**Electrical safety:**

Instrument with double insulation or reinforced insulation between the primary, the secondary and the grippable part located under the guard as per IEC 1010-1 & IEC 1010-2-032

- 600 V category III, pollution degree 2

- 300 V category IV, pollution degree 2

**Electromagnetic compatibility (EMC):**

EN 50081-1: class B

EN 50082-2:

- Electrostatic discharge: IEC 1000-4-2

- Radiated field: IEC 1000-4-3

- Fast transients: IEC 1000-4-4

- Magnetic field at 50/60 Hz: IEC 1000-4-8

(1) Conditions of reference: 23 °C ± 3 °K, 20 to 70 % RH, sinusoidal signal with frequency of 48 Hz to 65 Hz, external magnetic field < 40 A/m, no DC components, no external conductor with circulating current, conductor centred for measurement, load impedance > 1 MΩ.

(2) Out of reference domain

To order	Reference
AC current clamp model MN12 with operating manual	P01120405
AC current clamp model MN13 with operating manual	P01120406



## Model MN21

Current	200 A AC
Ratio	1000/1
Output	1 mA/A

### Description

An electronic voltage-limiting system protects output of clamp when operating, if the secondary circuit is opened.

### Electrical specifications

**Current calibre:**

0.1 A AC ... 240 A AC

**Current transformation ratio:** 1000/1

**Output signal:**

1 mA AC/A AC (240 mA for 240 A)

**Accuracy and phase shift <sup>(1)</sup>:**

Primary current	0.1 A...10 A	1 A...20 A	20 A...80 A	80 A...150 A	150 A...200 A
% Accuracy of output signal	≤ 2 % + 20 μA	≤ 1 % + 20 μA	≤ 1 %	≤ 2 %	≤ 4 %
Phase shift	not specified	≤ 2°	≤ 1.5°	≤ 1.5°	≤ 2°

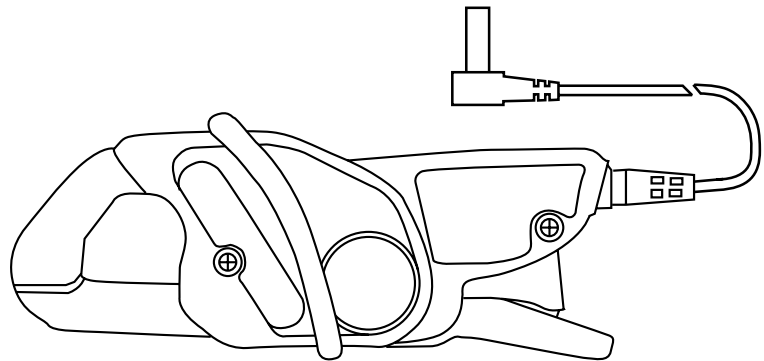

**Bandwidth:**

40 Hz ... 10 kHz

**Crest factor:**

5 for a current of 280 A peak

**Maximum currents:**

200 A continuous for a frequency ≤ 3 kHz (limitation proportional to the inverse of one third of frequency beyond)

**Load impedance:**

≤ 10 Ω

**Maximum output voltage (secondary open):**

Limited to 8 V peak max.

**Operating voltage:**

600 V rms

**Common mode voltage:**

600 V category III and pollution degree 2

**Influence of adjacent conductor:**

≤ 15 mA/A at 50 Hz

**Influence of conductor position in jaws:**

≤ 0.5 % of output signal at 50/60 Hz

**Load influence:**

0.1 ... 5 Ω

< 0.5 % on measurement

< 0.5° on phase

**Influence of frequency I<sub>p</sub> < 150 A <sup>(2)</sup>:**

< 5 % of output signal from 40 Hz ... 1 kHz

< 15 % of output signal from 1 kHz ... 10 kHz

add 5 % error if 150 A < I<sub>p</sub> < 200 A

**Influence of crest factor:**

< 3 % of output signal for crest factor < 5 with current < 280 A peak (50 Arms)

### Mechanical specifications

**Operating temperature:**

-10 °C to +55 °C

**Storage temperature:**

-40 °C to +70 °C

**Influence of temperature:**

≤ 0.20 % of output signal per 10 °K

**Relative humidity for operation:**

0 to 85 % RH decreasing linearly above 35 °C

**Influence of relative humidity:**

< 0.2 % of output signal from 10 % to 85 % RH

**Operating altitude:**

0 to 2,000 m

**Max. jaw opening:**

20 mm

**Clamping capacity:**

Cable: Ø max 20 mm

Busbar: 1 busbar of 20 x 5 mm

**Casing protection rating:**

IP40 (IEC 529)

**Drop test:** 1 m (IEC 68-2-32)

**Shock resistance:**

100 g (IEC 68-2-27)

**Vibration resistance:**

10/55/10 Hz, 0.15 mm (IEC 68-2-6)

**Self-extinguishing capability:**

Casing: UL94 V2

Jaws: UL94 V0

**Dimensions:**

135 x 51 x 30 mm

**Weight:**

180 g

**Colours:**

Dark grey case with red jaws

**Output:**

1.5 m two-wire lead with double or reinforced insulation terminated by 2 elbowed male safety plugs (4 mm)

### Safety specifications

**Electrical safety:**

Instrument with double insulation or reinforced insulation between the primary, the secondary and the grippable part located under the guard as per IEC 1010-1 & IEC 1010-2-032

- 600 V category III, pollution degree 2

- 300 V category IV, pollution degree 2

**Electromagnetic compatibility (EMC):**

EN 50081-1: class B

EN 50082-2:

- Electrostatic discharge: IEC 1000-4-2

- Radiated field: IEC 1000-4-3

- Fast transients: IEC 1000-4-4

- Magnetic field at 50 Hz: IEC 1000-4-8

(1) Conditions of reference: 23 °C ± 3 °K, 20 to 70 % RH, sinusoidal signal with frequency of 48 Hz to 65 Hz, external magnetic field < 40 A/m, no DC components, no external conductor with circulating current, conductor centred for measurement, 1 Ω load.

(2) Out of reference domain

To order	Reference
AC current clamp model MN21 with operating manual	P01120418

## Model MN23

Current	200 A AC
Output	10 mV/A

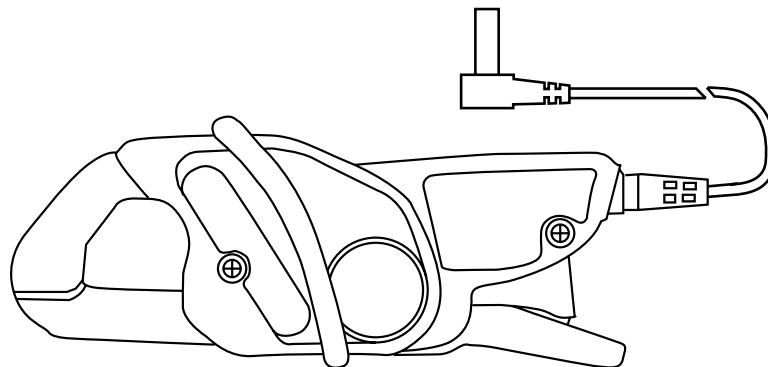

### Electrical specifications

**Current calibre:**

0.1 A AC ... 240 A AC

**Output signal:**

10 mVAC/A AC (2.4 V for 240 A)

**Accuracy and phase shift <sup>(1)</sup>:**

Primary current	0.1 A...1 A	1 A...20 A	20 A...80 A	80 A...150 A	150 A...200 A
% Accuracy of output signal	≤ 3 % + 200 μA	≤ 2 % + 200 μA	≤ 1 %	≤ 4 %	≤ 10 %
Phase shift	not specified	≤ 3°	≤ 2°	≤ 2.5°	≤ 3.5°

**Bandwidth:**

40Hz ... 10kHz

**Crest factor:**

5 for a current of 280 A peak

**Maximum currents:**

200 A continuous for a frequency ≤ 1 kHz (limitation proportional to the inverse of frequency beyond)

**Load impedance:**

> 1 MΩ

**Operating voltage:**

600 Vrms

**Common mode voltage:**

600 V category III and pollution degree 2

**Influence of adjacent conductor:**

≤ 15 mA/A at 50 Hz

**Influence of conductor position in jaws:**

≤ 0.5 % of output signal at 50/60 Hz

**Influence of frequency at IP < 100 A <sup>(2)</sup>:**

< 5 % of output signal from 40 Hz ... 1 kHz\*\*

< 15 % of output signal from 1 kHz ... 10kHz

\*\*Add 10 % error if 100 < IP < 200 A

**Influence of crest factor:**

< 3 % of output signal for a crest factor < 5 to a current < 280 A peak (50 A rms)

### Mechanical specifications

**Operating temperature:**

-10 °C to +55 °C

**Storage temperature:**

-40 °C to +70 °C

**Influence of temperature:**

≤ 0.20 % of output signal per 10 °K

**Relative humidity for operation:**

0 to 85 % RH decreasing linearly above 35 °C

**Influence of relative humidity:**

< 0.2 % of output signal from 10 % to 85 % RH

**Operating altitude:**

0 to 2,000 m

**Max. jaw opening:**

20 mm

**Clamping capacity:**

Cable: Ø max 20 mm

Busbar: 1 busbar of 20 x 5 mm

**Casing protection rating:**

IP40 (IEC 529)

**Drop test:** 1 m (IEC 68-2-32)

**Shock resistance:**

100 g (IEC 68-2-27)

**Vibration resistance:**

10/55/10 Hz, 0.15 mm (IEC 68-2-6)

**Self-extinguishing capability:**

Casing: UL94 V2

Jaws: UL94 V0

**Dimensions:**

135 x 51 x 30 mm

**Weight:**

180 g

**Colours:**

Dark grey case with red jaws

**Output:**

1.5 m two-wire lead with double or reinforced insulation terminated by 2 elbowed male safety plugs (4 mm)

### Safety specifications

**Electrical safety:**

Instrument with double insulation or reinforced insulation between the primary, the secondary and the grippable part located under the guard as per IEC 1010-1 & IEC 1010-2-032

- 606,5 V category III, pollution degree 2

- 306,5 V category IV, pollution degree 2

**Electromagnetic compatibility (EMC):**

EN 50081-1: class B

EN 50082-2:

- Electrostatic discharge: IEC 1000-4-2

- Radiated field: IEC 1000-4-3

- Fast transients: IEC 1000-4-4

- Magnetic field at 50 Hz:

IEC 1000-4-8

(1) Conditions of reference: 23 °C ± 3 °K, 20 to 70 % RH, sinusoidal signal with frequency of 48 Hz to 65 Hz, external magnetic field < 40 A/m, no DC components, no external conductor with circulating current, conductor centred for measurement, load impedance > 1 MΩ.

(2) Out of reference domain

To order	Reference
AC current clamp model MN23 with operating manual	P01120419

# Current clamps for AC current

## Models MN38 and MN39

MN series

Current	20 A AC	200 A AC
Output	100 mV/A	10 mV/A

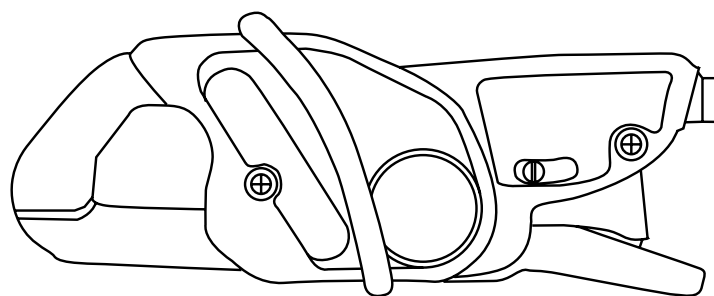

### Electrical specifications

#### Current calibres:

0.1 A AC...24 A AC

0.5 A AC...240 A AC

#### Output signal:

100 mVAC/AAC (2.4 V for 24 A)

10 mVAC/AAC (2.4 V for 240 A)

#### Accuracy and phase shift<sup>(1)</sup>:

Calibre	200 A				
	20 A	0.5 A...10 A	10 A...40 A	40 A...100 A	100 A...240 A
Primary current	0.1 A...20 A	0.5 A...10 A	10 A...40 A	40 A...100 A	100 A...240 A
% Accuracy of output signal	≤ 1 % + 50 mV	≤ 3 % + 5 mV	≤ 2.5 % + 5 mV	≤ 2 % + 5 mV	≤ 1 % + 5 mV
Phase shift	not specified	not specified	≤ 5°	≤ 3°	≤ 2.5°

#### Bandwidth:

40 Hz...10 kHz

#### Crest factor:

3 for a current of 200 Arms

#### Maximum currents:

200 A continuous for a frequency ≤ 1 kHz (limitation proportional to the inverse of frequency beyond)

#### Load impedance:

> 1 MΩ

#### Operating voltage:

600 V rms

#### Common mode voltage:

600 V category III and pollution degree 2

#### Influence of adjacent conductor:

≤ 15 mA/A at 50 Hz

#### Influence of conductor position in jaws:

≤ 0.5 % of output signal at 50/60 Hz

#### Influence of frequency<sup>(2)</sup>:

##### ■ 20 A calibre:

< 5 % of output signal from 40 Hz...1 kHz

< 15 % of output signal from 1 kHz...10 kHz

##### ■ 200 A calibre:

< 3 % of output signal from 40 Hz...1 kHz

< 12 % of output signal from 1 kHz...10 kHz

#### Influence of crest factor:

< 3 % of output signal for a crest factor of 3 and current of 200 A rms

### Mechanical specifications

#### Operating temperature:

-10 °C to +55 °C

#### Storage temperature:

-40 °C to +70 °C

#### Influence of temperature:

≤ 0.15 % of output signal per 10 °K

#### Relative humidity for operation:

0 to 85 % RH decreasing linearly above 35 °C

#### Influence of relative humidity:

< 0.2 % of output signal from 10 % to 85 % RH

#### Operating altitude:

0 to 2,000 m

#### Max. jaw opening:

20 mm

#### Clamping capacity:

Cable: Ø max 20 mm

Busbar: 1 busbar of 20 mm x 5 mm

#### Casing protection rating:

IP40 (IEC 529)

#### Drop test:

1 m (IEC 68-2-32)

#### Shock resistance:

100 g (IEC 68-2-27)

#### Vibration resistance:

10/55/10 Hz, 0.15 mm (IEC 68-2-6)

#### Self-extinguishing capability:

Casing: UL94 V2

Jaws: UL94 V0

#### Dimensions:

135 x 51 x 30 mm

#### Weight:

180 g

#### Colours:

Dark grey case with red jaws

#### Output:

■ MN38:  
Safety jacks (4 mm)

#### ■ MN39:

1.5 m two-wire lead with double or reinforced insulation terminated by 2 elbowed male safety plugs (4 mm)

### Safety specifications

#### Electrical safety:

Instrument with double insulation or reinforced insulation between the primary, the secondary and the grippable part located under the guard as per IEC 1010-1 & IEC 1010-2-032

- 600 V category III, pollution degree 2

- 300 V category IV, pollution degree 2

#### Electromagnetic compatibility (EMC):

EN 50081-1: class B

EN 50082-2:

- Electrostatic discharge: IEC 1000-4-2

- Radiated field: IEC 1000-4-3

- Fast transients: IEC 1000-4-4

- Magnetic field at 50/60 Hz: IEC 1000-4-8

(1) Conditions of reference: 23 °C ± 3 °K, 20 to 70 % RH, sinusoidal signal with frequency of 48 Hz to 65 Hz, external magnetic field < 40 A/m, no DC components, no external conductor with circulating current, conductor centred for measurement, load impedance > 1 MΩ.

(2) Out of reference domain

To order	Reference
AC current clamp model MN38 with operating manual	P01120407
AC current clamp model MN39 with operating manual	P01120408

## Model MN60 (insulated AC current probe)

Current	60 A peak	600 A peak
Output	100 mV/A	10 mV/A

### Description

This 200 A AC clamp enables easy display and measurement of "current" curves. It fits any oscilloscope since it has a coaxial lead with BNC plug. It produces a mV signal directly proportional to current. It offers 2 different sensitivities.

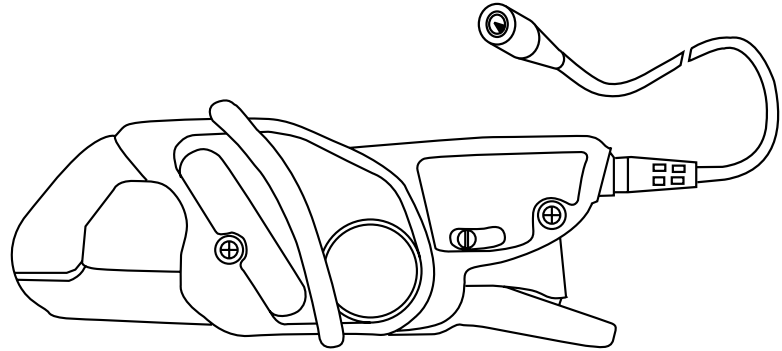

### Electrical specifications

#### Current calibres:

0.1 A AC ... 20 A AC (60 A peak)  
0.5 A AC ... 200 A AC (600 A peak)

#### Output signal:

100 mVAC/A AC (2 V for 20 A)  
10 mVAC/A AC (2 V for 200 A)

#### Accuracy and phase shift <sup>(1)</sup>:

Calibre	200 A				
	20 A	0.5 A...10 A	10 A...40 A	40 A...100 A	100 A...240 A
Primary current	0.1 A...20 A	0.5 A...10 A	10 A...40 A	40 A...100 A	100 A...240 A
Accuracy in % of output signal	≤ 2 % + 50 mV	≤ 3.5 % + 5 mV	≤ 3 % + 5 mV	≤ 2.5 % + 5 mV	≤ 1.5 % + 5 mV
Phase shift	not specified	not specified	≤ 6°	≤ 4°	≤ 3°

#### Bandwidth:

40 Hz ... 40 kHz (-3 dB) (depending on current value)

#### Rise/fall time from 10 % to 90 %:

- 20 A calibre: 7.4 μs
- 200 A calibre: 8.7 μs

#### 10 % delay time: 0.1 μs

#### Ampere second product:

- 20 A calibre: 25 A.s
- 200 A calibre: 2 A.s

#### Insertion impedance (at 400 Hz / 10 kHz)

- 20 A calibre: < 0.3 mΩ / < 7.2 mΩ
- 200 A calibre: < 1 mΩ / < 26 mΩ

#### Maximum currents:

200 A continuous for a frequency ≤ 3 kHz (limitation proportional to inverse of one third of frequency beyond)

#### Influence of temperature:

≤ 150 ppm / K or 0.15 % of output signal per 10 °K

#### Influence of relative humidity:

< 0.2 % of output signal

#### Influence of adjacent conductor:

≤ 15 mA/A at 50 Hz

#### Influence of DC current < 10 % of rated calibre superimposed on the rated current:

- 20 A calibre:  
For I DC < 2 A: influence < 0.5 %
- 200 A calibre:  
For I DC < 20 A: influence < 5 %

#### Influence of conductor position in jaws:

≤ 0.5 % of output signal at 50/60 Hz

#### Influence of frequency <sup>(2)</sup>:

- 20 A calibre:  
< 10 % of output signal from 40 Hz ... 1 kHz  
< 15 % of output signal from 1 kHz ... 10 kHz
- 200 A calibre:  
< 3 % of output signal from 40 Hz ... 1 kHz  
< 12 % of output signal from 1 kHz ... 10 kHz

#### Influence of crest factor:

< 3 % of output signal for a crest factor of 3 and current of 200 A rms

### Mechanical specifications

#### Operating temperature:

-10 °C to +55 °C

#### Storage temperature:

-40 °C to +70 °C

#### Relative humidity for operation:

0 to 85 % RH decreasing linearly above 35 °C

#### Operating altitude:

0 to 2,000 m

#### Max. jaw opening:

20 mm

#### Clamping capacity:

Cable: Ø max 20 mm  
Busbar: 1 busbar of 20 x 5 mm

#### Casing protection rating:

IP40 (IEC 529)

#### Drop test:

1 m (IEC 68-2-32)

#### Shock resistance:

100 g / 6 ms / half-period (IEC 68-2-27)

#### Protection against impacts:

IK04 0.5 J (EN 50102)

#### Vibration resistance:

10/55/10 Hz, 0.15 mm (IEC 68-2-6)

#### Self-extinguishing capability:

Casing: UL94 V2  
Jaws: UL94 V0

#### Dimensions:

128 x 49 x 28 mm

#### Weight:

180 g

#### Colours:

Dark grey case with red jaws

#### Output:

Coaxial cable 2 m long, terminated by an insulated BNC connector

### Safety specifications

#### Electrical safety:

Instrument with double insulation or reinforced insulation between the primary, the secondary and the grippable part located under the guard as per IEC 1010-1 & IEC 1010-2-032

- 600 V category III, pollution degree 2
- 300 V category IV, pollution degree 2

#### Electromagnetic compatibility (EMC):

EN 50081-1: class B  
EN 50082-2:

- Electrostatic discharge: IEC 1000-4-2  
4 kV level 2 performance criterion B  
8 kV in the air level 3 performance criterion B
- Radiated field: IEC 1000-4-3  
10 V/m performance criterion A
- Fast transients: IEC 1000-4-4  
1 kV level 2 performance criterion B  
2 kV level 3 performance criterion B
- Magnetic field at 50/60 Hz: IEC 1000-4-8  
field of 400 A/m at 50 Hz: < 1 A

# Oscilloscope clamp for AC current

## Model MN60 (insulated AC current probe)

MN series

### Curves at 50 Hz

200 A calibre

20 A calibre

Error on measurement

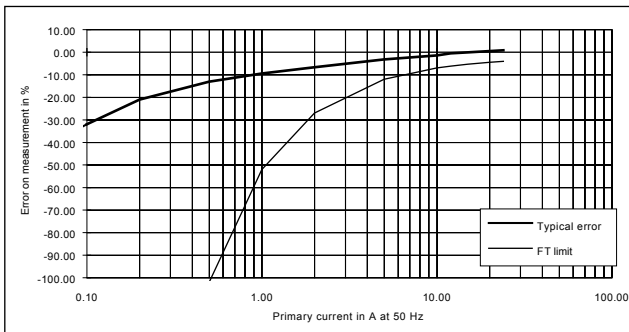
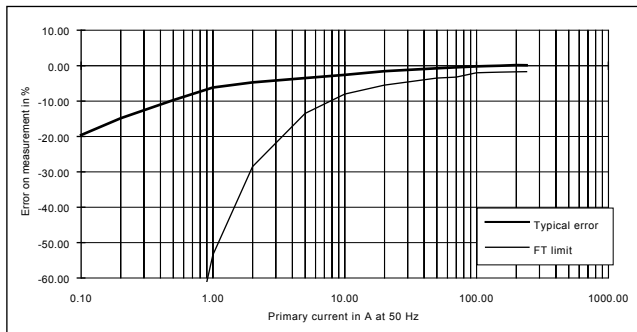

Phase shift

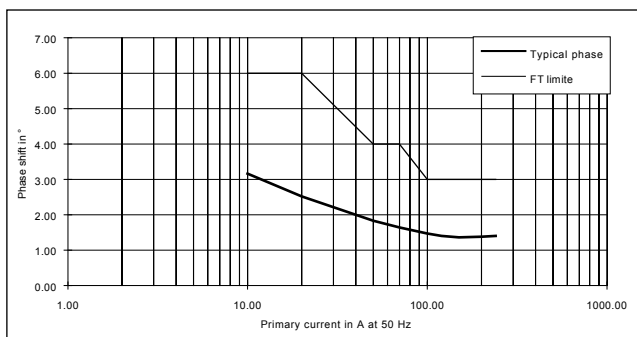

### Frequency response

200 A calibre

20 A calibre

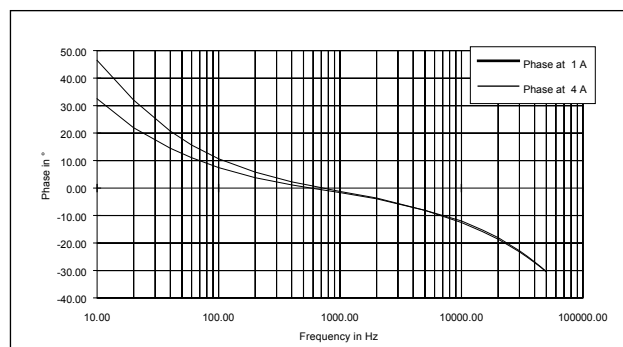
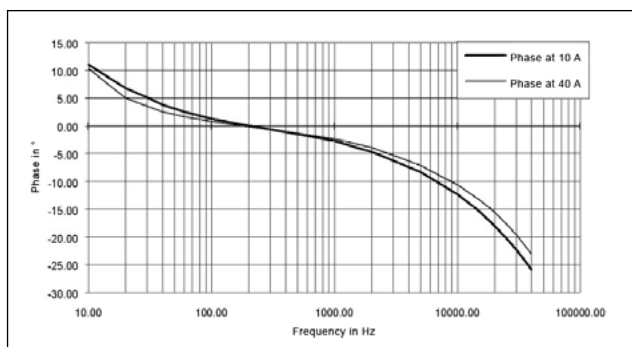
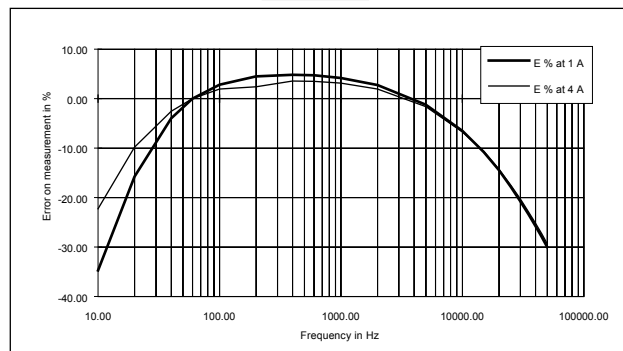
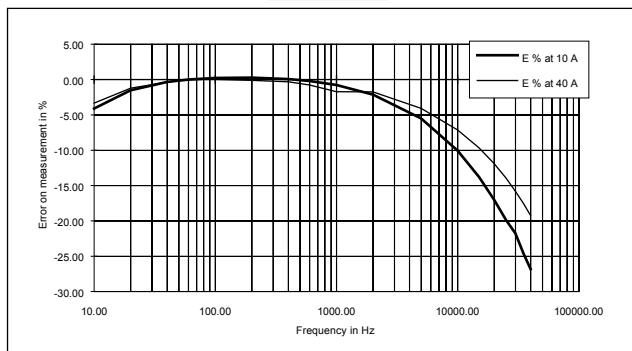



# Oscilloscope clamp for AC current

## Model MN60 (insulated AC current probe)

MN series

### Frequency response (cont.)

200 A calibre

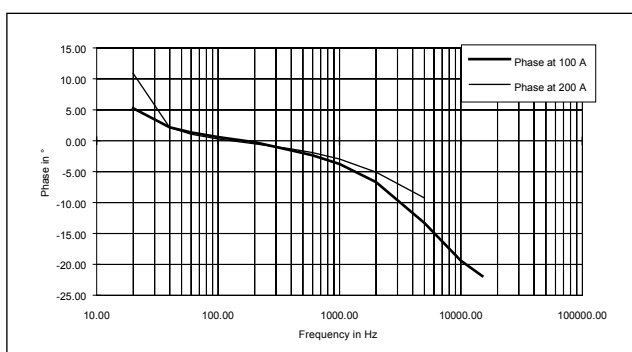
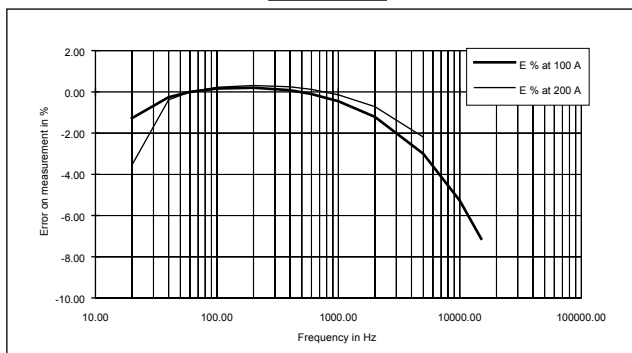

20 A calibre

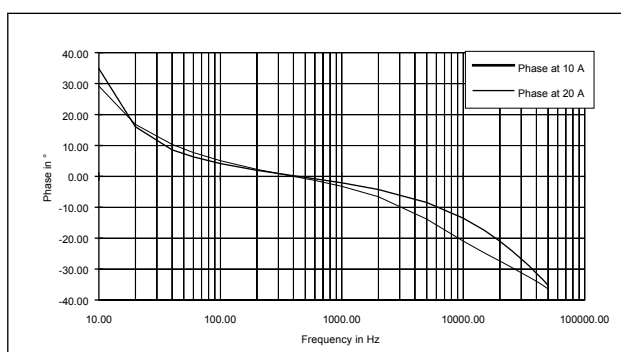
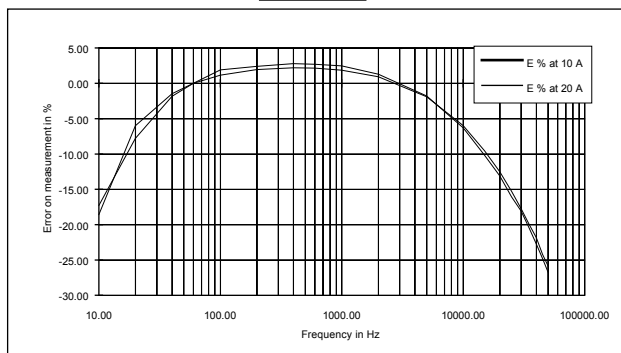

### Response to a square signal

200 A calibre

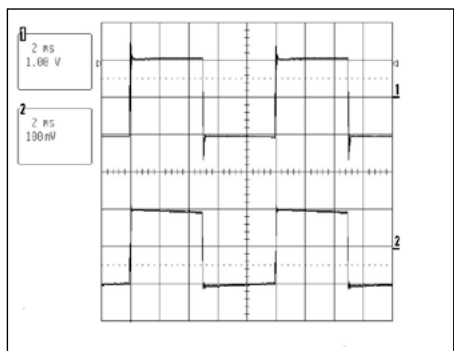
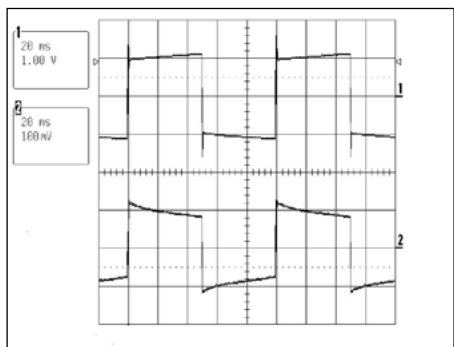

20 A calibre

10 A at 10 Hz

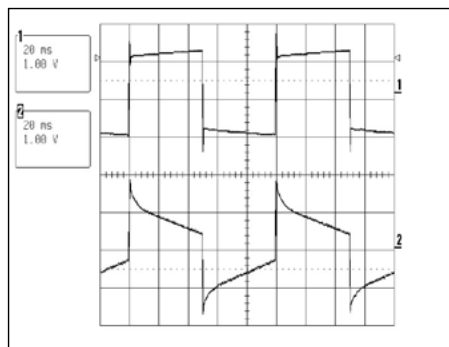

10 A at 100 Hz

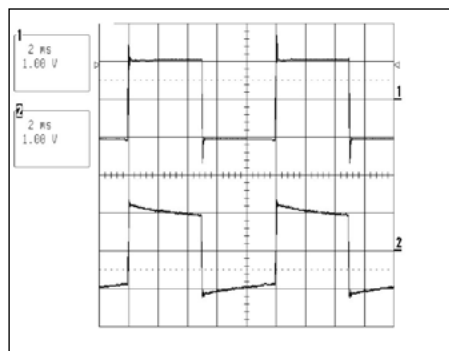

# Oscilloscope clamp for AC current

## Model MN60 (insulated AC current probe)

MN series

### ■ Response to a square signal (cont.)

200 A calibre

20 A calibre

10 A at 1 kHz

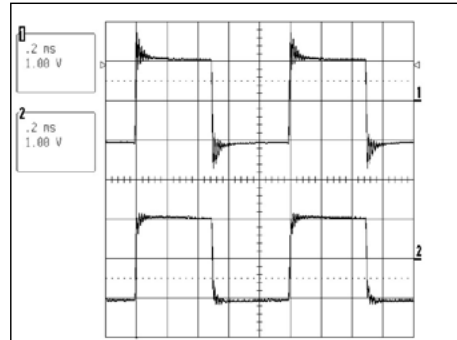
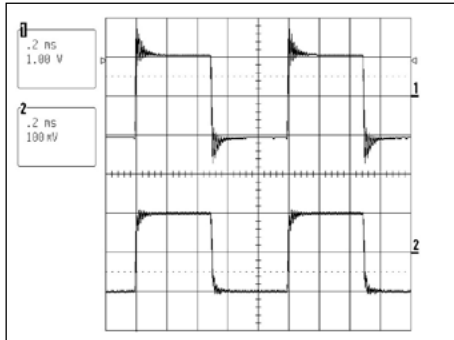

10 A at 10 kHz

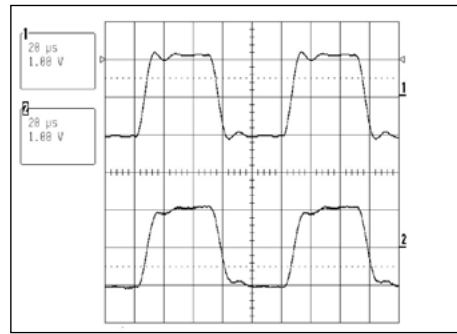
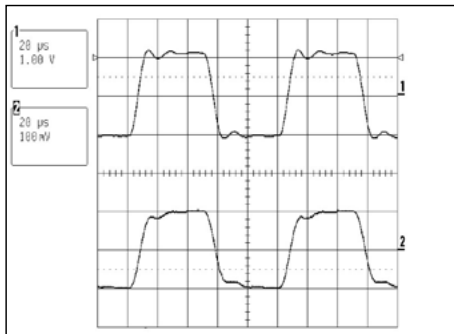

(1) Conditions of reference: 23 °C ± 3 °K, 20 % to 75 % RH, sinusoidal signal with frequency of 48 Hz at 1 kHz, external magnetic field < 40 A/m, no DC components, no external conductor with circulating current, conductor centred for measurement, load impedance > 1 MΩ and < 100 pF.

(2) Out of reference domain

To order	Reference
AC current clamp model <b>MN60</b> for oscilloscope with operating manual	P01120409

## Model MN71

Current	10 AAC
Output	100 mV/A

### Description

This clamp was specially designed to measure current on current transformer secondary circuits.

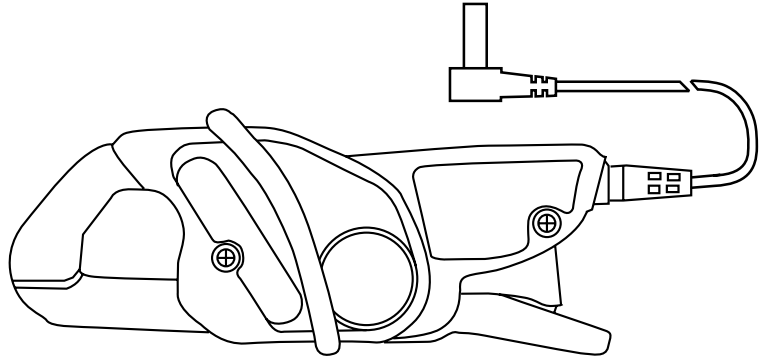

### Electrical specifications

**Current calibre:**

0.01 AAC ... 12 AAC

**Output signal:**

100 mVAC/AAC (1.2 V for 12 A)

**Accuracy and phase shift <sup>(1)</sup>:**

Primary current	0.01 A...0.1 A	0.1 A...1 A	1 A...5 A	5 A...12 A
Accuracy in % of output signal	≤ 3 % + 0.1 mV	≤ 2.5 %	≤ 1 %	
Phase shift	not specified	≤ 5°	≤ 3°	≤ 3°

**Bandwidth:**

40 Hz ... 10 kHz

**Crest factor:**

5 for a current of 40 A peak (8 Arms)

**Maximum currents:**

20 A continuous for a frequency ≤ 10 kHz (limitation proportional to the inverse of one tenth of frequency beyond)

**Load impedance:**

> 1 MΩ

**Operating voltage:**

600 V rms

**Common mode voltage:**

600 V category III and pollution degree 2

**Influence of adjacent conductor:**

< 15 mA/A at 50 Hz

**Influence of conductor position in jaws:**

< 0.5 % of output signal at 50/60 Hz

**Influence of frequency <sup>(2)</sup>:**

< 5 % of output signal from 20 Hz ... 1 kHz  
< 10 % of output signal from 1 kHz ... 10 kHz

**Influence of crest factor:**

< 3 % of output signal for crest factor < 5 with current < 40 Arms

### Mechanical specifications

**Operating temperature:**

-10 °C to +55 °C

**Storage temperature:**

-40 °C to +70 °C

**Influence of temperature:**

≤ 0.2 % of output signal per 10 °K

**Relative humidity for operation:**

0 to 85 % RH decreasing linearly above 35 °C

**Influence of relative humidity:**

< 0.2 % of output signal from 10 % to 85 % RH

**Operating altitude:**

0 to 2,000 m

**Max. jaw opening:**

20 mm

**Clamping capacity:**

Cable: Ø max 20 mm  
Busbar: 1 busbar of 20 x 5 mm

**Casing protection rating:**

IP40 (IEC 529)

**Drop test:**

1 m (IEC 68-2-32)

**Shock resistance:**

100 g (IEC 68-2-27)

**Vibration resistance:**

10/55/10 Hz, 0.15 mm (IEC 68-2-6)

**Self-extinguishing capability:**

Casing: UL94 V2  
Jaws: UL94 V0

**Dimensions:**

135 x 51 x 30 mm

**Weight:**

180 g

**Colours:**

Dark grey case with red jaws

**Output:**

1.5 m two-wire lead with double or reinforced insulation terminated by 2 elbowed male safety plugs (4 mm)

### Safety specifications:

**Electrical safety:**

Instrument with double insulation or reinforced insulation between the primary, the secondary and the grippable part located under the guard as per IEC 1010-1 & IEC 1010-2-032

- 600 V category III, pollution degree 2
- 300 V category IV, pollution degree 2

**Electromagnetic compatibility (EMC):**

- EN 50081-1: class B
- EN 50082-2:
  - Electrostatic discharge: IEC 1000-4-2
  - Radiated field: IEC 1000-4-3
  - Fast transients: IEC 1000-4-4
  - Magnetic field at 50 Hz: IEC 1000-4-8

(1) Conditions of reference: 23 °C ± 3 °K, 20 % to 75 % RH, sinusoidal signal with frequency of 48 Hz to 65 Hz, external magnetic field < 40 A/m, no DC components, no external conductor with circulating current, conductor centred for measurement, load impedance > 1 MΩ.

(2) Out of reference domain

To order	Reference
AC current clamp model MN71 with operating manual	P01120420

## Model MN73

Current	2 AAC	200 AAC
Output	1000 mV/A	10 mV/A

### Description

This clamp has a wide measurement range (up to 200 A), and it can also measure very low currents. We call it the "universal" probe.

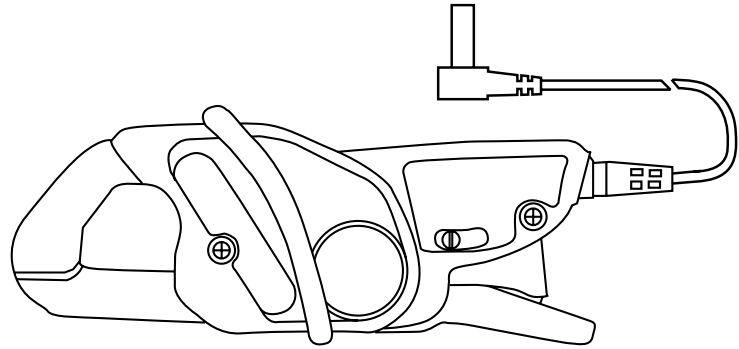

### Electrical specifications

#### Current calibres:

0.01 A AC...2.4 A AC  
0.1 A AC...240 A AC

#### Output signal:

1000 mVAC/A AC (2 V for 2 A)  
10 mVAC/A AC (2.4 V for 240 A)

#### Accuracy and phase shift <sup>(1)</sup>:

Calibre	2 A				200 A				
	0.01 A...0.1 A	0.1 A...1 A	1 A...2 A	2 A...2.4 A	0.1 A...1 A	1 A...20 A	20 A...80 A	80 A...150 A	150 A...200 A
Primary current									
% Accuracy of output signal	≤ 5 % + 2 mV	≤ 3 % + 1 mV	≤ 1 %	≤ 1 %	≤ 3 % + 200 μV	≤ 2 % + 200 μV	≤ 1 %	≤ 4 %	≤ 10 %
Phase shift	not specified				not specified	≤ 3°	≤ 2°	≤ 3°	≤ 4°

#### Bandwidth:

40 Hz...10 kHz

#### Crest factor:

5 for a current of 280 A peak (200 A rms)

#### Maximum currents:

200 A continuous for a frequency ≤ 1 kHz (limitation proportional to the inverse frequency beyond)

#### Load impedance:

> 1 MΩ

#### Operating voltage:

600 Vrms

#### Common mode voltage:

600 V category III and pollution degree 2

#### Influence of adjacent conductor:

≤ 15 mA/A at 50 Hz

#### Influence of conductor position in jaws:

≤ 0.5 % of output signal at 50/60 Hz

#### Influence of frequency <sup>(2)</sup>:

##### ■ 2 A calibre:

< 10 % of output signal from 40 Hz...10 kHz

##### ■ 200 A calibre:

< 5 % of output signal from 40 Hz...1 kHz\*\*

< 15 % of output signal from 1 kHz...10 kHz

\*\* add 10 % error if  $100 A < I_{\text{Primary}} < 200 A$

#### Influence of crest factor:

< 5 % of output signal for crest factor < 5 with current < 280 A rms

### Mechanical specifications

#### Operating temperature:

-10 °C to +55 °C

#### Storage temperature:

-40 °C to +70 °C

#### Influence of temperature:

≤ 0.20 % of output signal per 10 °K

#### Relative humidity for operation:

0 to 85 % RH decreasing linearly above 35 °C

#### Influence of relative humidity:

< 0.2 % of output signal from 10 % to 85 % RH

#### Operating altitude:

0 to 2,000 m

#### Max. jaw opening:

20 mm

#### Clamping capacity:

Cable: Ø max 20 mm

Busbar: 1 busbar of 20 x 5 mm

#### Casing protection rating:

IP40 (IEC 529)

#### Drop test: 1 m (IEC 68-2-32)

#### Shock resistance:

100 g (IEC 68-2-27)

#### Vibration resistance:

10/55/10 Hz, 0.15 mm (IEC 68-2-6)

#### Self-extinguishing capability:

Casing: UL94 V2

Jaws: UL94 V0

#### Dimensions:

135 x 51 x 30 mm

#### Weight:

180 g

#### Colours:

Dark grey case with red jaws

#### Output:

1.5 m two-wire lead with double or reinforced insulation terminated by 2 elbowed male safety plugs (4 mm)

### Safety specifications

#### Electrical safety:

Instrument with double insulation or reinforced insulation between the primary, the secondary and the grippable part located under the guard as per IEC 1010-1 & IEC 1010-2-032

- 600 V category III, pollution degree 2

- 300 V category IV, pollution degree 2

#### Electromagnetic compatibility (EMC):

EN 50081-1: class B

EN 50082-2:

- Electrostatic discharge: IEC 1000-4-2

- Radiated field: IEC 1000-4-3

- Fast transients: IEC 1000-4-4

- Magnetic field at 50 Hz: IEC 1000-4-8

(1) Conditions of reference: 23 °C ± 3 °K, 20 % to 75 % RH, sinusoidal signal with frequency of 48 Hz to 65 Hz, external magnetic field < 40 A/m, no DC components, no external conductor with circulating current, conductor centred for measurement, load impedance > 1 MΩ.

(2) Out of reference domain

To order	Reference
AC current clamp model MN73 with operating manual	P01120421
Accessory: <b>AN1</b> artificial neutral box (see chapter 12)	P01197201

# Current clamps for AC current

## Models MN88 and MN89

MN series

Current	200 A AC
Output	100 mV DC/A

### Description

These clamps produce a DC voltage output which is very useful for multimeters whose sensitivity in V or A is too weak.

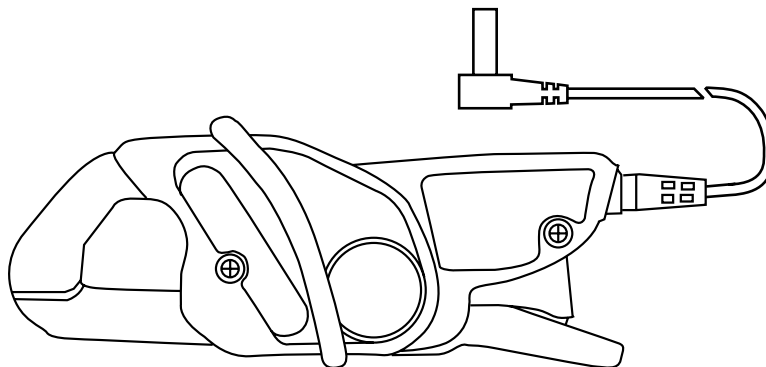

### Electrical specifications

#### Current calibre:

0.5 A AC ... 240 A AC

#### Output signal:

100 mV DC/A (24 V for 240 A AC)

#### Accuracy <sup>(1)</sup>:

Primary current	0.5 A...10 A	10 A...40 A	40 A...100 A	100 A...240 A
Accuracy in % of output signal	≤ 5 % + 50 mV	≤ 3 % + 50 mV	≤ 2 % + 50 mV	≤ 2 %

#### Bandwidth:

40 Hz ... 10 kHz

#### Crest factor:

3 for a current of 200 Arms

#### Maximum currents:

200 A continuous for a frequency ≤ 1 Hz (derating proportional to the inverse of frequency beyond)

#### Load impedance:

> (1 MΩ + filter RC 2 s)

#### Operating voltage:

600 V rms

#### Common mode voltage:

600 V category III and pollution degree 2

#### Influence of adjacent conductor:

≤ 15 mA / A at 50 Hz

#### Influence of conductor position in jaws:

≤ 0.5 % of output signal at 50 Hz

#### Influence of frequency <sup>(2)</sup>:

< 5 % of output signal from 40 Hz ... 1 kHz  
< 12 % of output signal from 1 kHz ... 10 kHz

#### Influence of crest factor

< 3 % of output signal for a crest factor of 3 and current of 200 A rms

### Mechanical specifications

#### Operating temperature:

-10 °C to +55 °C

#### Storage temperature:

-40 °C to +70 °C

#### Influence of temperature:

≤ 0.15 % of output signal per 10 °K

#### Relative humidity for operation:

0 to 85 % RH decreasing linearly above 35 °C

#### Influence of relative humidity:

< 0.2 % of output signal from 10 % to 85 % RH

#### Operating altitude:

0 to 2,000 m

#### Max. jaw opening:

20 mm

#### Clamping capacity:

Cable: Ø max 20 mm  
Busbar: 1 busbar of 20 x 5 mm

#### Casing protection rating:

IP40 (IEC 529)

#### Drop test: 1 m (IEC 68-2-32)

#### Shock resistance:

100 g (IEC 68-2-27)

#### Vibration resistance:

10/55/10 Hz, 0.15 mm (IEC 68-2-6)

#### Self-extinguishing capability:

Casing: UL94 V2  
Jaws: UL94 V0

#### Dimensions:

135 x 51 x 30 mm

#### Weight:

180 g

#### Colours:

Dark grey case with red jaws

#### Output:

##### ■ MN88:

Safety sockets (4 mm)

##### ■ MN89:

1.5 m two-wire lead with double or reinforced insulation terminated by 2 elbowed male safety plugs (4 mm)

### Safety specifications

#### Electrical safety:

Instrument with double insulation or reinforced insulation between the primary, the secondary and the grippable part located under the guard as per IEC 1010-1 & IEC 1010-2-032

- 600 V category III, pollution degree 2

- 300 V category IV, pollution degree 2

#### Electromagnetic compatibility (EMC):

EN 50081-1: class B

EN 50082-2:

- Electrostatic discharge: IEC 1000-4-2

- Radiated field: IEC 1000-4-3

- Fast transients: IEC 1000-4-4

- Magnetic field at 50/60 Hz: IEC 1000-4-8

(1) Conditions of reference: 23 °C ± 3 °K, 20 to 70 % RH, sinusoidal signal with frequency of 48 Hz to 65 Hz, external magnetic field < 40 A/m, no DC components, no external conductor with circulating current, conductor centred for measurement, load impedance > 1 MΩ + filter RC 2s.

(2) Out of reference domain

To order	Reference
AC current clamp model <b>MN88</b> with operating manual	P01120410
AC current clamp model <b>MN89</b> with operating manual	P01120415

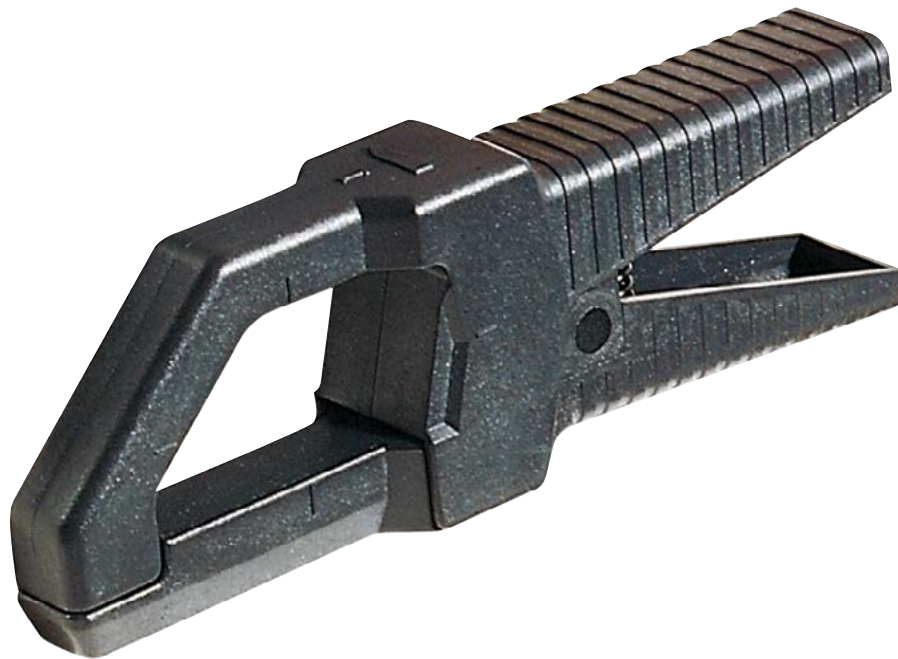

## Y series

The Y series clamps are designed to be both rugged and versatile whilst remaining easy to use. The jaws are designed so that the clamps can be hooked onto cables or clamped onto busbars for current measurement up to 600 A AC.

There are two types of Y series clamps available:

The first acts as a current transformer (ratios of 100:1 or 1000:1), giving an output current that may be read by a multimeter, logger or other suitable devices with appropriate current calibres.

The other kind of Y series clamp has a DC voltage output proportional to the AC current measured, allowing instruments without current calibres to measure, display and record currents on a DC voltage calibre.

There is also a model available specifically for direct use with oscilloscopes.

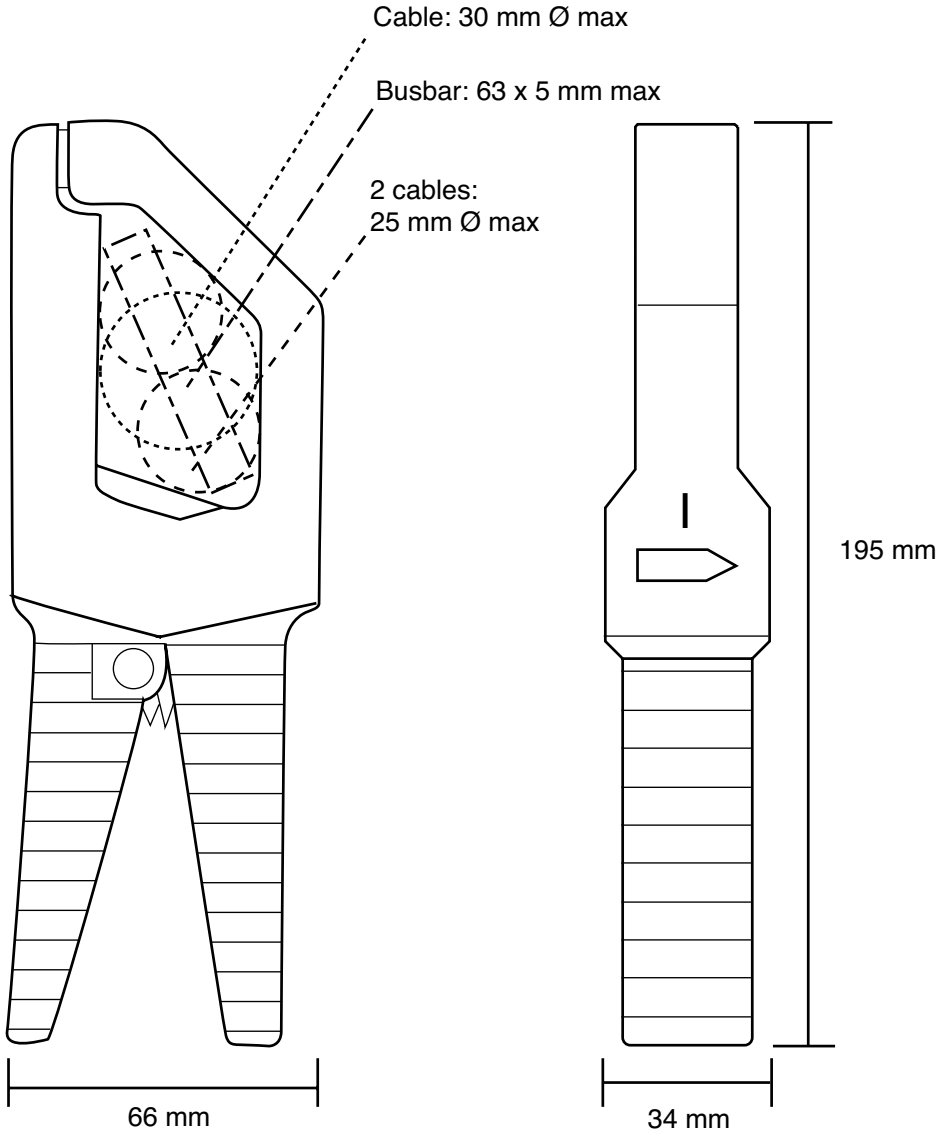

# Current clamp for AC current

## Model Y1N

Y<sub>N</sub> series

Current	600 A AC
Ratio	1000/1
Output	1 mA/A

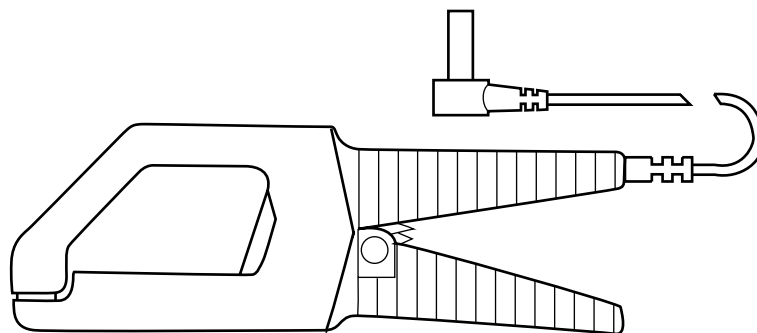

### Electrical specifications

**Current calibre:**  
4 A AC ... 600 A AC

**Current transformation ratio:**  
1000:1

**Output signal:**  
1 mA AC/A AC

**Accuracy <sup>(1)</sup>:**

Primary current	4 A	25 A	100 A	250 A	500 A	600 A <sup>(2)</sup>
Accuracy in % of output signal	4.5 % + 0.5 mA	4.5 %	3.5 %	3 %	3 %	3 %
Phase shift	not specified	4°	2°	2°	2°	2°

class 3 at 1.25 VA

### Bandwidth:

48 Hz ... 1000 Hz

### Load impedance:

5 Ω max

### Overload:

700 A for 10 minutes

### Maximum output voltage (secondary open):

Electronic protection circuit limiting voltage to 10 V peak max.

### Operating voltage:

600 V rms

### Common mode voltage:

600 V rms

### Influence of adjacent and parallel conductors:

< 30 mA/A at 50 Hz

### Influence of conductor position in jaws:

±1.5 %

### Mechanical specifications

#### Operating temperature:

-15 °C ... +50 °C

#### Storage temperature:

-40 °C ... +85 °C

#### Influence of temperature:

< 0.1 % per 10 °K

#### Operating altitude:

0 to 2,000 m

#### Max. jaw opening:

33 mm

#### Clamping capacity:

Cable: Ø max 30 mm

Busbar: 63 x 5 mm

#### Casing protection rating:

IP20 in accordance with IEC 529

#### Drop test:

1.5 m (IEC 68-2-32)

#### Shock resistance:

100 g, in accordance with IEC 68-2-27

#### Vibration resistance:

10/55/10 Hz, 0.15 mm test in accordance with IEC 68-2-6

#### Self-extinguishing capability:

UL94 V0

### Dimensions:

66 x 195 x 34 mm

### Weight:

420 g

### Colour:

Dark grey

### Output:

1.5 m two-wire lead with double or reinforced insulation terminated by 2 elbowed male safety plugs (4 mm)

### Safety specifications

#### Electrical safety:

Double or reinforced insulation between the primary and secondary circuits and the outer casing in accordance with IEC 1010-2-032.

- 600 V category III, pollution degree 2
- 300 V category IV, pollution degree 2

#### Electromagnetic compatibility (EMC):

EN 50081-1: class B

EN 50082-2:

- Electrical discharge: IEC 1000-4-2
- Radial field: IEC 1000-4-3
- Fast transients: IEC 1000-4-4
- Magnetic field at 50/60Hz: IEC 1000-4-8

(1) Conditions of reference: 23 °C ± 5 °K, 20 % to 75 % RH, 48 Hz to 65 Hz, external magnetic field < 40 A/m, no current-carrying conductor nearby, centred test sample, load impedance 5 Ω.

(2) 700 A for 10 minutes max

To order	Reference
AC current clamp model Y1N with operating manual	P01120001A



# Current clamp for AC current

## Model Y2N

Y<sub>N</sub> series

Current	600 A AC
Ratio	1000/1
Output	1 mA/A

### ■ Electrical specifications

**Current calibre:**  
4 A AC ... 600 A AC

**Current transformation ratio:**  
1000:1

**Output signal:**  
1 mA AC/A AC

**Accuracy <sup>(1)</sup>:**

Primary current	4 A	25 A	100 A	250 A	500 A	600 A <sup>(2)</sup>
Accuracy in % of output signal	3 % + 0.5 mA	3 %	1.5 %	1 %	1 %	1 %
Phase shift	not specified	3°	1.5°	1°	1°	1°

class 1 at 1.25 VA

### **Bandwidth:**

48 Hz ... 1000 Hz

### **Load impedance:**

5 Ω max

### **Overload:**

700 A for 10 minutes

### **Max. voltage at output (secondary circuit open):**

Electronic protection circuit limiting voltage to 10 V peak max.

### **Operating voltage:**

600 V rms

### **Common mode voltage:**

600 V rms

### **Influence of adjacent and parallel conductors:**

< 30 mA/A at 50 Hz

### **Influence of conductor position in jaws:**

< 1 %

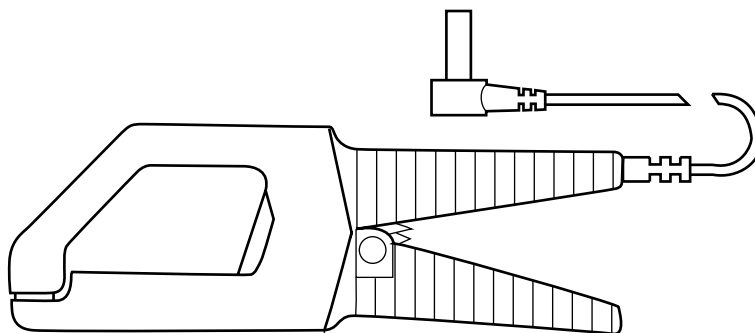

### ■ Mechanical specifications

#### **Operating temperature:**

-15 °C ... +50 °C

#### **Storage temperature:**

-40 °C ... +85 °C

#### **Influence of temperature:**

< 0.1 % per 10 °K

#### **Operating altitude:**

0 to 2,000 m

#### **Max. jaw opening:**

33 mm

#### **Clamping capacity:**

Cable: Ø max 30 mm

Busbar: 63 x 5 mm

#### **Casing protection rating:**

IP20 in accordance with IEC 529

#### **Drop test:**

1.5 m (IEC 68-2-32)

#### **Shock resistance:**

100 g, in accordance with IEC 68-2-27

#### **Vibration resistance:**

10/55/10 Hz, 0.15 mm test in accordance with IEC 68-2-6

#### **Self-extinguishing capability:**

UL94 V0

### **Dimensions:**

66 x 195 x 34 mm

### **Weight:**

420 g

### **Colour:**

Dark grey

### **Output:**

1.5 m two-wire lead with double or reinforced insulation terminated by 2 elbowed male safety plugs (4 mm)

### ■ Safety specifications

#### **Electrical safety:**

Double or reinforced insulation between the primary and secondary circuits and the outer casing in accordance with IEC 1010-2-032.

- 600 V category III, pollution degree 2
- 300 V category IV, pollution degree 2

#### **Electromagnetic compatibility (EMC):**

EN 50081-1: class B

EN 50082-2:

- Electrical discharge IEC 1000-4-2

- Radial field IEC 1000-4-3

- Fast transients IEC 1000-4-4

- Magnetic field at 50/60 Hz IEC 1000-4-8

(1) Conditions of reference: 23 °C ± 5 °K, 20 % to 75 % RH, 48 Hz to 65 Hz, external magnetic field < 40 A/m, no current-carrying conductor nearby, centred test sample, load impedance 5 Ω.

(2) 700 A for 10 minutes max

To order	Reference
AC current clamp model Y2N with operating manual	P01120028A

# Current clamp for AC current

## Model Y3N

Y<sub>N</sub> series

Current	600 A AC
Ratio	100/1
Output	10 mA/A

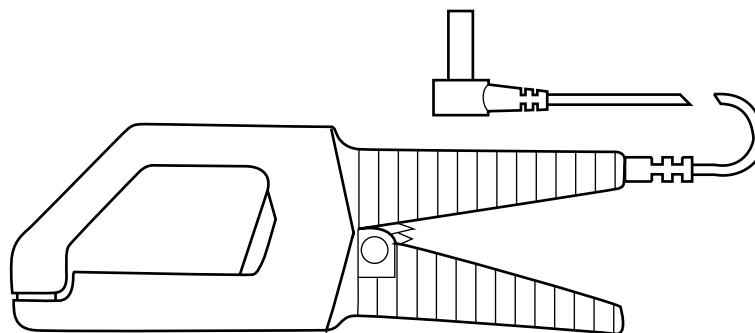

### Electrical specifications

**Current calibre:**  
4 A AC...600 A AC

**Current transformation ratio:**  
100:1

**Output signal:**  
10 mA AC/A AC

**Accuracy <sup>(1)</sup>:**

Primary current	4 A	25 A	100 A	250 A	500 A	600 A <sup>(2)</sup>
Accuracy in % of output signal	5 % + 5 mA	5 %	3 %	3 %	3 %	3 %
Phase shift	not specified	6°	5°	3°	3°	3°

Class 3 at 2.5 VA

**Bandwidth:**  
48 Hz ... 1000 Hz

**Load impedance:**  
0.1 Ω max

**Overload:**  
700 A for 10 minutes

**Max. voltage at output (secondary circuit open):**  
Electronic protection circuit limiting voltage to 10 V peak max.

**Operating voltage:**  
600 V rms

**Common mode voltage:**  
30 V rms

**Influence of adjacent and parallel conductors:**  
< 30 mA/A at 50 Hz

**Influence of conductor position in jaws:**  
±1 %

### Mechanical specifications

**Operating temperature:**  
-15 °C ... +50 °C

**Storage temperature:**  
-40 °C ... +85 °C

**Influence of temperature:**  
< 0.1 % per 10 °K

**Operating altitude:**  
0 to 2,000 m

**Max. jaw opening:**  
33 mm

**Clamping capacity:**  
Cable: Ø max 30 mm  
Busbar: 63 x 5 mm

**Casing protection rating:**  
IP20 in accordance with IEC 529

**Drop test:**  
1.5 m (IEC 68-2-32)

**Shock resistance:**  
100 g, in accordance with IEC 68-2-27

**Vibration resistance:**  
10/55/10 Hz, 0.15 mm test in accordance with IEC 68-2-6

**Self-extinguishing capability:**  
UL94 V0

**Dimensions:**  
66 x 195 x 34 mm

**Weight:**  
420 g

**Colour:**  
Dark grey

**Output:**  
1.5 m two-wire lead with double or reinforced insulation terminated by 2 elbowed male safety plugs (4 mm)

### Safety specifications

#### Electrical safety:

Double or reinforced insulation between the primary and secondary circuits and the outer casing in accordance with IEC 1010-2-032.  
- 600 V category III, pollution degree 2  
- 300 V category IV, pollution degree 2

#### Electromagnetic compatibility (EMC):

EN 50081-1: class B  
EN 50082-2:  
- Electrical discharge IEC 1000-4-2  
- Radial field IEC 1000-4-3  
- Fast transients IEC 1000-4-4  
- Magnetic field at 50/60 Hz IEC 1000-4-8

(1) Conditions of reference: 23 °C ± 5 °K, 20 % to 75 % RH, 48 Hz to 65 Hz, external magnetic field < 40 A/m, no current-carrying conductor nearby, centred test sample, load impedance 0.1 Ω.

(2) 700 A for 10 minutes max.

To order	Reference
AC current clamp model Y3N with operating manual	P01120029A

# Current clamp for AC current

## Model Y4N

Y<sub>N</sub> series

Current	600 A AC
Output	1 mV DC/AAC

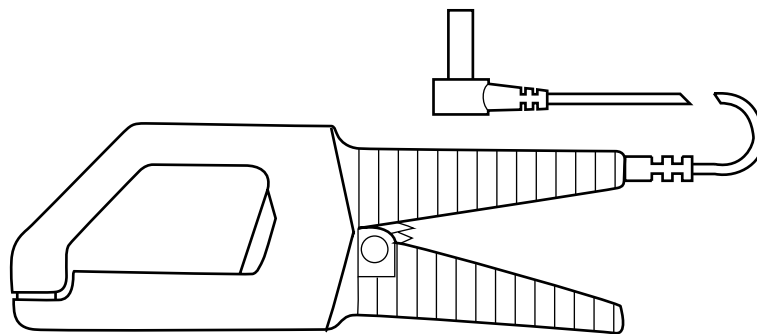

### Electrical specifications

**Current calibre:**  
4 A AC ... 600 A AC

**Output signal:**  
1 mV DC/AAC

**Accuracy <sup>(1)</sup>:**

Primary current	2 A	25 A	100 A	250 A	500 A	600 A <sup>(2)</sup>
Accuracy in % of output signal	5 % + 0.5 mV DC	5 %	2 %	1 %	1 %	2 %

**Bandwidth:**  
48 Hz ... 1000 Hz  
(error: add 2 % to reference)

**Load impedance:**  
> 100 kΩ max

**Overload:**  
700 A for 10 minutes

**Operating voltage:**  
600 V rms

**Common mode voltage:**  
600 V rms

**Influence of adjacent and parallel conductors:**  
< 30 mA/A at 50 Hz

**Influence of conductor position in jaws:**  
±1 %

**Drop test:**  
1.5 m (IEC 68-2-32)

**Shock resistance:**  
100 g, in accordance with IEC 68-2-27

**Vibration resistance:**  
10/55/10 Hz, 0.15 mm test in accordance with IEC 68-2-6

**Self-extinguishing capability:**  
UL94 V0

**Dimensions:**  
66 x 195 x 34 mm

**Weight:**  
420 g

**Colour:**  
Dark grey

**Output:**  
1.5 m two-wire lead with double or reinforced insulation terminated by 2 elbowed male safety plugs (4 mm)

### Mechanical specifications

**Operating temperature:**  
-15 °C ... +50 °C

**Storage temperature:**  
-40 °C ... +85 °C

**Influence of temperature:**  
< 0.1 % per 10 °K

**Operating altitude:**  
0 to 2,000 m

**Max. jaw opening:**  
33 mm

**Clamping capacity:**  
Cable: Ø max 30 mm  
Busbar: 63 x 5 mm

**Casing protection rating:**  
IP20 in accordance with IEC 529

### Safety specifications

**Electrical safety:**  
Double or reinforced insulation between the primary and secondary circuits and the outer casing in accordance with IEC 1010-2-032.  
- 600 V category III, pollution degree 2  
- 300 V category IV, pollution degree 2

**Electromagnetic compatibility (EMC):**  
EN 50081-1: class B  
EN 50082-2:  
- Electrical discharge: IEC 1000-4-2  
- Radial field: IEC 1000-4-3  
- Fast transients: IEC 1000-4-4  
- Magnetic field at 50/60 Hz: IEC 1000-4-8

(1) Conditions of reference: 23 °C ± 5 °K, 20 % to 75 % RH, 48 Hz to 65 Hz, external magnetic field < 40 A/m, no current-carrying conductor nearby, centred test sample, load impedance 10 MΩ.

(2) 600 A for 10 minutes max

To order	Reference
AC current clamp model Y4N with operating manual	P01120005A

## Model Y7N (insulated AC current probe)

Current	1200 A peak
Output	1 mV/A

### Description

This 500 A AC clamp can be used for the display and measurement of 'current' curves. It comes with a coaxial cable terminated by a BNC plug, thus making it the ideal tool for use with oscilloscopes. It supplies a mV output signal that is directly proportional to the measured current.

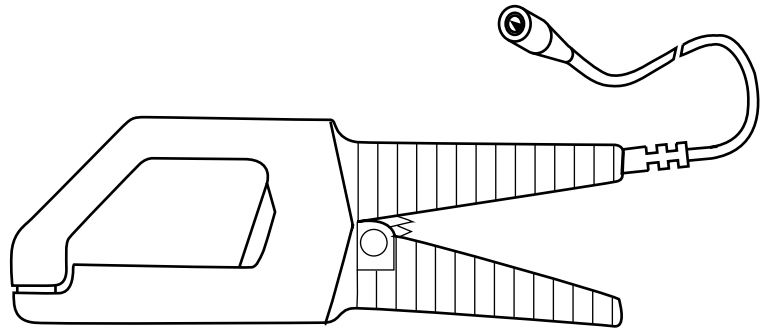

### Electrical specifications

#### Current calibre:

1 A AC ... 500 A AC (1200 A peak)

#### Output signal:

1 mVAC/A AC (0.5 V for 500 A)

#### Accuracy and phase shift <sup>(1)</sup>:

Primary current	1 A...20 A	20 A...100 A	100 A...500 A
Accuracy in % of output signal	≤ 5 % + 0.3 mV	≤ 5 %	≤ 2 %
Phase shift	not specified	≤ 3°	≤ 1°

#### Bandwidth:

5 Hz ... 10 kHz (to -3 dB) (depending on current)

#### Rise/fall time from 10 % to 90 %:

37 μs

#### 10 % delay time:

1 μs

#### Ampere second product:

10 A.s

#### Insertion impedance (at 400 Hz / 10 kHz):

< 0.1 mΩ / < 3.1 mΩ

#### dV/dt:

0.24 mV/μs (typical)

#### Maximum currents:

500 A constant

700 A: 10 minutes operation / 30 minutes shutdown for frequency ≤ 2 kHz (limitation proportional to the inverse of one third of the frequency above that)

#### Load impedance interne:

≤ 100 Ω / 4.7 nF

#### Influence of temperature:

≤ 0.15 % of output signal per 10 °K

#### Influence of adjacent conductor:

≤ 5 μV / A at 50 Hz

#### Influence of conductor position in jaws:

≤ 1.5 % + 0.1 AAC

### Mechanical specifications

#### Operating temperature:

-25 °C to +50 °C

#### Storage temperature:

-40 °C to +80 °C

#### Relative humidity for operation:

0 to 85 % RH decreasing linearly above 35 °C

#### Operating altitude:

0 to 2,000 m

#### Max. jaw opening:

33 mm

#### Clamping capacity:

Cable: Ø max 30 mm  
Busbar: 1 busbar of 63 x 5 mm

#### Casing protection rating:

IP20 (IEC 529)

#### Drop test:

1.5 m (IEC 68-2-32)

#### Shock resistance:

100 g / 6 ms / half-period (IEC 68-2-27)

#### Protection against impacts:

IK04 0.5 J (EN 50102)

#### Vibration resistance:

10/55/10 Hz 0.15 mm (IEC 68-2-6)

#### Self-extinguishing capability:

UL94 V0

#### Dimensions:

195 x 66 x 34 mm

#### Weight:

420 g

#### Colour:

Dark grey

#### Output:

Via 2 m coaxial cable terminated by insulated BNC plug

### Safety specifications

#### Electrical safety:

Instrument with double insulation or reinforced insulation between the primary, the secondary and the grippable part located under the guard as per IEC 1010-1 & IEC 1010-2-032

- 600 V category III, pollution degree 2
- 300 V category IV, pollution degree 2

#### Electromagnetic compatibility (EMC):

EN 50081-1: class B

EN 50082-2:

- Electrostatic discharge: IEC 1000-4-2  
4 kV level 2 performance criterion B  
8 kV in the air level 3 performance criterion B
- Radiated field: IEC 1000-4-3  
10 V/m performance criterion A
- Fast transients: IEC 1000-4-4  
1 kV level 2 performance criterion B  
2 kV level 3 performance criterion B
- Magnetic field at 50/60 Hz: IEC 1000-4-8  
field of 400 A/m at 50 Hz: < 1 A

# Oscilloscope clamp for AC current

## Model Y7N (insulated AC current probe)

### Curves

Error on measurement at 50 Hz

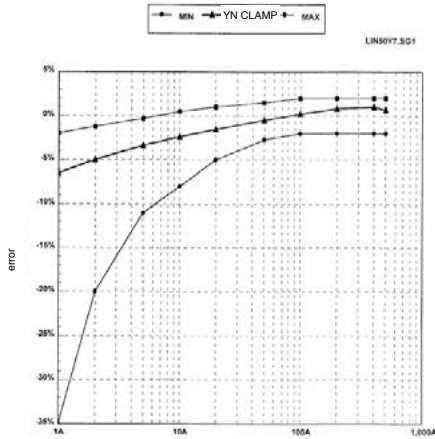

Phase shift at 50 Hz

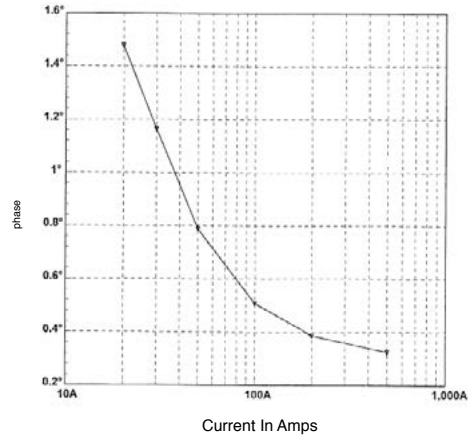

Frequency response

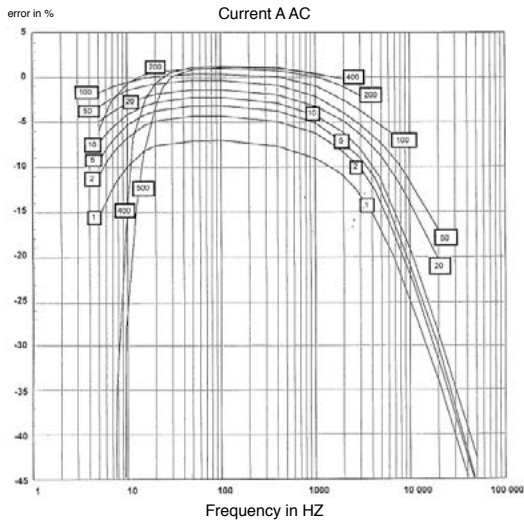

Phase shift according to frequency

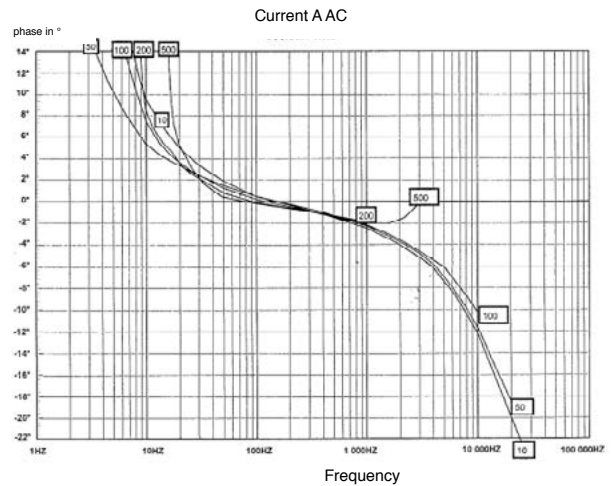

Influence of frequency and derating

Frequency Hz	5 Hz to 10 Hz	10 Hz to 20 Hz	20 Hz to 45 Hz	65 Hz to 3 kHz	3 kHz to 6 kHz	6 kHz to 10 kHz
1 A to 200 A	15 %					
> 200 A	not spec.					
1 A to 300 A		5 %				
300 A to 400 A		15 %				
400 A to 500 A		25 %				
1 A to 500 A			5 %			
1 A to 50 A				5 % + 0.4 A		
50 A to 500 A				5 %		
> 500 A				not spec.		
1 A to 100 A					15 % + 0.4 A	
> 100 A					not spec.	
1 A to 50 A						-3 dB
> 50 A						not spec.

- Error in % of reading; not spec. means not specified  
 - Do not exceed 500 A for measurement with constant operation, and for the derating, use the formula  $500(A) \cdot 2 / F(\text{kHz})$  to calculate the maximum current in A AC, in constant use, depending on the frequency in kHz.

Influence of DC current

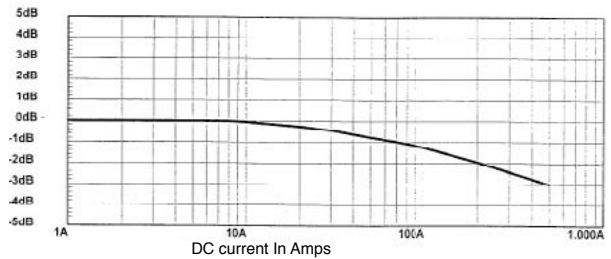

# Oscilloscope clamp for AC current

## Model Y7N (insulated AC current probe)

### ■ Response to a square signal

5 A at 10 Hz

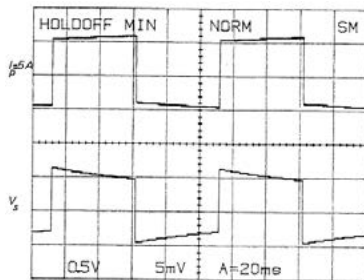

5 A at 50 Hz

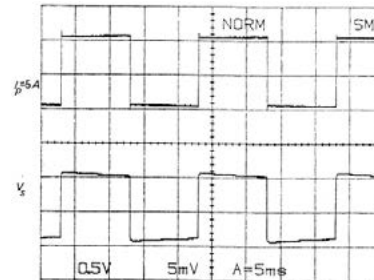

5 A at 500 Hz

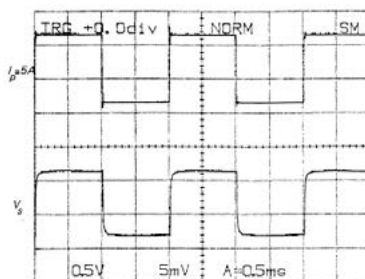

5 A at 4 kHz

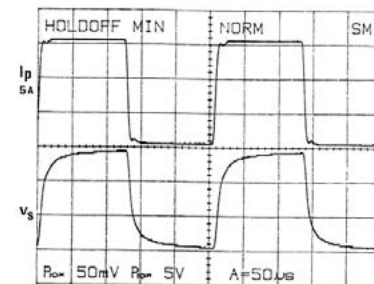

### ■ Response to a step

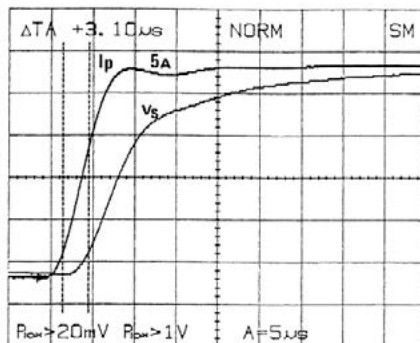

(1) Conditions of reference: 23 °C ± 3 °K, 20 % to 75 % RH, sinusoidal signal with frequency of 48 Hz at 1 kHz, external magnetic field < 40 A/m, no DC components, no external conductor with circulating current, conductor centred for measurement, load impedance >1 MΩ / < 100 pF.

To order	Reference
AC current clamp model Y7N for oscilloscope with operating manual	P01120075



## "C100" series

The "C100" series is a range of thirteen transformer clamps with all the advantages of our old "C30" series clamps whilst incorporating considerable improvements, particularly in the field of safety, ergonomics and performance:

- 1000 A measurement, excellent metrology, high accuracy, high level of linearity, symmetrical coil windings for minimum phase shift, pendular adjusting system for magnetic elements, maximum conductor diameter  $\varnothing$  52 mm and also some models with  $\mu$  metal core specially made for wattmeter use.
- Innovative design: excellent ergonomics, handle with finger grips, assisted opening system for jaws (patented system).

- IEC 1010 600 V cat. III safety (industry and services), anti-slip protection, conductor anti-pinching system,...

All this technology and manufacturing quality has been combined to provide the best measurement possible without any complications.

A "C100" series clamp is compatible with any instrument (multimeter, wattmeter, recorder, oscilloscope...) for safe measurement of AC currents without shutting down the installation.

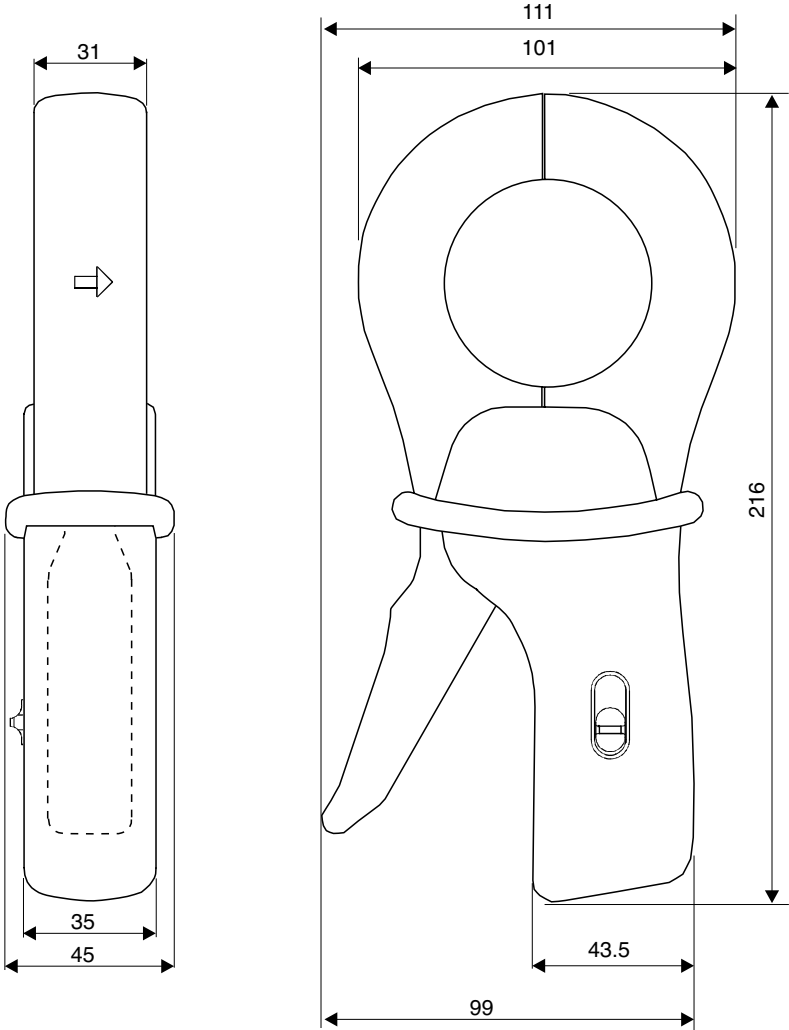



# Current clamp for AC current

## Model C100

C100 series

Current	1000 A
Ratio	1000/1
Output	1 mA/A

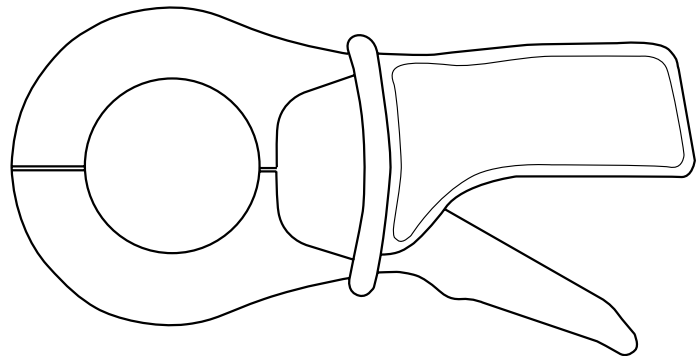

### Electrical specifications

#### Current calibre:

0.1 A AC ... 1200 A AC

#### Current transformation ratio:

1000:1

#### Output signal:

1 mA AC/A AC (1 A to 1000 A)

#### Accuracy and phase shift <sup>(1)</sup>:

Primary current	0.1 A...10 A	10 A	50 A <sup>(2)</sup>	200 A <sup>(2)</sup>	1000 A <sup>(2)</sup>	1200 A <sup>(2)</sup>
Accuracy in % of output signal	≤ 3 % + 0.1 mA	≤ 3 %	≤ 1.5 %	≤ 0.75 %	≤ 0.5 %	≤ 0.5 %
Phase shift	not specified	≤ 3°	≤ 1.5°	≤ 0.75°	≤ 0.5°	≤ 0.5°

#### Bandwidth:

30 Hz ... 10 kHz (-3 dB)

#### Crest factor:

≤ 6 for a current ≤ 3000 A peak (500 Arms)

#### Maximum currents:

1000 A continuous for a frequency ≤ 1 kHz (limitation proportional to the inverse frequency beyond)

1200 A for 40 minutes max. (interval between measurements > 20 minutes)

#### Load impedance:

≤ 15 Ω

#### Operating voltage:

600 V rms

#### Common mode voltage:

600 V category III and pollution degree 2

#### Influence of adjacent conductor:

≤ 1 mA/A at 50 Hz

#### Influence of conductor position in jaws:

≤ 0.1 % of output signal for frequencies ≤ 400 Hz

#### Load influence:

from 5 Ω to 15 Ω

< 0.5 % on measurement

< 0.5° on phase

#### Influence of frequency <sup>(3)</sup>:

< 1 % of output signal from 30 Hz ... 48 Hz

< 0.5 % of output signal from 65 Hz ... 1 kHz

< 1 % of output signal from 1 kHz ... 5 kHz

#### Influence of crest factor:

< 1 % of output signal for crest factor ≤ 6 with current ≤ 3000 A peak (500 Arms)

#### Influence of DC current superimposed on rated current:

< 1 % of output signal for a current ≤ 30 A DC

### Mechanical specifications

#### Operating temperature:

-10 °C to +50 °C

#### Storage temperature:

-40 °C to +70 °C

#### Influence of temperature:

≤ 0.1 % of output signal per 10 °K

#### Relative humidity for operation:

0 to 85 % RH decreasing linearly above 35 °C

#### Influence of relative humidity:

< 0.1 % of output signal from 10 % to 85 % RH

#### Operating altitude:

0 to 2,000 m

#### Max. jaw opening:

53 mm

Patented progressive opening system

#### Clamping capacity:

Cable: Ø max 52 mm

Busbar: 1 busbar of 50 x 5 mm / 4 busbars of 30 x 5 mm

#### Casing protection rating:

IP40 (IEC 529)

#### Drop test:

1 m (IEC 68-2-32)

#### Shock resistance:

100 g (IEC 68-2-27)

#### Vibration resistance:

5/15 Hz 1.5 mm

15/25 Hz 1 mm

25/55 Hz 0.25 mm

(IEC 68-2-6)

#### Self-extinguishing capability:

Casing and jaws: UL94 V0

#### Dimensions:

216 x 111 x 45 mm

#### Weight:

550 g

#### Colours:

Dark grey case with red jaws

#### Output:

Safety sockets (4 mm)

### Safety specifications

#### Electrical safety:

Instrument with double insulation or reinforced insulation between the primary, the secondary and the grippable part located under the guard as per IEC 1010-1 & IEC 1010-2-032

- 600 V category III, pollution degree 2

- 300 V category IV, pollution degree 2

#### Electromagnetic compatibility (EMC):

EN 50081-1: class B

EN 50082-2:

- Electrostatic discharge: IEC 1000-4-2

- Radiated field: IEC 1000-4-3

- Fast transients: IEC 1000-4-4

- Magnetic field at 50/60 Hz: IEC 1000-4-8

(1) Conditions of reference: 23 °C ± 3 °K, 20 % to 75 % RH, sine signal, frequency of 48 Hz to 65 Hz, distortion factor < 1 %, no DC components, external magnetic field < 40 A/m, no AC magnetic field, conductor centred for measurement, load impedance 5 Ω (5 VA)

(2) Accuracy class in accordance with IEC 185: 5 VA - class 0.5 - 48 Hz ... 65 Hz

(3) Out of frequency domain

To order	Reference
AC current clamp model C100 with operating manual	P01120301

# Current clamps for AC current

## Models C102 and C103

C100 series

Current	1000 A
Ratio	1000/1
Output	1 mA/A

### Description

An electronic voltage limiter protects the output of the clamp, if the secondary circuit is opened accidentally.

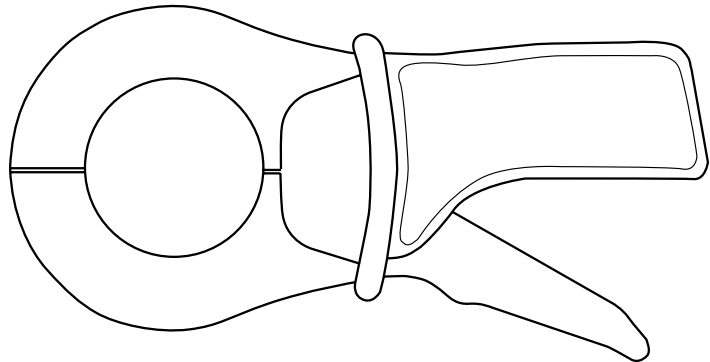

### Electrical specifications

#### Current calibre:

0.1 A AC ... 1200 A AC

#### Current transformation ratio:

1000:1

#### Output signal:

1 mA AC/A AC (1 A for 1000 A)

#### Accuracy and phase shift <sup>(1)</sup>:

Primary current	0.1 A...10 A	10 A	50 A <sup>(2)</sup>	200 A <sup>(2)</sup>	1000 A <sup>(2)</sup>	1200 A <sup>(2)</sup>
Accuracy in % of output signal	≤ 3 % + 0.1 mA	≤ 3 %	≤ 1.5 %	≤ 0.75 %	≤ 0.5 %	≤ 0.5 %
Phase shift	not specified	≤ 3°	≤ 1.5°	≤ 0.75°	≤ 0.5°	≤ 0.5°

#### Bandwidth:

30 Hz ... 10 kHz (-3 dB)

#### Crest factor:

≤ 6 for a current ≤ 3000 A peak (500 Arms)

#### Maximum currents:

1000 A continuous for a frequency ≤ 1 kHz (limitation proportional to the inverse frequency beyond)

1200 A for 40 minutes max. (interval between measurements > 20 minutes)

#### Load impedance:

≤ 15 Ω

#### Max. voltage output:

Electronic limiter 30 V max. peak

#### Operating voltage:

600 V rms

#### Common mode voltage:

600 V category III and pollution degree 2

#### Influence of adjacent conductor:

≤ 1 mA/A at 50 Hz

#### Influence of conductor position in jaws:

≤ 0.1 % of output signal for frequencies ≤ 400 Hz

#### Load influence:

from 5 Ω to 15 Ω

< 0.5 % on measurement

< 0.5° on phase

#### Influence of frequency <sup>(3)</sup>:

< 1 % of output signal from 30 Hz ... 48 Hz

< 0.5 % of output signal from 65 Hz ... 1 kHz

< 1 % of output signal from 1 kHz ... 5 kHz

#### Influence of crest factor:

< 1 % of output signal for crest factor ≤ 6 with current ≤ 3000 A peak (500 A rms)

#### Influence of DC current superimposed on rated current:

< 1 % of output signal for a current ≤ 30 A DC

### Mechanical specifications

#### Operating temperature:

-10 °C to +50 °C

#### Storage temperature:

-40 °C to +70 °C

#### Influence of temperature:

≤ 0.1 % of output signal per 10 °K

#### Relative humidity for operation:

0 to 85 % RH with a linear decrease above 35 °C

#### Influence of relative humidity:

< 0.1 % of output signal from 10 % to 85 % RH

#### Operating altitude:

0 to 2,000 m

#### Max. jaw opening:

53 mm, patented progressive opening system

#### Clamping capacity:

Cable: Ø max 52 mm

Busbar: 1 busbar of 50 x 5 mm / 4 busbars of 30 x 5 mm

#### Casing protection rating:

IP40 (IEC 529)

#### Drop test:

1 m (IEC 68-2-32)

#### Shock resistance:

100 g (IEC 68-2-27)

#### Vibration resistance:

5/15 Hz 1.5 mm - 15/25 Hz 1 mm - 25/55 Hz 0.25 mm (IEC 68-2-6)

#### Self-extinguishing capability:

Casing and jaws: UL94 V0

#### Dimensions:

216 x 111 x 45 mm

#### Weight:

550 g

#### Colours:

Dark grey case with red jaws

#### Output:

■ C102: safety sockets (4 mm)

■ C103: two-wire cable with reinforced insulation or double insulation, length 1.5 m, terminated by 2 insulated elbowed male banana plugs, Ø 4 mm

### Safety specifications

#### Electrical safety:

Instrument with double insulation or reinforced insulation between the primary, the secondary and the grippable part located under the guard as per IEC 1010-1 & IEC 1010-2-032

- 600 V category III, pollution degree 2

- 300 V category IV, pollution degree 2

#### Electromagnetic compatibility (EMC):

EN 50081-1: class B

EN 50082-2:

- Electrostatic discharge: IEC 1000-4-2

- Radiated field: IEC 1000-4-3

- Fast transients: IEC 1000-4-4

- Magnetic field at 50/60 Hz: IEC 1000-4-8

(1) Conditions of reference: 23 °C ± 3 °K, 20 % to 75 % RH, sine signal, frequency of 48 Hz to 65 Hz, distortion factor < 1 %, no DC components, external magnetic field < 40 A/m, no AC magnetic field, conductor centred for measurement, load impedance 5 Ω (5 VA).

(2) Accuracy class in accordance with IEC 185: 5 VA - class 0.5 - 48 ... 65 Hz.

(3) Out of reference domain.

To order	Reference
AC current clamp model <b>C102</b> with operating manual	P01120302
AC current clamp model <b>C103</b> with operating manual	P01120303

# Current clamps for AC current

## Models C106 and C107

C100 series

Current	1000 A
Output	1 mV/A

### Electrical specifications

#### Current calibre:

0.1 A AC...1200 A AC

#### Output signal:

1 mVAC/A AC (1 V for 1000 A)

#### Accuracy and phase shift <sup>(1)</sup>:

Primary current	0.1 A...10 A	10 A	50 A	200 A	1000 A	1200 A
% Accuracy of output signal	≤ 3 % + 0.1 mV	≤ 3 %	≤ 1.5 %	≤ 0.75 %	≤ 0.5 %	≤ 0.5 %
Phase shift	not specified	≤ 3°	≤ 1.5°	≤ 0.75°	≤ 0.5°	≤ 0.5°

#### Bandwidth:

30 Hz ...10 kHz

#### Crest factor:

≤ 6 for a current ≤ 3000 A peak (500 Arms)

#### Maximum currents:

1000 A continuous for a frequency ≤ 1 kHz (limitation proportional to the inverse frequency beyond)

1200 A for 40 minutes max. (interval between measurements > 20 minutes)

#### Output impedance:

1 Ω ± 1 %

#### Load impedance:

≥ 1 MΩ and ≤ 100 pF

#### Operating voltage:

600 V rms

#### Common mode voltage:

600 V category III and pollution degree 2

#### Influence of adjacent conductor:

≤ 1 μV/A at 50 Hz

#### Influence of conductor position in jaws:

≤ 0.1 % of output signal for frequencies ≤ 400 Hz

#### Load influence:

On receiver, for an input impedance of 100 Ω: ≤ 1 % on measurement, no measurement on phase.

On receiver, for an input impedance of 1 kΩ: ≤ 0.1 % on measurement, no measurement on phase

#### Influence of frequency <sup>(2)</sup>:

< 1 % of output signal from 30 Hz ...48 Hz

< 0.5 % of output signal from 65 Hz ...1 kHz

< 1 % of output signal from 1 kHz ...5 kHz

#### Influence of crest factor:

< 1 % of output signal for crest factor ≤ 6 with current ≤ 3000 A peak (500 Arms)

#### Influence of DC current superimposed on rated current:

< 1 % of output signal for a current ≤ 30 A DC

### Mechanical specifications

#### Operating temperature:

-10 °C to +50 °C

#### Storage temperature:

-40 °C to +70 °C

#### Influence of temperature:

≤ 0.1 % of output signal per 10 °K

#### Relative humidity for operation:

0 to 85 % RH decreasing linearly above 35 °C

#### Influence of relative humidity:

< 0.1 % of output signal from 10 % to 85 % RH

#### Operating altitude:

0 to 2,000 m

#### Max. jaw opening:

53 mm

Patented progressive opening system

#### Clamping capacity:

Cable: Ø max 52 mm

Busbar: 1 busbar of 50 x 5 mm / 4 busbars of 30 x 5 mm

#### Casing protection rating:

IP40 (IEC 529)

#### Drop test:

1 m (IEC 68-2-32)

#### Shock resistance:

100 g (IEC 68-2-27)

#### Vibration resistance:

5/15 Hz 1.5 mm

15/25 Hz 1 mm

25/55 Hz 0.25 mm

(IEC 68-2-6)

#### Self-extinguishing capability:

Casing and jaws: UL94 V0

#### Dimensions:

216 x 111 x 45 mm

#### Weight:

550 g

#### Colours:

Dark grey case with red jaws

#### Output:

■ C106: safety sockets (4 mm)

■ C107: two-wire cable with reinforced insulation or double insulation, length 1.5 m, terminated by 2 insulated elbowed male banana plugs, Ø 4 mm

### Safety specifications

#### Electrical safety:

Instrument with double insulation or reinforced insulation between the primary, the secondary and the grippable part located under the guard as per IEC 1010-1 & IEC 1010-2-032

- 600 V category III, pollution degree 2

- 300 V category IV, pollution degree 2

#### Electromagnetic compatibility (EMC):

EN 50081-1: class B

EN 50082-2:

- Electrostatic discharge: IEC 1000-4-2

- Radiated field: IEC 1000-4-3

- Fast transients: IEC 1000-4-4

- Magnetic field at 50/60 Hz: IEC 1000-4-8

(1) Conditions of reference: 23 °C ± 3 °K, 20 % to 75 % RH, sine signal, frequency of 48 Hz to 65 Hz, distortion factor < 1 %, no DC components, external magnetic field < 40 A/m, no AC magnetic field, conductor centred for measurement.

(2) Out of reference domain.

To order	Reference
AC current clamp model <b>C106</b> with operating manual	P01120304
AC current clamp model <b>C107</b> with operating manual	P01120305

# Current clamps for AC current

## Models C112 and C113

C100 series

Current	1000 A
Ratio	1000/1
Output	1 mA/A

### Description

Thanks to their excellent technical performance (phase shift and linearity), these  $\mu$ -metal core clamps are highly recommended for wattmeter use.  
These clamps are protected at output against overvoltages.

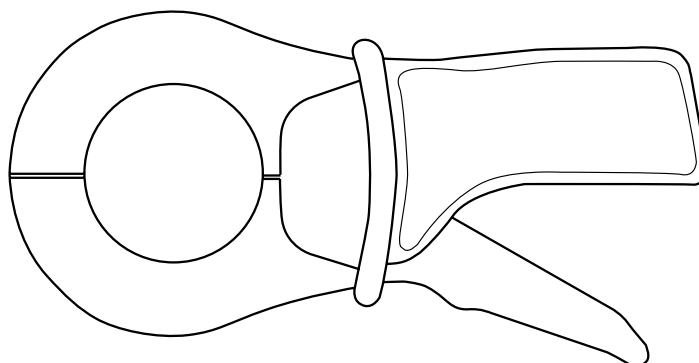

### Electrical specifications

#### Current calibre:

0.001 A AC ... 1200 A AC

#### Current transformation ratio:

1000:1

#### Output signal:

1 mA AC/A AC (1 A for 1000 A)

#### Accuracy and phase shift<sup>(1)</sup>:

Primary current	0.1 A...100 mA	0.1 A...1 A	1 A...10 A	10 A...100 A	100 A...1200 A
% Accuracy of output signal	$\leq 3\% + 5 \mu\text{A}$	$\leq 2\% + 3 \mu\text{A}$	$\leq 1\%$	$\leq 0.5\%$	$\leq 0.3\%$
Phase shift	not specified	not specified	$\leq 2^\circ$	$\leq 1^\circ$	$\leq 0.7^\circ$

#### Bandwidth:

30 Hz ... 10 kHz

#### Crest factor:

$\leq 6$  for a current  $\leq 2000$  A peak (300 Arms)

#### Maximum currents:

1000 A continuous for a frequency  $\leq 1$  kHz (limitation proportional to the inverse frequency beyond)

1200 A for 40 minutes max. (interval between measurements > 20 minutes)

#### Load impedance:

$\leq 1 \Omega$

#### Max. voltage output:

Electronic limiter 30 V max. peak

#### Operating voltage:

600 V rms

#### Common mode voltage:

600 V category III and pollution degree 2

#### Influence of adjacent conductor:

$\leq 0.5$  mA/A at 50 Hz

#### Influence of conductor position in jaws:

$\leq 0.1\%$  of output signal for frequencies  $\leq 400$  Hz

#### Load influence:

from  $1 \Omega$  to  $5 \Omega$   
 $< 0.1\%$  on measurement  
 $< 0.2^\circ$  on phase

#### Influence of frequency<sup>(2)</sup>:

$< 0.5\%$  of output signal from 30 Hz ... 48 Hz  
 $< 1\%$  of output signal from 65 Hz ... 1 kHz  
 $< 2\%$  of output signal from 1 kHz ... 5 kHz

#### Influence of crest factor:

$< 1\%$  of output signal for crest factor  $\leq 6$  with current  $\leq 2000$  A peak (300 A rms)

#### Influence of DC current superimposed on rated current:

$< 1\%$  of output signal for a current  $\leq 15$  A DC

### Mechanical specifications

#### Operating temperature:

$-10^\circ\text{C}$  to  $+50^\circ\text{C}$

#### Storage temperature:

$-40^\circ\text{C}$  to  $+70^\circ\text{C}$

#### Influence of temperature:

$\leq 0.2\%$  of output signal per  $10^\circ\text{K}$

#### Relative humidity for operation:

0 to 85 % RH with a linear decrease above  $35^\circ\text{C}$

#### Influence of relative humidity:

$< 0.1\%$  of output signal from 10 % to 85 % RH

#### Operating altitude:

0 to 2,000 m

#### Max. jaw opening:

53 mm, patented progressive opening system

#### Clamping capacity:

Cable:  $\varnothing$  max 52 mm  
Busbar: 1 busbar of 50 x 5 mm / 4 busbars of 30 x 5 mm

#### Casing protection rating:

IP40 (IEC 529)

#### Drop test:

1 m (IEC 68-2-32)

#### Shock resistance:

100 g (IEC 68-2-27)

#### Vibration resistance:

5/15 Hz 1.5 mm, 15/25 Hz 1 mm, 25/55 Hz 0.25 mm (IEC 68-2-6)

#### Self-extinguishing capability:

Casing and jaws: UL94 V0

#### Dimensions:

216 x 111 x 45 mm

#### Weight:

550 g

#### Colours:

Dark grey case with red jaws

#### Output:

■ C112: safety sockets (4 mm)  
■ C113: two-wire cable with reinforced insulation or double insulation, length 1.5 m, terminated by 2 insulated elbowed male banana plugs,  $\varnothing$  4 mm

### Safety specifications

#### Electrical safety:

Instrument with double insulation or reinforced insulation between the primary, the secondary and the grippable part located under the guard as per IEC 1010-1 & IEC 1010-2-032  
- 600 V category III, pollution degree 2  
- 300 V category IV, pollution degree 2

#### Electromagnetic compatibility (EMC):

EN 50081-1: class B  
EN 50082-2:  
- Electrostatic discharge: IEC 1000-4-2  
- Radiated field: IEC 1000-4-3  
- Fast transients: IEC 1000-4-4  
- Magnetic field at 50/60 Hz: IEC 1000-4-8

(1) Conditions of reference:  $23^\circ\text{C} \pm 3^\circ\text{K}$ , 20 % to 75 % RH, sine signal, frequency of 48 Hz to 65 Hz, distortion factor  $< 1\%$ , no DC components, external magnetic field  $< 40$  A/m, no AC magnetic field, conductor centred for measurement,  $1 \Omega$  load (1 VA)

(2) Out of reference domain.

To order	Reference
AC current clamp model C112 with operating manual	P01120314
AC current clamp model C113 with operating manual	P01120315

# Current clamps for AC current

## Models C116 and C117

C100 series

Current	1000 A
Output	1 mV/A

### Description

Thanks to their excellent technical performance (phase shift and linearity), these  $\mu$ -metal core clamps are highly recommended for wattmeter use.

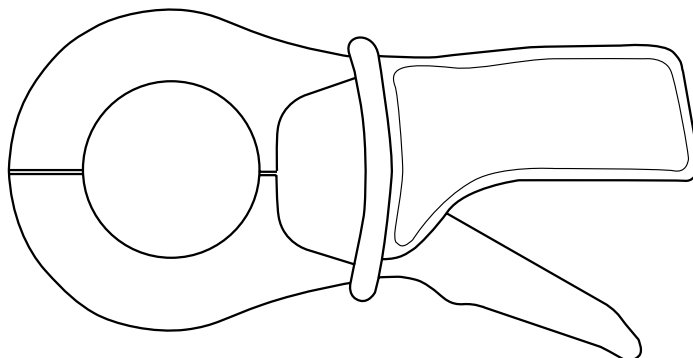

### Electrical specifications

#### Current calibre:

0.001 A AC ... 1200 A AC

#### Output signal:

1 mVAC/A AC (1 V for 1000 A)

#### Accuracy and phase shift <sup>(1)</sup>:

Primary current	1 mA...100 mA	0.1 A...1 A	1 A...10 A	10 A...100 A	100 A...1200 A
Accuracy in % of output signal	$\leq 3\% + 5 \mu A$	$\leq 2\% + 3 \mu A$	$\leq 1\%$	$\leq 0.5\%$	$\leq 0.3\%$
Phase shift	not specified	not specified	$\leq 2^\circ$	$\leq 1^\circ$	$\leq 0.7^\circ$

#### Bandwidth:

30 Hz ... 10 kHz

#### Crest factor:

$\leq 6$  for a current  $\leq 2000$  A peak (300 Arms)

#### Maximum currents:

1000 A continuous for a frequency  $\leq 1$  kHz (limitation proportional to the inverse frequency beyond)

1200 A for 40 minutes max. (interval between measurements > 20 minutes)

#### Output impedance:

$1 \Omega \pm 1\%$

#### Load impedance:

$\geq 1 M\Omega$  and  $\leq 100 pF$

#### Operating voltage:

600 V rms

#### Common mode voltage:

600 V category III and pollution degree 2

#### Influence of adjacent conductor:

$\leq 0.5$  mA/A at 50 Hz

#### Influence of conductor position in jaws:

$\leq 0.1\%$  of output signal for frequencies  $\leq 400$  Hz

#### Load influence:

On receiver, for an input impedance of  $100 \Omega$ :  $\leq 1\%$  on measurement, no measurement on phase

On receiver, for an input impedance of  $1 k\Omega$ :  $\leq 0.1\%$  on measurement, no measurement on phase

#### Influence of frequency <sup>(2)</sup>:

$< 0.5\%$  of output signal from 30 Hz ... 48 Hz

$< 1\%$  of output signal from 65 Hz ... 1 kHz

$< 2\%$  of output signal from 1 kHz ... 5 kHz

#### Influence of crest factor:

$< 1\%$  of output signal for crest factor  $\leq 6$  with current  $\leq 2000$  A peak

#### Influence of DC current superimposed on rated current:

$< 1\%$  of output signal for a current  $\leq 15$  A DC

### Mechanical specifications

#### Operating temperature:

$-10^\circ C$  to  $+50^\circ C$

#### Storage temperature:

$40^\circ C$  to  $+70^\circ C$

#### Influence of temperature:

$\leq 0.2\%$  of output signal per  $10^\circ K$

#### Relative humidity for operation:

0 to 85 % RH decreasing linearly above  $35^\circ C$

#### Influence of relative humidity:

$< 0.1\%$  of output signal from 10 % to 85 % RH

#### Operating altitude:

0 to 2,000 m

#### Max. jaw opening:

53 mm, patented progressive opening system

#### Clamping capacity:

Cable:  $\varnothing$  max 52 mm

Busbar: 1 busbar of  $50 \times 5$  mm / 4 busbars of  $30 \times 5$  mm

#### Casing protection rating:

IP40 (IEC 529)

#### Drop test:

1 m (IEC 68-2-32)

#### Shock resistance:

100 g (IEC 68-2-27)

#### Vibration resistance:

5/15 Hz 1.5 mm

15/25 Hz 1 mm

25/55 Hz 0.25 mm

(IEC 68-2-6)

#### Self-extinguishing capability:

Casing and jaws: UL94 V0

#### Dimensions:

216 x 111 x 45 mm

#### Weight:

550 g

#### Colours:

Dark grey case with red jaws

#### Output:

■ C116: safety sockets (4 mm)

■ C117: two-wire cable with reinforced insulation or double insulation, length 1.5 m, terminated by 2 insulated elbowed male banana plugs,  $\varnothing$  4 mm

### Safety specifications

#### Electrical safety:

Instrument with double insulation or reinforced insulation between the primary, the secondary and the grippable part located under the guard as per IEC 1010-1 & IEC 1010-2-032

- 600 V category III, pollution degree 2

- 300 V category IV, pollution degree 2

#### Electromagnetic compatibility (EMC):

EN 50081-1: class B

EN 50082-2:

- Electrostatic discharge: IEC 1000-4-2

- Radiated field: IEC 1000-4-3

- Fast transients: IEC 1000-4-4

- Magnetic field at 50/60 Hz: IEC 1000-4-8

(1) Conditions of reference:  $23^\circ C \pm 3^\circ K$ , 20 % to 75 % RH, sine signal, frequency of 48 Hz to 65 Hz, distortion factor  $< 1\%$ , no DC components, external magnetic field  $< 40$  A/m, no AC magnetic field, conductor centred for measurement, load impedance  $\geq 1 M\Omega$  and  $\leq 100 pF$

(2) Out of reference domain

To order	Reference
AC current clamp model C116 with operating manual	P01120316
AC current clamp model C117 with operating manual	P01120317

# Clamp-on ammeter for AC current

## Model C122

C100 series

Current	1000 A
Ratio	1000/5
Output	5 mA/A

### Description

An electronic voltage-limiting system protects output of clamp when operating, if the secondary circuit is opened accidentally.

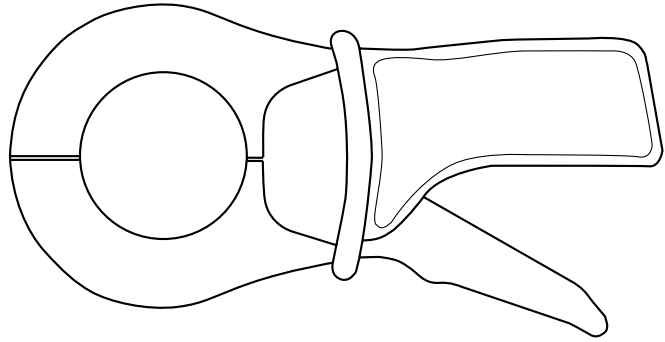

### Electrical specifications

#### Current calibre:

1 AAC ... 1200 AAC

#### Current transformation ratio:

1000:5

#### Output signal:

5 mA AC/AAC (5 A for 1000 A)

#### Accuracy and phase shift <sup>(1)</sup>:

Primary current	1 A...20 A	20 A	50 A <sup>(2)</sup>	200 A <sup>(2)</sup>	1000 A <sup>(2)</sup>	1200 A <sup>(2)</sup>
Accuracy in %	≤ 6 % + 0.5 mA	≤ 5 %	≤ 3 %	≤ 1.5 %	≤ 1 %	≤ 1 %
Phase shift	not specified	≤ 3°	≤ 3°	≤ 1.5°	≤ 1°	≤ 1°

#### Bandwidth:

30 Hz ... 10 kHz

#### Crest factor:

≤ 6 for a current ≤ 3000 A peak (500 Arms)

#### Maximum currents:

1000 A continuous for a frequency ≤ 1 kHz (limitation proportional to the inverse frequency beyond)

1200 A for 30 minutes max (interval between measurements > 15 minutes)

#### Load impedance:

≤ 0.6 Ω

#### Impedance of connection leads:

≤ 40 mΩ

#### Max. voltage at output (secondary circuit open):

Electronic limiter 30 V max. peak

#### Operating voltage:

600 V rms

#### Common mode voltage:

600 V category III and pollution degree 2

#### Influence of adjacent conductor:

≤ 1 mA/A at 50 Hz

#### Influence of conductor position in jaws:

≤ 0.2 % of output signal for frequencies ≤ 400 Hz

#### Load influence:

from 0.2 Ω to 0.6 Ω

< 0.5 % on measurement

< 0.5° on phase

#### Influence of frequency <sup>(3)</sup>:

< 1 % of output signal from 30 Hz ... 48 Hz

< 0.5 % of output signal from 65 Hz ... 1 kHz

< 1 % of output signal from 1 kHz ... 5 kHz

#### Influence of crest factor:

< 1 % of output signal for crest factor ≤ 6 with current ≤ 3000 A peak (500 Arms)

#### Influence of DC current superimposed on rated current:

< 1 % of output signal for a current ≤ 30 A DC

### Mechanical specifications

#### Operating temperature:

-10 °C to +50 °C

#### Storage temperature:

-40 °C to +70 °C

#### Influence of temperature:

≤ 0.1 % of output signal per 10 °K

#### Relative humidity for operation:

0 to 85 % RH with a linear decrease above 35 °C

#### Influence of relative humidity:

< 0.2 % of output signal from 10 % to 85 % RH

#### Operating altitude:

0 to 2,000 m

#### Max. jaw opening:

53 mm, patented progressive opening system

#### Clamping capacity:

- Cable: Ø max 52 mm

- Busbar: 1 busbar of 50 x 5 mm / 4 busbars of 30 x 5 mm

#### Casing protection rating:

IP40 (IEC 529)

#### Drop test:

1 m (IEC 68-2-32)

#### Shock resistance:

100 g (IEC 68-2-27)

#### Vibration resistance:

5/15 Hz 1.5 mm

15/25 Hz 1 mm

25/55 Hz 0.25 mm

(IEC 68-2-6)

#### Self-extinguishing capability:

Casing and jaws: UL94 V0

#### Dimensions:

216 x 111 x 45 mm

#### Weight:

550 g

#### Colours:

Dark grey case with red jaws

#### Output:

Safety sockets (4 mm)

### Safety specifications

#### Electrical safety:

Instrument with double insulation or reinforced insulation between the primary, the secondary and the grippable part located under the guard as per IEC 1010-1 & IEC 1010-2-032

- 600 V category III, pollution degree 2

- 300 V category IV, pollution degree 2

#### Electromagnetic compatibility (EMC):

EN 50081-1: class B

EN 50082-2:

- Electrostatic discharge: IEC 1000-4-2

- Radiated field: IEC 1000-4-3

- Fast transients: IEC 1000-4-4

- Magnetic field at 50/60 Hz: IEC 1000-4-8

(1) Conditions of reference: 23 °C ± 3 °K, 20 % to 75 % RH, sine signal, frequency of 48 Hz to 65 Hz, distortion factor < 1 %, no DC components, external magnetic field < 40 A/m, no AC magnetic field, conductor centred for measurement, load impedance 0.2 Ω (5 VA)

(2) Accuracy class in accordance with IEC 185: 5 VA - class 1 - 48 ... 65 Hz

(3) Out of reference domain

To order	Reference
AC current clamp model C122 with operating manual	P01120306

# Current clamp for AC current

## Model C148

C100 series

Current	250 A AC	500 A AC	1000 A AC
Ratio	250:5	500:5	1000:5
Output	20 mA/A	10 mA/A	5 mA/A

### Description

An electronic voltage-limiting system protects output of clamp when operating if the secondary circuit is opened accidentally.

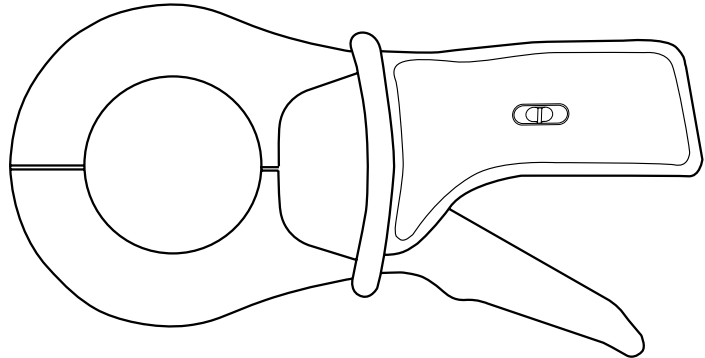

### Electrical specifications

#### Current calibres:

1 A AC...300 A AC  
1 A AC...600 A AC  
1 A AC...1200 A AC

#### Current transformation ratio

250:5  
500:5  
1000:5

#### Output signal:

20 mA AC/A AC (5 A for 250 A)  
10 mA AC/A AC (5 A for 500 A)  
5 mA AC/A AC (5 A for 1000 A)

#### Accuracy and phase shift <sup>(1)</sup>:

##### ■ 250 A calibre

Primary current	1 A...5 A	5 A	12.5 A <sup>(2)</sup>	50 A <sup>(2)</sup>	250 A <sup>(2)</sup>	300 A <sup>(2)</sup>
Accuracy in %	≤ 10 % + 2 mA	≤ 10 %	≤ 5 %	≤ 2.5 %	≤ 2 %	≤ 2 %
Phase shift	not specified	not specified	≤ 10°	≤ 10°	≤ 10°	≤ 10°

##### ■ 500 A calibre

Primary current	1 A...10 A	10 A	25 A <sup>(3)</sup>	100 A <sup>(3)</sup>	500 A <sup>(3)</sup>	600 A <sup>(3)</sup>
Accuracy in %	≤ 6 % + 1 mA	≤ 6 %	≤ 3 %	≤ 2 %	≤ 1 %	≤ 1 %
Phase shift	not specified	≤ 6°	≤ 4°	≤ 3°	≤ 2.5°	≤ 2.5°

##### ■ 1000 A calibre

Primary current	1 A...20 A	20 A	50 A <sup>(4)</sup>	200 A <sup>(4)</sup>	1000 A <sup>(4)</sup>	1200 A <sup>(4)</sup>
Accuracy in %	≤ 6 % + 0.5 mA	≤ 5 %	≤ 3 %	≤ 1.5 %	≤ 1 %	≤ 1 %
Phase shift	not specified	≤ 5°	≤ 3°	≤ 1.5°	≤ 1°	≤ 1°

#### Bandwidth:

48 Hz...1 kHz

#### Crest factor:

■ 250 A calibre:  
≤ 6 with current ≤ 750 A peak  
■ 500 A calibre:  
≤ 6 with current ≤ 1500 A peak  
■ 1000 A calibre:  
≤ 6 with current ≤ 3000 A peak

#### Maximum currents:

1200 A for frequencies ≤ 1 kHz for 30 minutes max. (interval between measurements > 15 minutes)

#### Load impedance:

■ 250 A calibre: ≤ 0.2 Ω  
■ 500 A calibre: ≤ 0.4 Ω  
■ 1000 A calibre: ≤ 0.4 Ω

#### Impedance of connection leads:

≤ 40 mΩ

#### Max. voltage at output (secondary circuit open):

Electronic limiter 30 V max. peak

#### Operating voltage:

600 V rms

#### Common mode voltage:

600 V category III and pollution degree 2

#### Influence of adjacent conductor:

■ 250 A calibre: ≤ 15 mA/A at 50 Hz  
■ 500 A calibre: ≤ 10 mA/A at 50 Hz  
■ 1000 A calibre: ≤ 1 mA/A at 50 Hz

#### Influence of conductor position in jaws:

for frequencies ≤ 400 Hz

■ 250 A calibre: ≤ 0.6 % of output signal  
■ 500 A calibre: ≤ 0.4 % of output signal  
■ 1000 A calibre: ≤ 0.2 % of output signal

#### Load influence:

■ 250 A calibre: from 25 mΩ to 0.2 Ω  
< 2 % on measurement  
< 4° on phase

■ 500 A calibre: from 50 mΩ to 0.4 Ω  
< 1 % on measurement  
< 2° on phase

■ 1000 A calibre: from 50 mΩ to 0.4 Ω  
< 0.5 % on measurement  
< 0.5° on phase

#### Influence of frequency <sup>(5)</sup>:

■ 250 A calibre:  
< 1 % of output signal from 65 Hz...100 Hz  
< 5 % of output signal from 100 Hz...1 kHz

■ 500 A calibre:  
< 1 % of output signal from 65 Hz...1 kHz

■ 1000 A calibre:  
< 0.5 % of output signal from 65 Hz...100 Hz  
< 1 % of output signal from 100 Hz...1 kHz

#### Influence of crest factor:

< 1 % of output signal for crest factor ≤ 6 with current:  
≤ 750 A peak (250 A calibre)  
≤ 1500 A peak (500 A calibre)  
≤ 3000 A peak (1000 A calibre)

#### Influence of DC current superimposed on rated current:

< 1 % of output signal for a current ≤ 30 A DC

# Current clamp for AC current

## Model C148

C100 series

### ■ Mechanical specifications

**Operating temperature:**  
-10 °C to +50 °C

**Storage temperature:**  
-40 °C to +70 °C

**Influence of temperature:**  
≤ 0.15 % of output signal per 10 °K

**Relative humidity for operation:**  
0 to 85 % RH decreasing linearly above 35 °C

**Influence of relative humidity:**  
10 % to 85 % RH

■ 250 A calibre:  
< 0.6 % of output signal and < 2° on phase

■ 500 A calibre:  
< 0.4 % of output signal and < 0.6° on phase

■ 1000 A calibre:  
< 0.2 % of output signal and < 0.2° on phase

**Operating altitude:**  
0 to 2,000 m

**Max. jaw opening:**  
53 mm  
Patented progressive opening system

**Clamping capacity:**

Cable: Ø max 52 mm  
Busbar: 1 busbar of 50 x 5 mm / 4 busbars of 30 x 5 mm

**Casing protection rating:**  
IP40 (IEC 529)

**Drop test:**  
1 m (IEC 68-2-32)

**Shock resistance:**  
100 g (IEC 68-2-27)

**Vibration resistance:**  
5/15 Hz 1.5 mm  
15/25 Hz 1 mm  
25/55 Hz 0.25 mm  
(IEC 68-2-6)

**Self-extinguishing capability:**  
UL94 V0

**Dimensions:**  
216 x 111 x 45 mm

**Weight:**  
550 g

**Colours:**  
Dark grey case with red jaws

**Output:**  
Safety sockets (4 mm)

### ■ Safety specifications

**Electrical safety:**

Instrument with double insulation or reinforced insulation between the primary, the secondary and the grippable part located under the guard as per IEC 1010-1 & IEC 1010-2-032

- 600 V category III, pollution degree 2
- 300 V category IV, pollution degree 2

**Electromagnetic compatibility (EMC):**

EN 50081-1: class B

EN 50082-2:

- Electrostatic discharge: IEC 1000-4-2
- Radiated field: IEC 1000-4-3
- Fast transients: IEC 1000-4-4
- Magnetic field at 50/60 Hz: IEC 1000-4-8

(1) Conditions of reference: 23 °C ± 3 °K, 20 % to 75 % RH, sine signal, frequency of 48 Hz to 65 Hz, distortion factor < 1 %, external magnetic field < 40 A/m, no AC magnetic field, conductor centred for measurement, load impedance:

- 250 A calibre: 0.1 Ω (2.5 VA)
- 500 A calibre: 0.2 Ω (5 VA)
- 1000 A calibre: 0.2 Ω (5 VA)

(2) Accuracy class in accordance with IEC 185: 2.5 VA - class 3 - 48-65 Hz

(3) Accuracy class in accordance with IEC 185: 5 VA - class 3 - 48-65 Hz

(4) Accuracy class in accordance with IEC 185: 5 VA - class 1 - 48-65 Hz

(5) Out of reference domain

To order	Reference
AC current clamp model C148 with operating manual	P01120307



## Model C160 (insulated AC current probe)

<b>Current</b>	30 A peak	300 A peak	2000 A peak
<b>Output</b>	100 mV/A	10 mV/A	1 mV/A

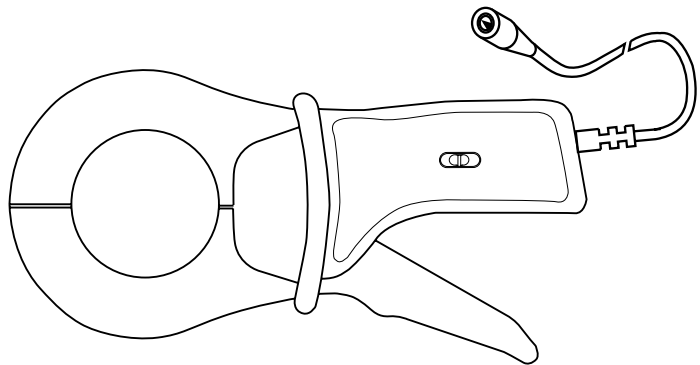

### Description

This 1,000 A AC clamp can be used for easy display and measurement of current curves. Equipped with a coaxial cable terminated by a BNC connector, it is ideal for use with any oscilloscope. It outputs a signal in mV directly proportional to the current. It offers 3 different sensitivities.

### Electrical specifications

#### Current calibres:

- 0.1 A AC...10 A AC (30 A peak)
- 1 A AC...100 A AC (300 A peak)
- 1 A AC...1000 A AC (2000 A peak)

#### Output signal:

- 100 mVAC/AAC (1 V for 10 A)
- 10 mVAC/AAC (1 V for 100 A)
- 1 mAAC/AAC (1 V for 1000 A)

#### Accuracy and phase shift <sup>(1)</sup>:

##### 10 A calibre

Primary current	0.1 A...0.5 A	0.5 A...2 A	2 A...10 A	10 A...12 A
% Accuracy of output signal	≤ 3 % + 10 mV	≤ 3 % + 10 mV	≤ 3 % + 10 mV	≤ 3 % + 10 mV
Phase shift	not specified	not specified	≤ 15°	≤ 15°

##### 100 A calibre

Primary current	0.1 A...5 A	5 A...20 A	20 A...100 A	100 A...120 A
% Accuracy of output signal	≤ 2 % + 5 mV	≤ 2 % + 5 mV	≤ 2 % + 5 mV	≤ 2 % + 5 mV
Phase shift	not specified	≤ 15°	≤ 10°	≤ 5°

##### 1000 A calibre

Primary current	1 A...50 A	50 A...200 A	200 A...1000 A	1000 A...1200 A
% Accuracy of output signal	≤ 1 % + 1 mV	≤ 1 % + 1 mV	≤ 1 % + 1 mV	≤ 1 % + 1 mV
Phase shift	not specified	≤ 3°	≤ 2°	≤ 1°

#### Bandwidth:

10 Hz...100 kHz (-3 dB) (depending on current value)

#### Rise/fall time from 10 % to 90 %:

3.5 μs

#### 10 % delay time:

0.5 μs

#### Ampere second product:

- 10 A calibre: 3.2 A.s
- 100 A calibre: 26 A.s
- 1000 A calibre: 64 A.s

#### Maximum currents:

1000 A permanent  
1200 A for 40 minutes max. / > 20 minutes shutdown for a frequency ≤ 1 kHz (limitation proportional to the inverse of one third of the frequency beyond that)

#### Insertion impedance (at 400 Hz / 10 kHz)

- 10 A calibre: < 0.3 mΩ / < 6,6 mΩ
- 100 A calibre: < 0.3 mΩ / < 2 mΩ
- 1000 A calibre: < 0.3 mΩ / < 1.6 mΩ

#### Output impedance at 1 kHz:

- 10 A calibre: ≤ 515 Ω ± 10 %
- 100 A calibre: ≤ 515 Ω ± 10 %
- 1000 A calibre: ≤ 515 Ω ± 10 %

#### Influence of temperature:

≤ 150 ppm /k or 0.15 % of output signal per 10 °K

#### Influence of relative humidity:

< 0.1 % of output signal

#### Influence of adjacent conductor:

≤ 1 mA/A at 50 Hz

#### Influence of DC current superimposed on rated current:

< 1 % of output signal for a current ≤ 30 A DC

#### Influence of conductor position in jaws:

≤ 0.1 % of output signal for frequencies ≤ 400 Hz

#### Influence of frequency <sup>(2)</sup>:

##### 10 A calibre:

- < 10 % of output signal from 10 Hz to 1 kHz
- < 5 % of output signal from 1 kHz to 10 kHz
- < 20 % of output signal from 10 kHz to 50 kHz
- 3 dB of output signal from 50 kHz to 100 kHz

##### 100 A calibre:

- < 5 % of output signal from 10 Hz to 1 kHz
- < 3 % of output signal from 1 kHz to 10 kHz
- < 20 % of output signal from 10 kHz to 50 kHz
- 3 dB of output signal from 50 kHz to 100 kHz

##### 1000 A calibre:

- < 1 % of output signal from 10 Hz to 1 kHz
- < 2 % of output signal from 1 kHz to 10 kHz
- < 10 % of output signal from 10 kHz to 50 kHz
- 3 dB of output signal from 50 kHz to 100 kHz

#### Influence of crest factor:

< 1 % of output signal for crest factor ≤ 6 with current

- 10 A calibre: ≤ 30 A peak
- 100 A calibre: ≤ 300 A peak
- 1000 A calibre: ≤ 3000 A peak

## Model C160 (insulated AC current probe)

### ■ Mechanical specifications

**Max. jaw opening:**  
53 mm

**Clamping capacity:**

Cable:  $\varnothing$  max 52 mm

Busbar: 1 busbar of 50 x 5 mm / 4 busbars of 30 x 5 mm

**Operating temperature:**

-10 °C to +55 °C

**Storage temperature:**

-40 °C to +70 °C

**Relative humidity for operation:**

0 to 85 % RH decreasing linearly above 35 °C

**Operating altitude:**

0 to 2,000 m

**Casing protection rating:**

IP30 with clamp open (IEC 529)

IP40 with clamp closed (IEC 529)

**Drop test:**

1 m (IEC 68-2-32)

**Shock resistance:**

100 g / 6 ms / half-period (IEC 68-2-27)

**Protection against impacts:**

IK04 0.5 J (EN 50102)

**Vibration resistance:**

5/15 Hz 1.5 mm peak

15/25 Hz 1 mm peak

25/55 Hz 0.25 mm peak

(IEC 68-2-6)

**Self-extinguishing capability:**

Casing and jaws: UL94 V0

**Dimensions:**

216 x 111 x 45 mm

**Weight:**

550 g

**Colours:**

Dark grey case with red jaws

**Output:**

2 m coaxial lead with insulated BNC plug

### ■ Safety specifications

**Electrical safety:**

Instrument with double insulation or reinforced insulation between the primary, the secondary and the grippable part located under the guard as per IEC 1010-1 & IEC 1010-2-032

- 600 V category III, pollution degree 2

- 300 V category IV, pollution degree 2

**Electromagnetic compatibility (EMC):**

EN 50081-1: class B

EN 50082-2:

- Electrostatic discharge: IEC 1000-4-2

without disturbance: 4 kV class 2

non-destructive: 15 kV class 4

- Radiated field: IEC 1000-4-3

without disturbance: 10 V/m performance criterion A

- Fast transients: IEC 1000-4-4

without disturbance: 1 kV class 2

non-destructive: 2 kV class 3

- Magnetic field at 50/60 Hz: IEC 1000-4-8

field of 400 A/m at 50 Hz: < 1 A

(1) Conditions of reference: 23 °C  $\pm$  3 °K, 20 % to 75 % RH, sine signal, frequency of 48 Hz to 1000 Hz, distortion factor < 1 % with no DC component, external magnetic field < 40 A/m, no DC components, no external conductor with circulating current, conductor centred for measurement, load impedance:  $\geq$  1 M $\Omega$  and < 100 pF

(2) Out of reference domain

To order	Reference
AC current clamp model C160 with operating manual	P01120308

# Oscilloscope clamp for AC current

## Model C160 (insulated AC current probe)

C100 series

### ■ Curves at 50 Hz

#### 1000 A calibre

Error on measurement

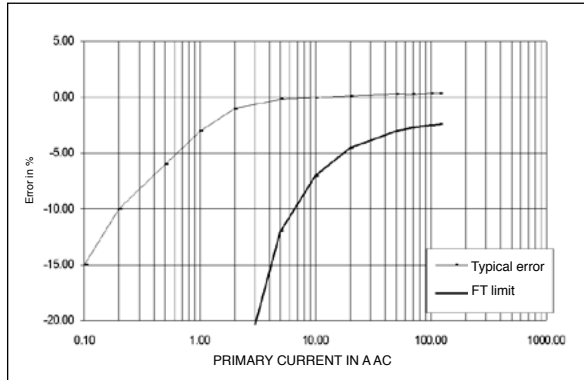

Phase shift

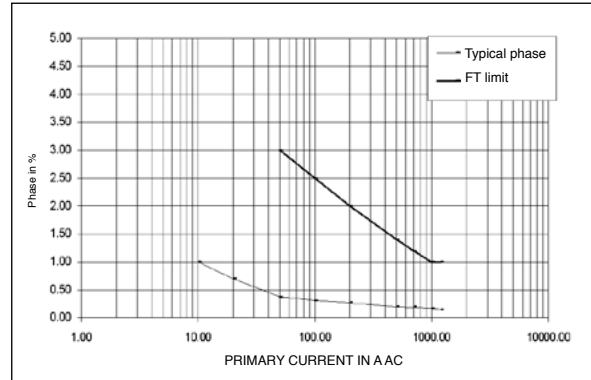

#### 100 A calibre

Error on measurement

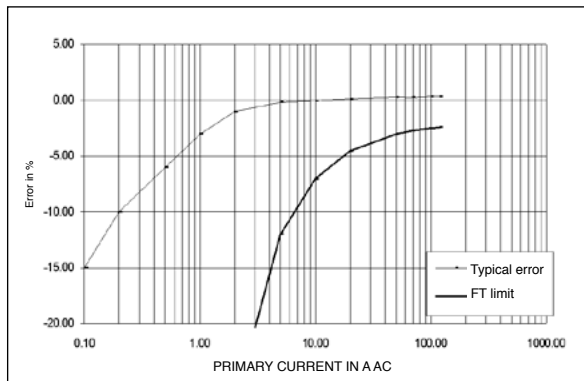

Phase shift

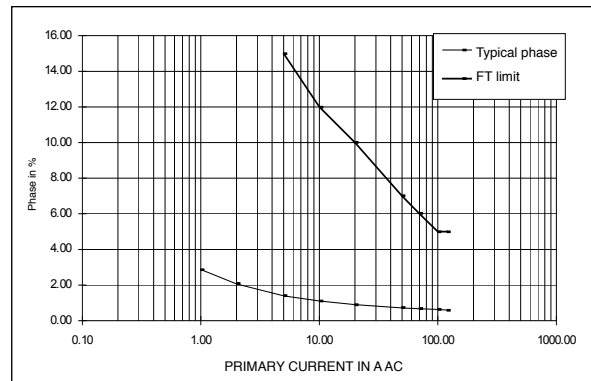

#### 10 A calibre

Error on measurement

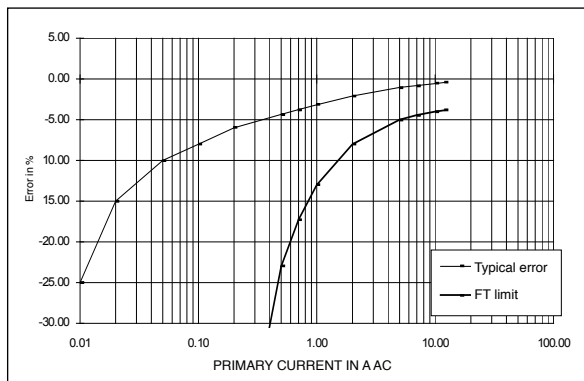

Phase shift

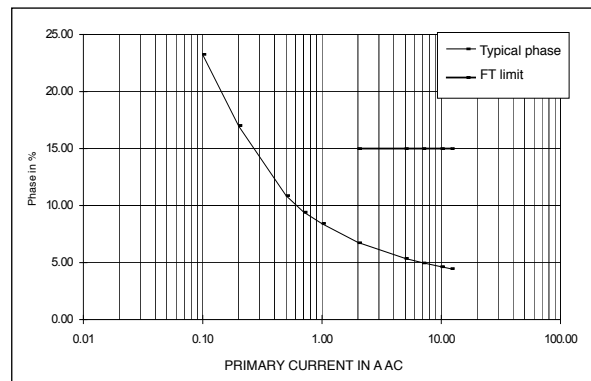

# Oscilloscope clamp for AC current

## Model C160 (insulated AC current probe)

C100 series

### ■ Frequency response (cont.)

1000 A calibre

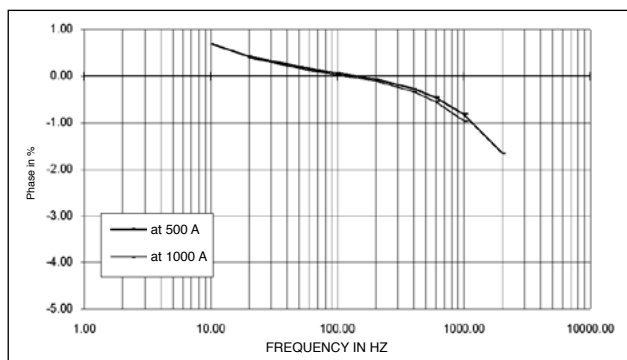
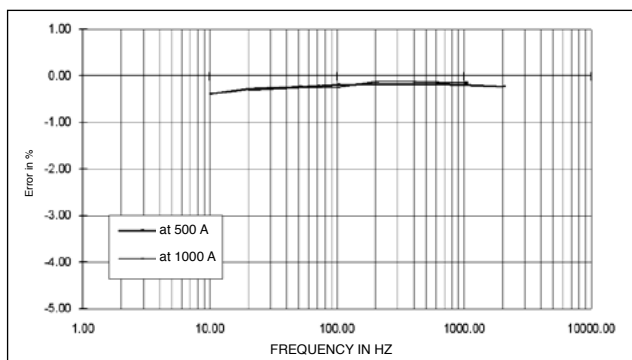
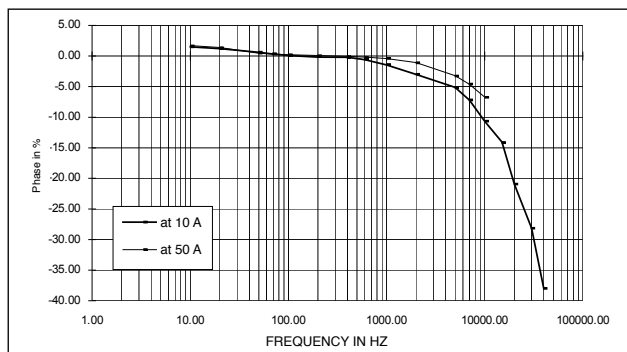
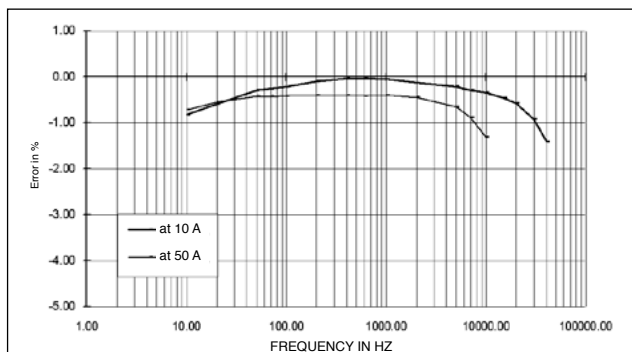

100 A calibre

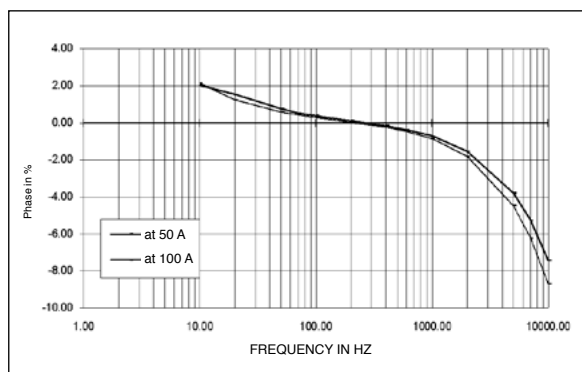
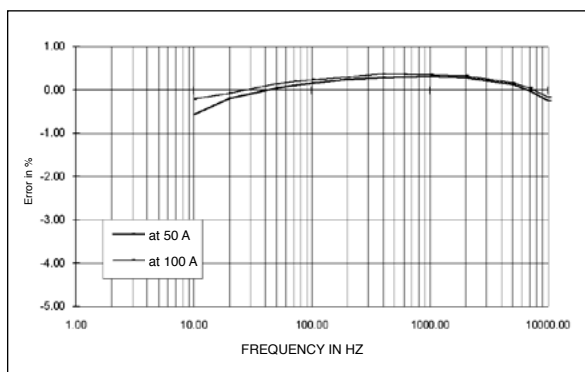
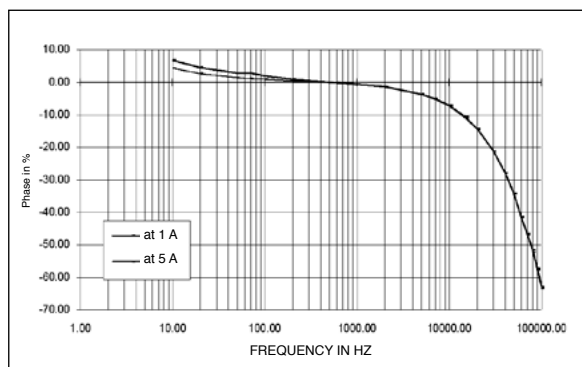
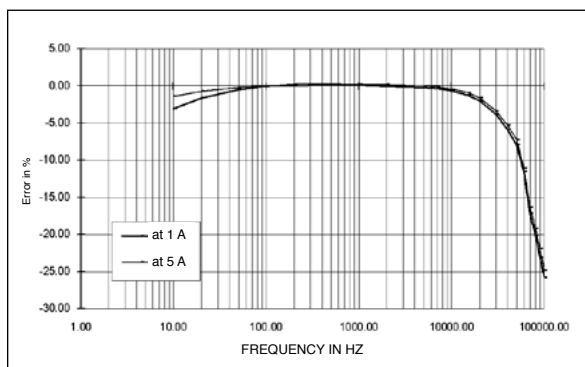

# Oscilloscope clamp for AC current

## Model C160 (insulated AC current probe)

C100 series

### Frequency response (cont.)

10 A calibre

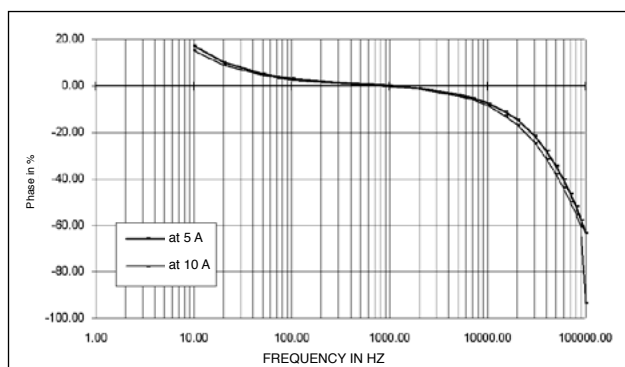
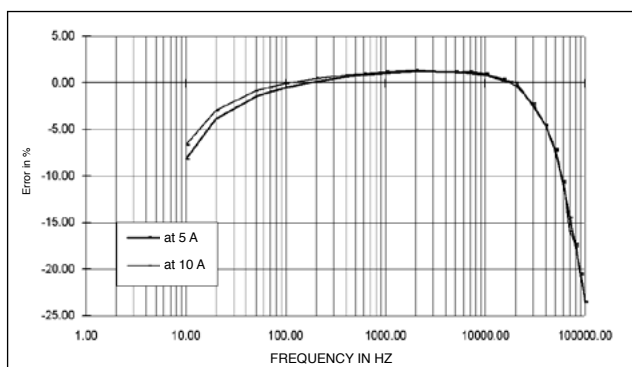
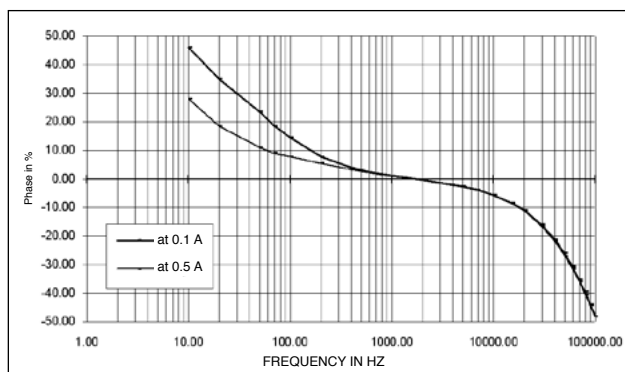
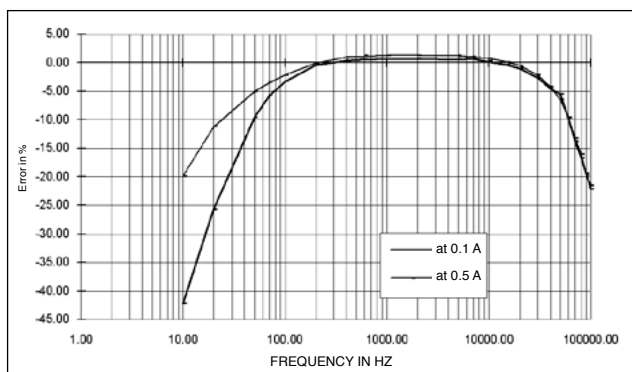

### Response to a square signal

1000 A calibre

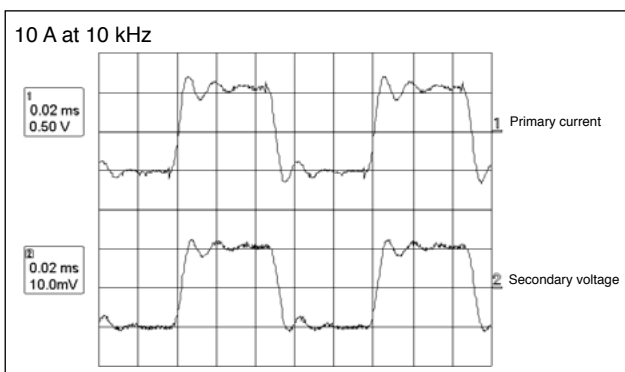
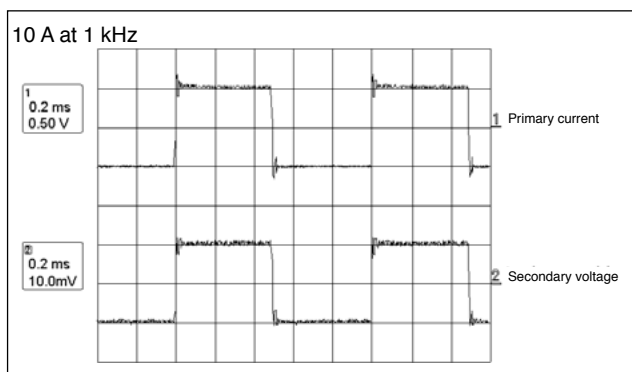
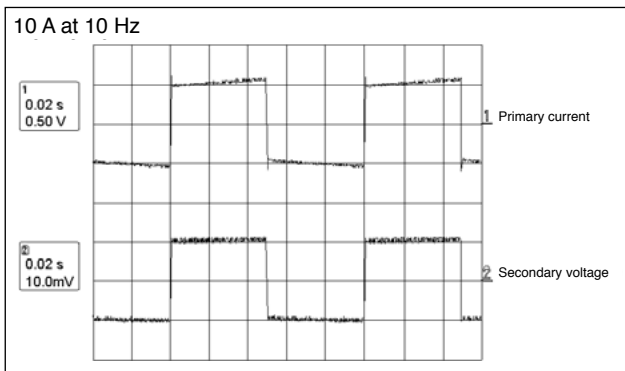
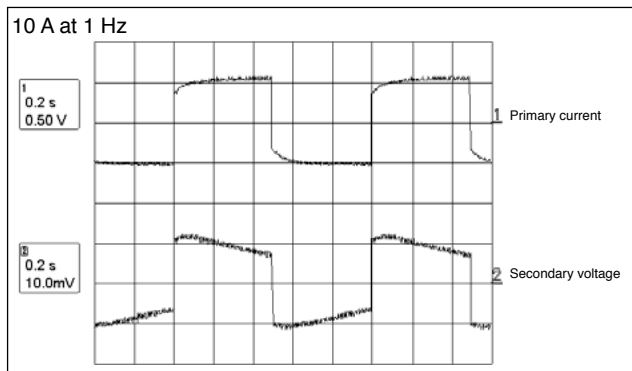

# Oscilloscope clamp for AC current

## Model C160 (insulated AC current probe)

### ■ Response to a square signal (cont.)

100 A calibre

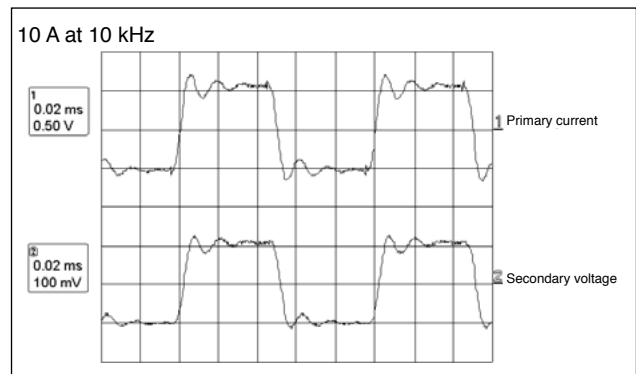
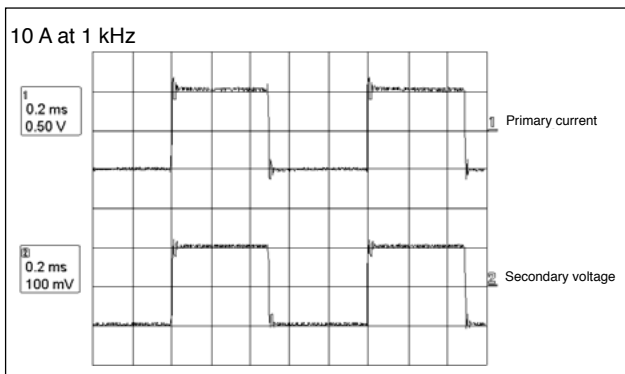
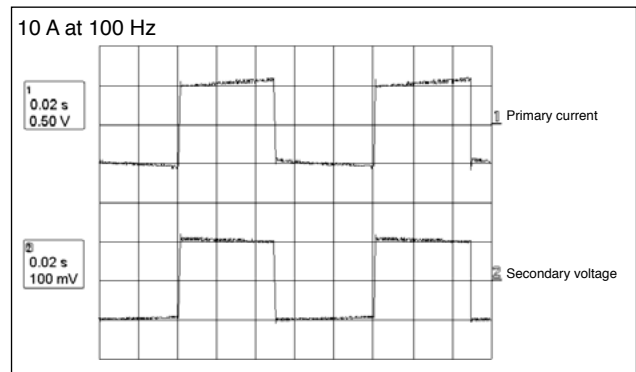
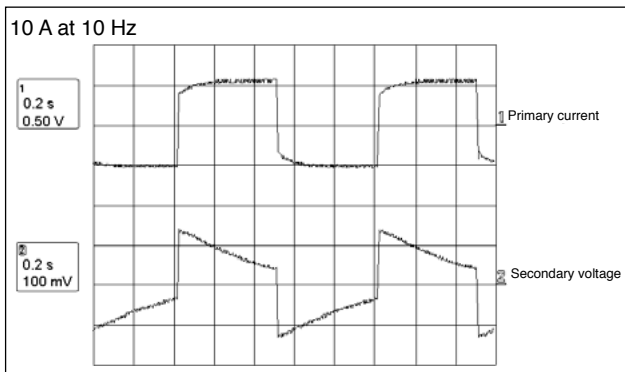

10 A calibre

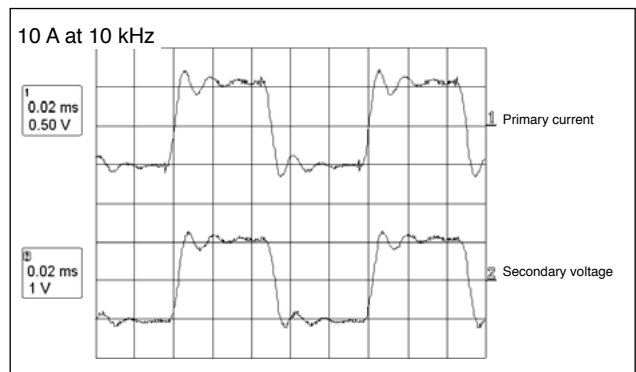
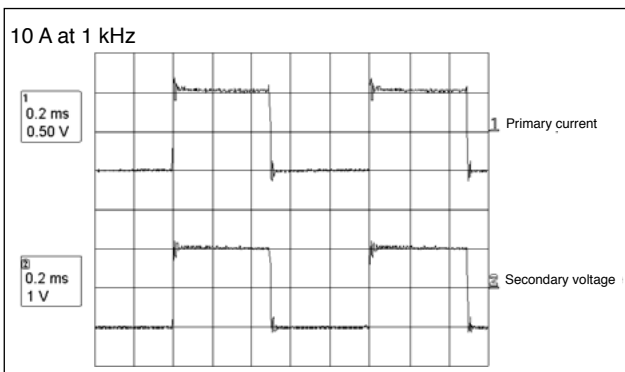
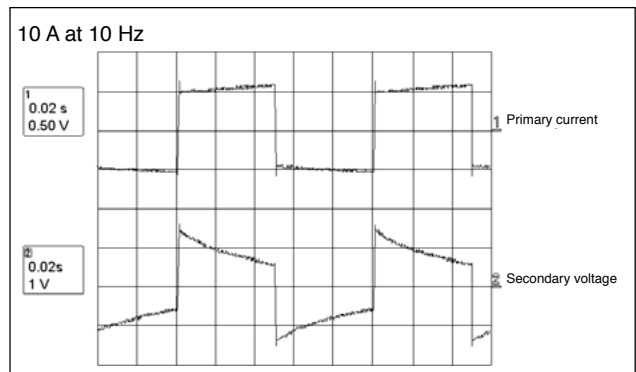
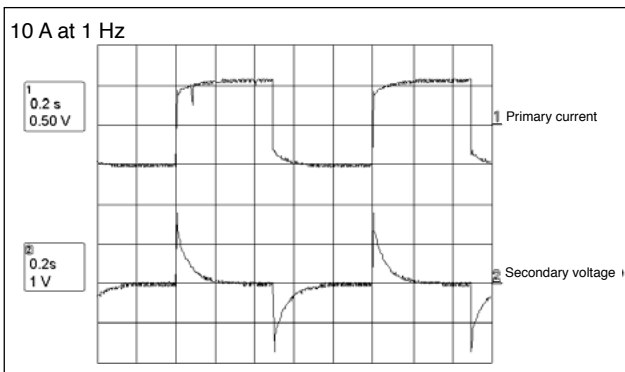

# Current clamp for AC current

## Model C173 (probe for leakage currents)

C100 series

<b>Current</b>	1 A	10 A	100 A	1000 A
<b>Output</b>	1 V/A	100 mV/A	10 mV/A	1 mV/A

### Description

The C173 clamp measures leakage or differential currents from 1 mA upwards and can also be used with multimeters equipped with a range in mV AC.

The C173 clamp measures earth-loop currents and leakage currents. It also locates faults in circuits of single and three-phase networks.

For unearthed three-phase systems, use the optional Artificial Neutral.

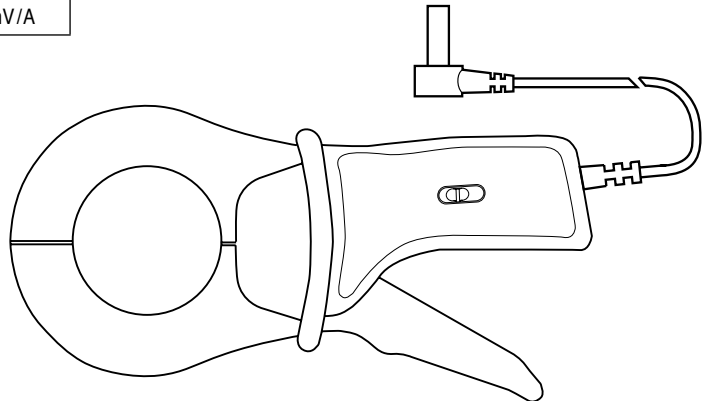

### Electrical specifications

#### Current calibres:

0.001 A AC...1.2 A AC  
 0.01 A AC...12 A AC  
 0.1 A AC...120 A AC  
 1 A AC...1200 A AC

#### Output signal:

1 VAC/AAC (1 V for 1 A)  
 100 mVAC/AAC (1 V for 10 A)  
 10 mVAC/AAC (1 V for 100 A)  
 1 mVAC/AAC (1 V for 1000 A)

#### Accuracy and phase shift<sup>(1)</sup>:

##### 1 A calibre

Primary current	0.001 A...0.01 A	0.01 A...0.1 A	0.1 A...1 A	1 A...1.2 A
% Accuracy of output signal	≤ 3 % + 1 mV	≤ 3 % + 1 mV	≤ 0.7 % + 1 mV	≤ 0.7 % + 1 mV
Phase shift	not specified	not specified	≤ 10°	≤ 10°

##### 10 A calibre

Primary current	0.01 A...0.1 A	0.1 A...1 A	1 A...10 A	10 A...12 A
Accuracy in % of output signal	≤ 1 % + 0.2 mV	≤ 0.5 % + 0.2 mV	≤ 0.5 %	≤ 0.5 %
Phase shift	not specified	≤ 5°	≤ 2°	≤ 2°

##### 100 A calibre

Primary current	0.1 A...1 A	1 A...10 A	10 A...100 A	100 A...120 A
Accuracy in % of output signal	≤ 1 % + 0.2 mV	≤ 0.5 % + 0.2 mV	≤ 0.3 %	≤ 0.2 %
Phase shift	not specified	≤ 2°	≤ 1°	≤ 1°

##### 1000 A calibre

Primary current	1 A...10 A	10 A...100 A	100 A...1000 A	1000 A...1200 A
% Accuracy of output signal	≤ 1 % + 0.2 mV	≤ 0.5 % + 0.2 mV	≤ 0.2 %	≤ 0.2 %
Phase shift	not specified	≤ 2°	≤ 1°	≤ 1°

#### Bandwidth:

10 Hz ... 3 kHz

#### Crest factor:

- 1 A calibre:  
≤ 3 for I ≤ 3 A peak (1 Arms)
- 10 A calibre:  
≤ 3 for I ≤ 30 A peak (10 Arms)
- 100 A calibre:  
≤ 3 for I ≤ 300 A peak (100 Arms)
- 1000 A calibre:  
≤ 3 for I ≤ 1700 A peak (500 Arms)

#### Maximum currents:

1000 A continuous for a frequency ≤ 500 Hz (limitation proportional to the inverse of 1/2 of frequency beyond)

#### Load impedance:

≥ 10 MΩ and ≤ 47 pF

#### Output impedance:

- 1 A calibre: 10 kΩ ± 10 %
- 10 A calibre: 1 kΩ ± 10 %
- 100 A calibre: 100 Ω ± 10 %
- 1000 A calibre: 100 Ω ± 10 %

#### Operating voltage:

600 Vrms

#### Common mode voltage:

600 V category III and pollution degree 2

#### Influence of adjacent conductor:

≤ 1 mA/A at 50 Hz

#### Influence of conductor position in jaws:

≤ 0.3 % of output signal for frequencies ≤ 400 Hz

#### Influence of frequency<sup>(2)</sup>:

- 1 A calibre:  
< 2 % of output signal 30 Hz...48 Hz and 65 Hz...1 kHz  
< 10 % of output signal 1 kHz...3 kHz
- 10 A calibre:  
< 2 % of output signal 10 Hz...48 Hz and 65 Hz...3 kHz
- 100 A calibre:  
< 1.5 % of output signal 10 Hz...48 Hz and 65 Hz...3 kHz
- 1000 A calibre:  
< 1 % of output signal 10 Hz...48 Hz and 65 Hz...1 kHz

#### Influence of crest factor:

≤ 0.5 % for crest factor limited to 3

#### Influence of DC current superimposed on rated current:

≤ 10 % at 1000 A for a DC current of 10 A

# Current clamp for AC current

## Model C173 (probe for leakage currents)

C100 series

### ■ Mechanical specifications

**Operating temperature:**  
-10 °C ... +50 °C

**Storage temperature:**  
-40 °C ... +70 °C

**Influence of temperature:**  
≤ 0.15 % of output signal per 10 °K from -10 °C ... +40 °C  
≤ 0.2 % of output signal per 10 °K from +40 °C ... +50 °C

**Relative humidity for operation:**  
0 ... 85 % RH with a linear decrease above 35 °C

**Influence of relative humidity:**  
< 0.1 % of output signal from 10 % to 85 % RH

**Operating altitude:**  
0 to 2,000 m

**Max. jaw opening:**  
53 mm  
Patented progressive opening system

**Clamping capacity:**  
Cable: Ø max 52 mm  
Busbar: 1 busbar of 50 x 5 mm or 4 busbars of 30 x 5 mm

**Casing protection rating:**  
IP40 (IEC 529)

**Drop test:**  
1 m (IEC 68-2-32)

**Shock resistance:**  
100 g (IEC 68-2-27)

**Vibration resistance:**  
5/15 Hz 1.5 mm  
15/25 Hz 1 mm  
25/55 Hz 0.25 mm  
(IEC 68-2-6)

**Self-extinguishing capability:**  
UL94 V0

**Dimensions:**  
216 x 111 x 45 mm

**Weight:**  
550 g

**Colours:**  
Dark grey case with red jaws

**Output:**  
1.5 m two-wire lead with double or reinforced insulation terminated by 2 elbowed male safety plugs (4 mm)

### ■ Safety specifications

**Electrical safety:**  
Instrument with double insulation or reinforced insulation between the primary, the secondary and the grippable part located under the guard as per IEC 1010-1 & IEC 1010-2-032

- 600 V category III, pollution degree 2  
- 300 V category IV, pollution degree 2

**Electromagnetic compatibility (EMC):**

EN 50081-1: class B

EN 50082-2:

- Electrostatic discharge: IEC 1000-4-2  
- Radiated field: IEC 1000-4-3  
- Fast transients: IEC 1000-4-4  
- Magnetic field at 50/60 Hz: IEC 1000-4-8

(1) Conditions of reference: 23 °C ± 3 °K, 20 % to 75 % RH, sine signal, frequency of 48 Hz to 65 Hz, distortion factor < 1 %, no DC components, external magnetic field < 40 A/m, no AC magnetic field, conductor centred for measurement, load impedance: ≥ 10 MΩ and ≤ 47 pF

(2) Out of reference domain

To order	Reference
AC current clamp model <b>C173</b> with operating manual	P01120309
Accessory: <b>AN1</b> artificial neutral box (see chapter 12)	P01197201
Bag n°11	P01100120





## **D<sub>N</sub> series**

The D<sub>N</sub> series comprises a range of high-performance clamp-on AC current probes designed for high current measurements.

Their excellent current transformation ratios and low phase shift, combined with a broad frequency response, allows highly accurate current and power measurements.

High-quality magnetic cores and windings mean high-precision current measurement up to 3000 A (AC).

The rectangular jaws can be used to clamp large-diameter cables or busbars.

The D<sub>N</sub> series clamps provide true RMS measurement values and faithful signal reproduction.

There are two different kinds of model available in the D series: the first acts as a traditional current transformer with a current output (mA) and has a wide range of voltage ratios.

These clamps may also be used with multimeters, harmonic and power measurement equipment, logging apparatus or other instruments allowing AC current input.

The second type of model gives a voltage output in precise proportion to the measured current (1 mV/A, 10 mV/A or 100 mV/A) so you can display and log currents on instruments without current inputs.

Model D38N has been specifically designed for use with oscilloscopes, or other instruments with a BNC input.

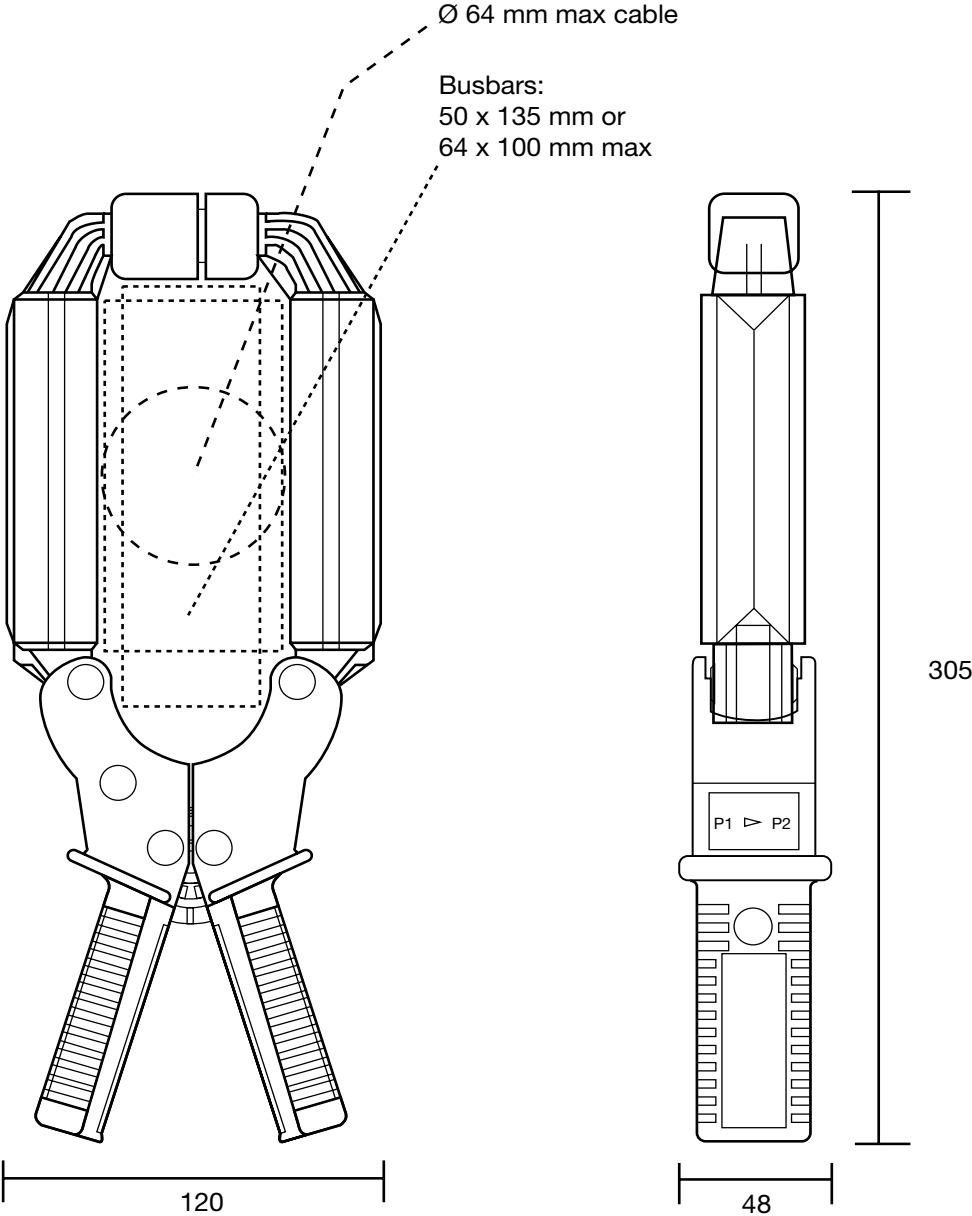

# Current clamps for AC current

## Models D30N and D30CN

DN series

Current	2400 A AC
Ratio	3000:1
Output	0.333 mA/A

### Electrical specifications

**Current calibre:**  
1 A AC ...2400 A AC  
(3000 A for temperature < 35 °C)

**Current transformation ratio:**  
3000:1

**Output signal:**  
0.333 mA/A AC (1 A for 3000 A)

**Accuracy and phase shift <sup>(1)</sup>:**

Primary current	150 A	600 A	3000 A
% Accuracy of output signal	1.5 %	0.75 %	0.5 %
Phase shift	1.5°	0.75°	0.5°

**Overload:**  
3600 A for 5 minutes

**Maximum output voltage (secondary open):**  
Electronic protection limiting the voltage to 42 V peak max.

**Accuracy:**  
In accordance with IEC 185-26-27, 5 VA, class 0.5 from 48 Hz to 1000 Hz

**Bandwidth:**  
30 Hz to 5 kHz (in continuous use above 1 kHz, the max. measurement current is limited)

**Ampere second product:**  
90 A.s

**Load impedance:**  
< 5 Ω

**Operating voltage:**  
600 V AC

**Common mode voltage:**  
600 V AC

**Influence of adjacent conductor:**  
0.005 A/A AC

**Influence of conductor position in jaws:**  
1 % ± 0.1 A

### Mechanical specifications

**Operating temperature:**  
-10 °C to +50 °C

**Storage temperature:**  
-25 °C to +80 °C

**Influence of temperature:**  
< 0.1 % per 10°K

**Max. jaw opening:**  
90 mm

**Max. jaw insertion capacity:**  
Cable: 64 mm  
Group of wires: 50 x 135 mm - 64 x 100 mm

**Casing protection rating:**  
IP20 in accordance with IEC 529

**Drop test:**  
500 mm (IEC 68-2-32)

**Shock resistance:**  
100 g, in accordance with IEC 68-2-27

**Vibration resistance:**  
10/55/10Hz, 0.15 mm test in accordance with IEC 68-2-6

**Self-extinguishing capability:**  
Casing: UL94 V0  
Jaws: UL94 V2

**Dimensions:**  
120 x 315 x 48 mm

**Weight:**  
1200 g

**Colour:**  
Dark grey casing with red jaws

**Output:**  
■ D30N: two safety sockets (4 mm)  
■ D30CN: two-wire 1.5 m cable with reinforced insulation or double insulation ending with 2 elbowed 4 mm male safety plugs

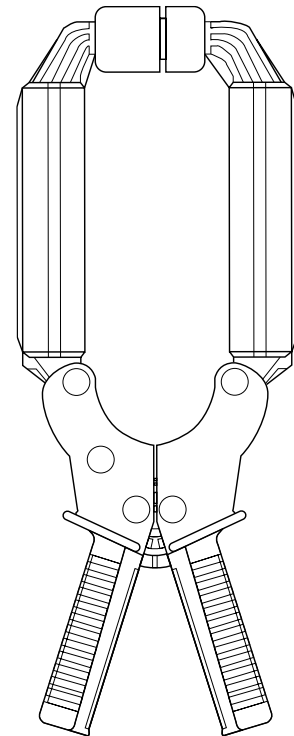

### Safety specifications

**Electrical safety:**  
Double insulation or reinforced insulation between the primary and the secondary circuits and the outside casing in accordance with IEC 1010-2-032.  
- 600 V category III, pollution degree 2  
- 300 V category IV, pollution degree 2

**Electromagnetic compatibility (EMC):**  
EN 50081-1: class B  
EN 50082-2:  
- Electrical discharge IEC 1000-4-2  
- Radial field IEC 1000-4-3  
- Fast transients IEC 1000-4-4  
- Magnetic field at 50/60 Hz IEC 1000-4-8

(1) Conditions of reference: 23 °C ± 5 °K, 20 % to 75 % RH, 48 Hz to 65 Hz, external magnetic field < 40 A/m, no DC component, no current-carrying conductor nearby, centred test sample, load impedance 5 Ω.

To order	Reference
AC current clamp model <b>D30N</b> with operating manual	P01120049A
AC current clamp model <b>D30CN</b> with operating manual	P01120064

# Current clamp for AC current

## Model D31N

DN series

Current	500 A AC	1000 A AC	1500 A AC
Ratio	500:1	1000:1	1500:1
Output	2 mA/A	1 mA/A	0.66 mA/A

### Electrical specifications

#### Current calibres:

1 A AC ... 500 A AC  
1 A AC ... 1000 A AC  
1 A AC ... 1500 A AC

#### Current transformation ratio:

500:1, 1000:1, 1500:1

#### Output signal:

2 mA/A AC (1 A for 500 A)  
1 mA/A AC (1 A for 1000 A)  
0.66 mA/A AC (1 A for 1500 A)

#### Accuracy and phase shift <sup>(1)</sup>:

##### ■ 500 A calibre

Primary current	25 A	100 A	500 A
% Accuracy of output signal	4 %	3 %	3 %
Phase shift	4°	3.5°	2°

- Load impedance: 5 Ω
- Overload: 700 A for 10 minutes
- Ampere second product: 6 A.s
- Accuracy: in accordance with IEC 185-26-27, 5 VA, class 3 from 48 Hz to 1000 Hz

##### ■ 1000 A calibre

Primary current	50 A	200 A	1000 A
% Accuracy of output signal	3 %	1.5 %	1 %
Phase shift	3°	1.5°	1°

- Load impedance: 5 Ω
- Overload: 1400 A for 10 minutes
- Ampere second product: 30 A.s
- Accuracy: in accordance with IEC 185-26-27, 5 VA, class 1 from 48 Hz to 1000 Hz

##### ■ 1500 A calibre

Primary current	75 A	300 A	1500 A
% Accuracy of output signal	1.5 %	0.75 %	0.5 %
Phase shift	1.5°	0.75°	0.5°

- Load impedance: 5 Ω
- Overload: 1800 A for 10 minutes
- Ampere second product: 65 A.s
- Accuracy: in accordance with IEC 185-26-27, 5 VA, class 0.5 from 48 Hz to 1000 Hz

#### Bandwidth:

30 Hz to 1500 Hz (in continuous use above 1 kHz the max. measurement current is limited)

#### Load impedance:

< 5 Ω

#### Operating voltage:

600 V AC

#### Common mode voltage:

600 V AC

#### Max. voltage at output (secondary circuit open):

Electronic protection limiting the voltage to 42 V peak max.

#### Influence of adjacent conductor:

0.005 A/A AC

#### Influence of conductor position in jaws:

1.5 % ± 0.2 A on the 500:1 ratio  
1 % ± 0.2 A on the 1000:1 ratio  
1 % ± 0.2 A on the 1500:1 ratio

### Mechanical specifications

#### Operating temperature:

-10 °C to +50 °C

#### Storage temperature:

-25 °C to +80 °C

#### Influence of temperature:

< 0.1 % per 10 °K

#### Max. jaw opening:

90 mm

#### Max. jaw insertion capacity:

Cable: 64 mm  
Group of wires: 50 x 135 mm - 64 x 100 mm

#### Casing protection rating:

IP20 in accordance with IEC 529

#### Drop test:

500 mm (IEC 68-2-32)

#### Shock resistance:

100 g, in accordance with IEC 68-2-27

#### Vibration resistance:

10/55/10 Hz, 0.15 mm  
test in accordance with IEC 68-2-6

#### Self-extinguishing capability:

Casing: UL94 V0  
Jaws: UL94 V2

#### Dimensions:

120 x 315 x 48 mm

#### Weight:

1200 g

#### Colour:

Dark grey casing with red jaws

#### Output:

2 safety sockets (4 mm)

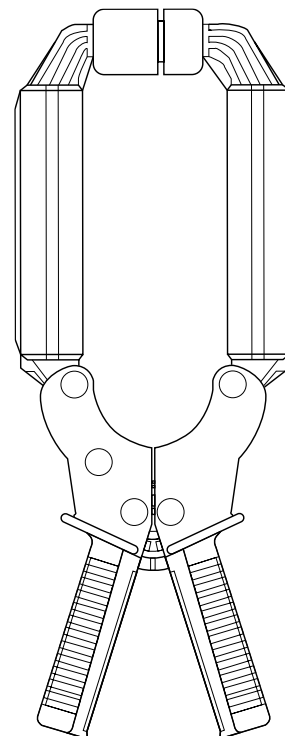

### Safety specifications

#### Electrical safety:

Double insulation or reinforced insulation between the primary and the secondary circuits and the outside casing in accordance with IEC 1010-2-032.

- 600 V category III, pollution degree 2
- 300 V category IV, pollution degree 2

#### Electromagnetic compatibility (EMC):

- EN 50081-1: class B
- EN 50082-2:
  - Electrical discharge IEC 1000-4-2
  - Radial field IEC 1000-4-3
  - Fast transients IEC 1000-4-4
  - Magnetic field at 50/60 Hz IEC 1000-4-8

(1) Conditions of reference: 23 °C ± 5 °K, 20 % to 75 % RH, 48 Hz to 65 Hz, external magnetic field < 40 A/m, no DC component, no current-carrying conductor nearby, centred test sample.

To order	Reference
AC current clamp model D31N with operating manual	P01120050A

# Current clamp for AC current

## Model D32N

DN series

<b>Current</b>	1000 A AC	2000 A AC	2400 A AC
<b>Ratio</b>	1000:1	2000:1	3000:1
<b>Output</b>	1 mA/A	0.5 mA/A	0.333 mA/A

### Electrical specifications

#### Current calibres:

1 A AC ... 1000 A AC  
1 A AC ... 2000 A AC  
1 A AC ... 2400 A AC

#### Current transformation ratio:

1000:1, 2000:1, 3000:1

#### Output signal:

1 mA/A AC (1 A for 1000 A)  
0.5 mA/A AC (1 A for 2000 A)  
0.333 mA/A AC (1 A for 3000 A)

#### Accuracy and phase shift <sup>(1)</sup>:

##### 1000 A calibre

Primary current	50 A	200 A	1000 A
% Accuracy of output signal	3 %	1.5 %	1 %
Phase shift	3°	1.5°	1°

- Load impedance: 2.5 Ω
- Overload: 1400 A for 10 minutes
- Ampere second product: 25 A.s
- Accuracy: in accordance with IEC 185-26-27, 2.5 VA, class 1 from 48 Hz to 1000 Hz

##### 2000 A calibre

Primary current	100 A	400 A	2000 A
% Accuracy of output signal	1.5 %	0.75 %	0.5 %
Phase shift	1.5°	0.75°	0.5°

- Load impedance: 5 Ω
- Overload: 2400 A for 10 minutes
- Ampere second product: 60 A.s
- Accuracy: in accordance with IEC 185-26-27, 5 VA, class 0.5 from 48 Hz to 1000 Hz

##### 3000 A calibre

Primary current	150 A	600 A	3000 A
% Accuracy of output signal	1.5 %	0.75 %	0.5 %
Phase shift	1.5°	0.75°	0.5°

- Load impedance: 10 Ω
- Overload: 3400 A for 10 minutes
- Ampere second product: 90 A.s
- Accuracy: in accordance with IEC 185-26-27, 10 VA class 0.5 from 48 Hz to 1000 Hz

#### Bandwidth:

30 Hz to 1000 Hz (in continuous use above 600 Hz the max. measurement current is limited)

#### Load impedance:

< 10 Ω max

#### Operating voltage:

600 V AC

#### Common mode voltage:

600 V AC

#### Max. voltage at output (secondary circuit open):

Electronic protection limiting the voltage to 42 V peak max.

#### Influence of adjacent conductor:

0.005 A/A AC

#### Influence of conductor position in jaws:

1.5 % ± 0.2 A on the 1000:1 ratio  
1 % ± 0.2 A on the 2000:1 ratio  
1 % ± 0.2 A on the 3000:1 ratio

### Mechanical specifications

#### Operating temperature:

-10 °C to +50 °C

#### Storage temperature:

-25 °C to +80 °C

#### Influence of temperature:

< 0.1 % per 10 °K

#### Max. jaw opening:

90 mm

#### Max. jaw insertion capacity:

Cable: 64 mm  
Group of wires: 50 x 135 mm - 64 x 100 mm

#### Casing protection rating:

IP20 in accordance with IEC 529

#### Drop test:

500 mm (IEC 68-2-32)

#### Shock resistance:

100 g, in accordance with IEC 68-2-27

#### Vibration resistance:

10/55/10 Hz, 0.15 mm  
test in accordance with IEC 68-2-6

#### Self-extinguishing capability:

Casing: UL94 V0  
Jaws: UL94 V2

#### Dimensions:

120 x 315 x 48 mm

#### Weight:

1200 g

#### Colour:

Dark grey casing with red jaws

#### Output:

2 safety sockets (4 mm)

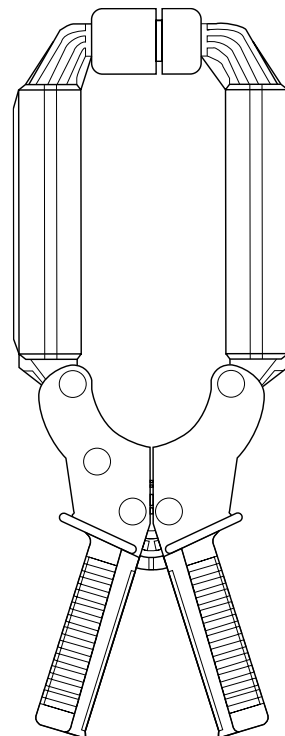

### Safety specifications

#### Electrical safety:

Double insulation or reinforced insulation between the primary and the secondary circuits and the outside casing in accordance with IEC 1010-2-032.  
- 600 V category III, pollution degree 2  
- 300 V category IV, pollution degree 2

#### Electromagnetic compatibility (EMC):

EN 50081-1: class B  
EN 50082-2:  
- Electrical discharge IEC 1000-4-2  
- Radial field IEC 1000-4-3  
- Fast transients IEC 1000-4-4  
- Magnetic field at 50/60 Hz IEC 1000-4-8

(1) Conditions of reference: 23 °C ± 5 °K, 20 % to 75 % RH, 48 Hz to 65 Hz, external magnetic field < 40 A/m, no DC component, no current-carrying conductor nearby, centred test sample.

To order	Reference
AC current clamp model D32N with operating manual	P01120051A

# Current clamp for AC current

## Model D33N

DN series

Current	2400 A AC
Ratio	3000:5
Output	1.666 mA/A

### ■ Electrical specifications

**Current calibre:**

1 A AC ...2400 A AC  
(3000 A for temperature < 35 °C)

**Current transformation ratio:**  
3000:5

**Output signal:**

1.666 mA/A AC (5 A for 3000 A)

**Accuracy and phase shift <sup>(1)</sup>:**

Primary current	150 A	600 A	3000 A
Accuracy in % of output signal	3 %	1.5 %	1 %
Phase shift	3°	1.5°	1°

**Overload:**

3600 A for 10 minutes

**Accuracy:**

In accordance with IEC 185-26-27, 5 VA class 1 from 48 Hz to 1000 Hz

**Bandwidth:**

30 Hz to 5 kHz (in continuous use above 1 kHz, the max. measurement current is limited)

**Ampere second product:**

90 A.s

**Load impedance:**

< 1 Ω

**Operating voltage:**

600 V AC

**Common mode voltage:**

600 V AC

**Influence of adjacent conductor:**

0.005 A/A AC

**Influence of conductor position in jaws:**

1 % ± 0.1 A

### ■ Mechanical specifications

**Operating temperature:**

-10 °C to +50 °C

**Storage temperature:**

-25 °C to +80 °C

**Influence of temperature:**

< 0.1 % per 10 °K

**Max. jaw opening:**

90 mm

**Max. jaw insertion capacity:**

Cable: 64 mm

Group of wires: 50 x 135 mm - 64 x 100 mm

**Casing protection rating:**

IP20 in accordance with IEC 529

**Drop test:**

500 mm (IEC 68-2-32)

**Shock resistance:**

100 g, in accordance with IEC 68-2-27

**Vibration resistance:**

10/55/10 Hz, 0.15 mm test in accordance with IEC 68-2-6

**Self-extinguishing capability:**

Casing: UL94 V0

Jaws: UL94 V2

**Dimensions:**

120 x 315 x 48 mm

**Weight:**

1200 g

**Colour:**

Dark grey casing with red jaws

**Output:**

2 safety sockets (4 mm)

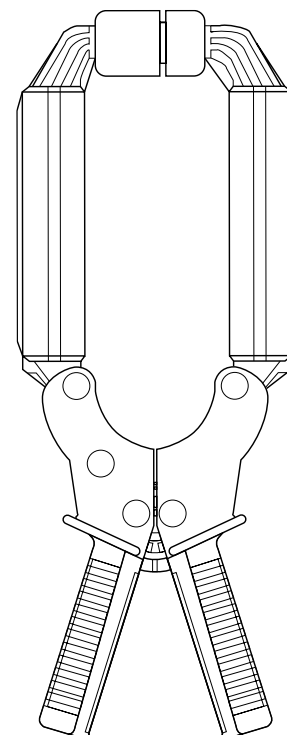

### ■ Safety specifications

**Electrical safety:**

Double insulation or reinforced insulation between the primary and the secondary circuits and the outside casing in accordance with IEC 1010-2-032.

- 600 V category III, pollution degree 2
- 300 V category IV, pollution degree 2

**Electromagnetic compatibility (EMC):**

EN 50081-1: class B

EN 50082-2:

- Electrical discharge IEC 1000-4-2
- Radial field IEC 1000-4-3
- Fast transients IEC 1000-4-4
- Magnetic field at 50/60 Hz IEC 1000-4-8

(1) Conditions of reference: 23 °C ± 5 °K, 20 % to 75 % RH, 48 Hz to 65 Hz, external magnetic field < 40 A/m, no DC component, no current-carrying conductor nearby, centred test sample, load impedance 0.2 Ω.

To order	Reference
AC current clamp model D33N with operating manual	P01120052A

# Current clamp for AC current

## Model D34N

DN series

<b>Current</b>	500 A AC	1000 A AC	1500 A AC
<b>Ratio</b>	500:5	1000:5	1500:5
<b>Output</b>	10 mA/A	5 mA/A	3.33 mA/A

### Electrical specifications

#### Current calibres:

1 A AC ... 500 A AC  
1 A AC ... 1000 A AC  
1 A AC ... 1500 A AC

#### Current transformation ratio:

500:5, 1000:5, 1500:5

#### Output signal:

10 mA/A AC (5 A for 500 A)  
5 mA/A AC (5 A for 1000 A)  
3.33 mA/A AC (5 A for 1500 A)

#### Accuracy and phase shift <sup>(1)</sup>:

##### 500 A calibre

Primary current	25 A	100 A	500 A
Accuracy in % of output signal	5 %	3 %	3 %
Phase shift	6°	4°	4°

- Load impedance: 0.2 Ω
- Overload: 700 A for 10 minutes
- Ampere second product: 3.5 A.s
- Accuracy: in accordance with IEC 185-26-27, 5 VA class 3 from 48 Hz to 1000 Hz

##### 1000 A calibre

Primary current	50 A	200 A	1000 A
Accuracy in % of output signal	3 %	1.5 %	1 %
Phase shift	3°	1.5°	1°

- Load impedance: 0.1 Ω
- Overload: 1400 A for 10 minutes
- Ampere second product: 18 A.s
- Accuracy: in accordance with IEC 185-26-27, 2.5 VA class 1 from 48 Hz to 1000 Hz

##### 1500 A calibre

Primary current	75 A	300 A	1500 A
Accuracy in % of output signal	1.5 %	0.75 %	0.5 %
Phase shift	1.5°	0.75°	0.5°

- Load impedance: 0.1 Ω
- Overload: 1800 A for 10 minutes
- Ampere second product: 40 A.s
- Accuracy: in accordance with IEC 185-26-27, 2.5 VA class 0.5 from 48 Hz to 1000 Hz

#### Bandwidth:

30 Hz to 1500 Hz (in continuous use above 1.5 kHz the max. measurement current is limited)

#### Load impedance:

< 1 Ω max

#### Operating voltage:

600 V AC

#### Common mode voltage:

600 V AC

#### Max. voltage at output (secondary circuit open):

Electronic protection limiting the voltage to 42 V peak max.

#### Influence of adjacent conductor:

0.005 A/A AC

#### Influence of conductor position in jaws:

1.5 % ± 0.2 A on the 500:5 ratio  
1 % ± 0.2 A on the 1000:5 ratio  
1 % ± 0.2 A on the 1500:5 ratio

### Mechanical specifications

#### Operating temperature:

-10 °C to +50 °C

#### Storage temperature:

-25 °C to +80 °C

#### Influence of temperature:

< 0.1 % per 10 °K

#### Max. jaw opening:

90 mm

#### Max. jaw insertion capacity:

Cable: 64 mm  
Group of wires: 50 x 135 mm - 64 x 100 mm

#### Casing protection rating:

IP20 in accordance with IEC 529

#### Drop test:

500 mm (IEC 68-2-32)

#### Shock resistance:

100 g, in accordance with IEC 68-2-27

#### Vibration resistance:

10/55/10 Hz, 0.15 mm  
test in accordance with IEC 68-2-6

#### Self-extinguishing capability:

Casing: UL94 V0  
Jaws: UL94 V2

#### Dimensions:

120 x 315 x 48 mm

#### Weight:

1200 g

#### Colour:

Dark grey casing with red jaws

#### Output:

2 safety sockets (4 mm)

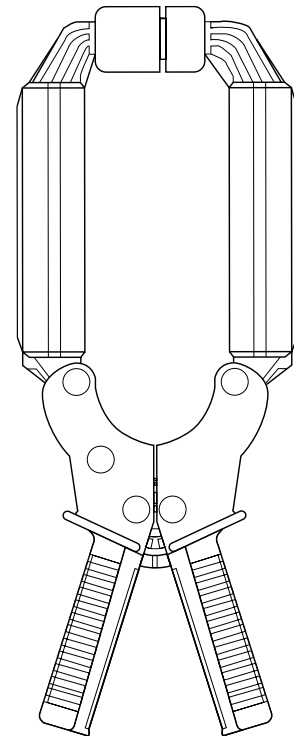

### Safety specifications

#### Electrical safety:

Double insulation or reinforced insulation between the primary and the secondary circuits and the outside casing in accordance with IEC 1010-2-032.

- 600 V category III, pollution degree 2
- 300 V category IV, pollution degree 2

#### Electromagnetic compatibility (EMC):

EN 50081-1: class B

EN 50082-2:

- Electrical discharge IEC 1000-4-2
- Radial field IEC 1000-4-3
- Fast transients IEC 1000-4-4
- Magnetic field at 50/60 Hz IEC 1000-4-8

(1) Conditions of reference: 23 °C ± 5 °K, 20 % to 75 % RH, 48 Hz to 65 Hz, external magnetic field < 40 A/m, no DC component, no current-carrying conductor nearby, centred test sample.

<b>To order</b>	<b>Reference</b>
AC current clamp model <b>D34N</b> with operating manual	P01120053A

# Current clamp for AC current

## Model D35N

DN series

<b>Current</b>	1000 A AC	2000 A AC	2400 A AC
<b>Ratio</b>	1000:5	2000:5	3000:5
<b>Output</b>	5 mA/A	2.5 mA/A	1.666 mA/A

### Electrical specifications

#### Current calibres:

- 1 A AC ... 1000 A AC
- 1 A AC ... 2000 A AC
- 1 A AC ... 2400 A AC  
(3000 A for temperature < 35 °C)

#### Current transformation ratio:

1000:5, 2000:5, 3000:5

#### Output signal:

- 5 mA/A AC (5 A for 1000 A)
- 2.5 mA/A AC (5 A for 2000 A)
- 1.666 mA/A AC (5 A for 3000 A)

#### Accuracy and phase shift <sup>(1)</sup>:

##### ■ 1000 A calibre

Primary current	50 A	200 A	1000 A
% Accuracy of output signal	3 %	1.5 %	1 %
Phase shift	3°	1.5°	1°

- Load impedance: 0.1 Ω
- Overload: 1200 A for 10 minutes
- Ampere second product: 15 A.s
- Accuracy:  
in accordance with IEC 185-26-27,  
2.5 VA, class 1 from 48 Hz to 1000 Hz

##### ■ 2000 A calibre

Primary current	100 A	400 A	2000 A
% Accuracy of output signal	1.5 %	0.75 %	0.5 %
Phase shift	1.5°	0.75°	0.5°

- Load impedance: 0.2 Ω
- Overload: 2400 A for 10 minutes
- Ampere second product: 50 A.s
- Accuracy:  
in accordance with IEC 185-26-27, 5 VA,  
class 0.5 from 48 Hz to 1000 Hz

##### ■ 3000 A calibre

Primary current	150 A	600 A	3000 A
% Accuracy of output signal	1.5 %	0.75 %	0.5 %
Phase shift	1.5°	0.75°	0.5°

- Load impedance: 0.4 Ω
- Overload: 2400 A for 10 minutes
- Ampere second product: 80 A.s
- Accuracy:  
in accordance with IEC 185-26-27, 10 VA  
class 0.5 from 48 Hz to 1000 Hz

#### Bandwidth:

30 Hz to 1500 Hz (in continuous use above 1.5 kHz, the max. measurement current is limited)

#### Load impedance:

< 2 Ω max

#### Operating voltage:

600 V AC

#### Common mode voltage:

600 V AC

#### Influence of adjacent conductor:

0.005 A/A AC

#### Influence of conductor position in jaws:

- 1.5 % ± 0.2 A on the 1000:5 ratio
- 1 % ± 0.2 A on the 2000:5 ratio
- 1 % ± 0.2 A on the 3000:5 ratio

### Mechanical specifications

#### Operating temperature:

-10 °C to +50 °C

#### Storage temperature:

-25 °C to +80 °C

#### Influence of temperature:

< 0.1 % per 10 °K

#### Max. jaw opening:

90 mm

#### Max. jaw insertion capacity:

- Cable: 64 mm
- Group of wires: 50 x 135 mm - 64 x 100 mm

#### Casing protection rating:

IP20 in accordance with IEC 529

#### Drop test:

500 mm (IEC 68-2-32)

#### Shock resistance:

100 g, in accordance with IEC 68-2-27

#### Vibration resistance:

10/55/10 Hz, 0.15 mm  
test in accordance with IEC 68-2-6

#### Self-extinguishing capability:

Casing: UL94 V0

Jaws: UL94 V2

#### Dimensions:

120 x 315 x 48 mm

#### Weight:

1200 g

#### Colour:

Dark grey casing with red jaws

#### Output:

Safety sockets (4 mm)

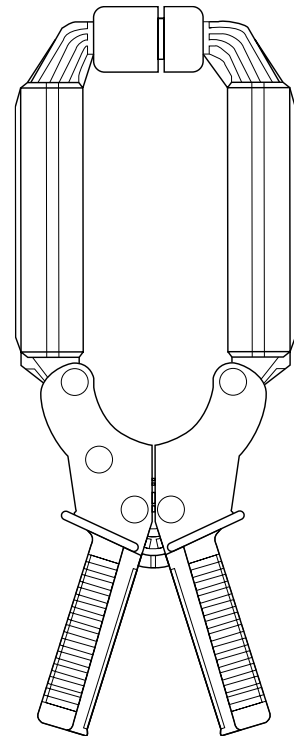

### Safety specifications

#### Electrical safety:

Double insulation or reinforced insulation between the primary and the secondary circuits and the outside casing in accordance with IEC 1010-2-032.

- 600 V category III, pollution degree 2
- 300 V category IV, pollution degree 2

#### Electromagnetic compatibility (EMC):

EN 50081-1: class B

EN 50082-2:

- Electrical discharge IEC 1000-4-2
- Radial field IEC 1000-4-3
- Fast transients IEC 1000-4-4
- Magnetic field at 50/60 Hz IEC 1000-4-8

(1) Conditions of reference: 23 °C ± 5 °K, 20 % to 75 % RH, 48 Hz to 65 Hz, external magnetic field < 40 A/m, no DC component, no current-carrying conductor nearby, centred test sample.

To order	Reference
AC current clamp model D35N with operating manual	P01120054A



# Current clamp for AC current

## Model D36N

DN series

Current	3000 A AC
Ratio	3000:3
Output	1 mA/A

### ■ Electrical specifications

**Current calibre:**

1 A AC ... 2400 A AC

**Current transformation ratio:**

3000:3

**Output signal:**

1 mA/A AC (3 A for 3000 A)

**Accuracy and phase shift <sup>(1)</sup>:**

Primary current	150 A	600 A	3000 A
% Accuracy of output signal	0.5 %	0.75 %	0.5 %
Phase shift	1.5°	0.75°	0.5°

**Accuracy:**

In accordance with IEC 185-26-27, 5 VA, class 0.5 from 48 Hz to 1000 Hz

**Bandwidth:**

30 Hz to 5 kHz

(beyond 400 Hz the output is limited in inverse proportion to the frequency)

**Overload:**

3600 A for 5 minutes

**Max. voltage output**

**(secondary circuit open):**

Electronic protection limiting the voltage to 42 V peak max.

**Load impedance:**

< 0.6 Ω

**Operating voltage:**

600 V AC

**Common mode voltage:**

600 V AC

**Influence of adjacent conductor:**

0.005 A/A AC

**Influence of conductor position in jaws:**

1 % ± 0.1 A

### ■ Mechanical specifications

**Operating temperature:**

-10 °C to +50 °C

**Storage temperature:**

-25 °C to +80 °C

**Influence of temperature:**

< 0.1 % per 10 °K

**Max. jaw opening:**

90 mm

**Max. jaw insertion capacity:**

Cable: 64 mm

Group of wires: 50 x 135 mm - 64 x 100 mm

**Casing protection rating:**

IP20 in accordance with IEC 529

**Drop test:**

500 mm (IEC 68-2-32)

**Shock resistance:**

100 g, in accordance with IEC 68-2-27

**Vibration resistance:**

10/55/10Hz, 0.15 mm

test in accordance with IEC 68-2-6

**Self-extinguishing capability:**

Casing: UL94 V0

Jaws: UL94 V2

**Dimensions:**

120 x 315 x 48 mm

**Weight:**

1200 g

**Colour:**

Dark grey casing with red jaws

**Output:**

Safety sockets (4 mm)

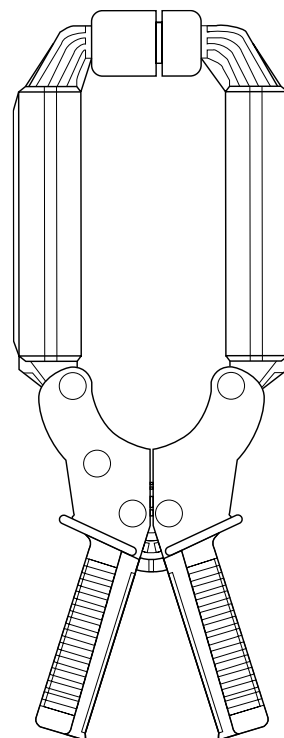

### ■ Safety specifications

**Electrical safety:**

Double insulation or reinforced insulation between the primary and the secondary circuits and the outside casing in accordance with IEC 1010-2-032.

- 600 V category III, pollution degree 2
- 300 V category IV, pollution degree 2

**Electromagnetic compatibility (EMC):**

EN 50081-1: class B

EN 50082-2:

- Electrical discharge IEC 1000-4-2
- Radial field IEC 1000-4-3
- Fast transients IEC 1000-4-4
- Magnetic field at 50/60 Hz IEC 1000-4-8

(1) Conditions of reference: 23 °C ± 5 °K, 20 % to 75 % RH, 48 Hz to 65 Hz, external magnetic field < 40 A/m, no DC component, no current-carrying conductor nearby, centred test sample, load impedance 0,55 Ω.

To order	Reference
AC current clamp model D36N with operating manual	P01120055A

# Current clamp for AC current

## Model D37N

DN series

<b>Current</b>	30 A AC	300 A AC	3000 A AC
<b>Output</b>	100 mV/A	10 mV/A	1 mV/A

### Electrical specifications

#### Current calibres:

10 mA...30 A AC  
1 A AC...300 A AC  
1 A AC...2000 A AC  
(2800 A for temperature < 35 °C)

#### Output signal:

100 mV/A AC (3 V for 30 A) 90 A peak  
10 mV/A AC (3 V for 300 A) 900 A peak  
1.666 mV/A AC (3 V for 3000 A) 9000 A peak

#### Accuracy and phase shift <sup>(1)</sup>:

##### ■ 30 A calibre

Primary current	1.5 A	6 A	30 A
% Accuracy of output signal	2 % ± 10 mV		
Phase shift	15°	7°	5°

##### ■ 300 A calibre

Primary current	15 A	60 A	300 A
% Accuracy of output signal	2 % ± 2 mV		
Phase shift	3°	1.5°	1°

##### ■ 3000 A calibre

Primary current	150 A	600 A	3000 A
% Accuracy of output signal	2 % ± 0.5 mV		
Phase shift	1.5°	1°	0.5°

#### Overload:

3200 A for 5 mn

#### Ampere second product:

100 A.s

#### dV/dt:

100 mVAC/A AC: dV/dt = 400 mV/μs  
10 mVAC/A AC: dV/dt = 50 mV/μs  
1 mVAC/A AC: dV/dt = 5 mV/μs

#### Bandwidth:

30 Hz to 5 kHz (on the 3000 A range the max. measurement current is limited above 200 Hz)

#### Load impedance:

≥ 1 MΩ

#### Operating voltage:

600 V AC

#### Common mode voltage:

600 V AC

#### Influence of adjacent conductor:

0.005 A/A AC

#### Influence of conductor position in jaws:

1.5 % of the reading

#### Influence of frequency:

30 Hz to 5 kHz:  
± 6 % on all calibres

#### Influence of DC current:

0.04 % per A DC

### Mechanical specifications

#### Operating temperature:

-10 °C to +50 °C

#### Storage temperature:

-25 °C to +80 °C

#### Influence of temperature:

< 0.1 % per 10 °K

#### Max. jaw opening:

90 mm

#### Max. jaw insertion capacity:

Cable: 64 mm  
Group of wires: 50 x 135 mm - 64 x 100 mm

#### Casing protection rating:

IP20 in accordance with IEC 529

#### Drop test:

500 mm (IEC 68-2-32)

#### Shock resistance:

100 g, in accordance with IEC 68-2-27

#### Vibration resistance:

10/55/10 Hz, 0.15 mm  
test in accordance with IEC 68-2-6

#### Self-extinguishing capability:

Casing: UL94 V0  
Jaws: UL94 V2

#### Dimensions:

120 x 315 x 48 mm

#### Weight:

1200 g

#### Colour:

Dark grey casing with red jaws

#### Output:

Safety sockets (4 mm)

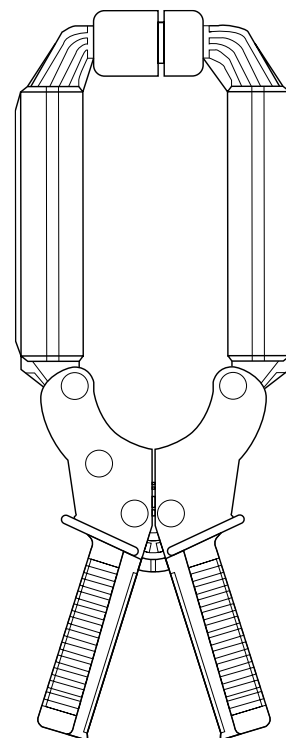

### Safety specifications

#### Electrical safety:

Double insulation or reinforced insulation between the primary and the secondary circuits and the outside casing in accordance with IEC 1010-2-032.  
- 600 V category III, pollution degree 2  
- 300 V category IV, pollution degree 2

#### Electromagnetic compatibility (EMC):

EN 50081-1: class B  
EN 50082-2:  
- Electrical discharge IEC 1000-4-2  
- Radial field IEC 1000-4-3  
- Fast transients IEC 1000-4-4  
- Magnetic field at 50/60 Hz IEC 1000-4-8

(1) Conditions of reference: 23 °C ± 5 °K, 20 % to 75 % RH, 48 Hz to 65 Hz, external magnetic field < 40 A/m, no DC component, no current-carrying conductor nearby, centred test sample.

To order	Reference
AC current clamp model <b>D37N</b> with operating manual	P01120056A

# Oscilloscope clamp for AC current

## Model D38N (insulated AC current probe)

D<sub>N</sub> series

<b>Current</b>	90 A peak	900 A peak	9000 A peak
<b>Output</b>	10 mV/A	1 mV/A	0.1 mV/A

### Description

The D38N offers accurate AC current measurement and a voltage output in mV allowing direct readings on oscilloscopes. A switch with 3 positions on the handle can be used to select the ranges. The wide opening of the jaws means they can be used on cables and small busbars.

### Electrical specifications

#### Current calibres:

1 A AC ... 30 A AC (90 A peak)  
 1 A AC ... 300 A AC (900 A peak)  
 1 A AC ... 2400 A AC (9000 A peak)  
 (3000 A for temperature < 35 °C)

#### Output signal:

10 mV/A AC (3 V for 30 A)  
 1 mV/A AC (3 V for 300 A)  
 0.1 mV/A AC (3 V for 3000 A)

#### Accuracy and phase shift <sup>(1)</sup>:

##### ■ 30 A calibre

Primary current	1.5 A	6 A	30 A	36 A
% Accuracy of output signal	2 % ± 1 mV			
Phase shift	≤ 20°	≤ 10°	≤ 5°	≤ 5°

##### ■ 300 A calibre

Primary current	15 A	60 A	300 A	360 A
% Accuracy of output signal	2 % ± 0.5 mV			
Phase shift	≤ 3°	≤ 1.5°	≤ 1°	≤ 1°

##### ■ 3000 A calibre

Primary current	150 A	600 A	3000 A	3600 A
% Accuracy of output signal	2 % ± 0.2 mV			
Phase shift	≤ 3°	≤ 1.5°	≤ 1°	≤ 1°

#### Bandwidth:

10 Hz to 50 kHz (depending on current)

#### Rise/fall time from 10 % to 90 %:

4 μs

#### 10 % delay time:

0.3 μs

#### Ampere second product:

- 30 A calibre: 30 A.s
- 300 A calibre: 125 A.s
- 3000 A calibre: 180 A.s

#### Insertion impedance (at 400 Hz / 10 kHz):

- 30 A calibre: < 0.1 mΩ / < 1 mΩ
- 300 A calibre: < 0.1 mΩ / < 0.5 mΩ
- 3000 A calibre: < 0.1 mΩ / < 0.4 mΩ

#### Maximum currents:

I < 2400 A permanent  
 2400 A ... 2800 A for 10 minutes and then 30 minutes shutdown  
 2800 A ... 4000 A for 5 minutes and then 30 minutes shutdown

#### Output impedance:

- 30 A calibre: ≤ 130 Ω ± 15 %
- 300 A calibre: ≤ 140 Ω ± 15 %
- 3000 A calibre: ≤ 140 Ω ± 15 %

#### Influence of temperature:

≤ 0.2 % of output signal per 10 °K

#### Influence of adjacent conductor:

≤ 5 mA/A at 50 Hz

#### Influence of DC current < 10 % of rated calibre superimposed on the rated current:

0.05 % / A DC

#### Influence of conductor position in jaws:

≤ 1 % + 0.1 A at 50/60 Hz

#### Influence of frequency <sup>(2)</sup>:

- 30 A calibre: < 1 dB from 10 Hz...10 kHz
- 300 A calibre: < 1 dB from 10 Hz...10 kHz
- 3000 A calibre: < 1 dB from 10 Hz...10 kHz

### Mechanical specifications

#### Max. jaw opening:

90 mm

#### Clamping capacity:

Cable: Ø max 64 mm  
 Group of busbars:  
 5 busbars of 125 x 5 mm  
 3 busbars of 100 x 10 mm  
 (busbars spaced by their thickness)

#### Output:

2 m coaxial lead with insulated BNC plug

#### Dimensions:

310 x 120 x 48 mm

#### Weight:

1200 g

#### Operating temperature:

-10 °C to +50 °C

#### Storage temperature:

-25 °C to +80 °C

#### Relative humidity for operation:

0 to 85 % RH with a linear decrease above 35 °C

#### Operating altitude:

0 to 2,000 m

#### Casing protection rating:

IP 20 (IEC 529)

#### Drop test:

0.5 m (IEC 68-2-32)

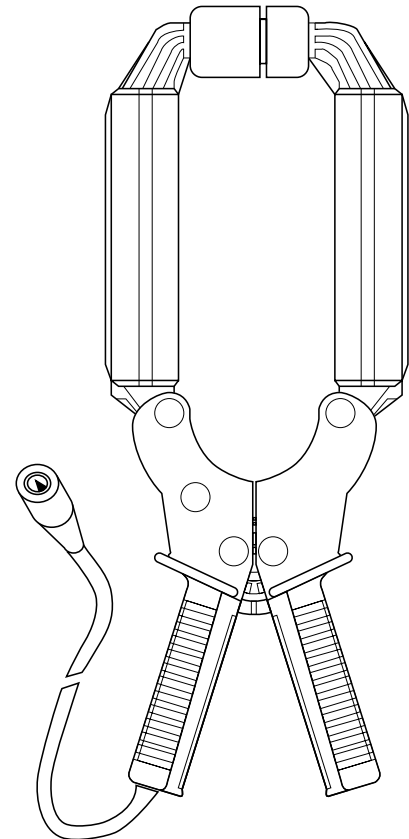

#### Shock resistance:

100 g / 6 ms / half-period (IEC 68-2-27)

#### Protection against impacts:

IK04 0.5 J (EN 50102)

#### Vibration resistance:

10/55/10 Hz, 0.15 mm (IEC 68-2-6)

#### Self-extinguishing capability:

Handles: UL94 V0

Jaws: UL94 V2

#### Colours:

Dark grey handles with red jaws

### Safety specifications

#### Electrical safety:

Instrument with double insulation or reinforced insulation between the primary, the secondary and the grippable part located under the guard as per IEC 1010-1 & IEC 1010-2-032

- 600 V category III, pollution degree 2

- 300 V category IV, pollution degree 2

# Oscilloscope clamp for AC current Model D38N (insulated AC current probe)

*D<sub>N</sub> series*

## ■ Curves at 50 Hz

### 30 A calibre

Error on measurement

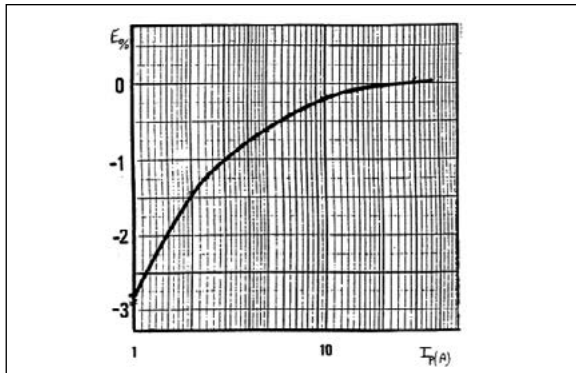

Phase shift

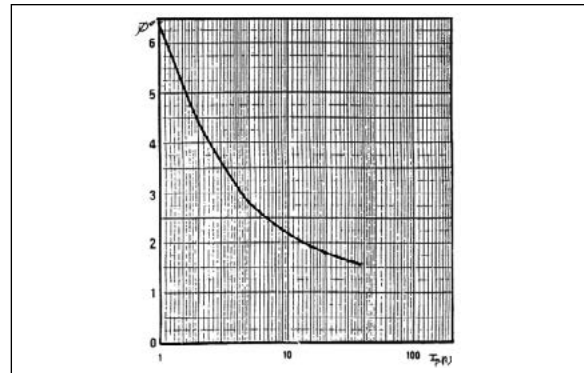

### 300 A calibre

Error on measurement

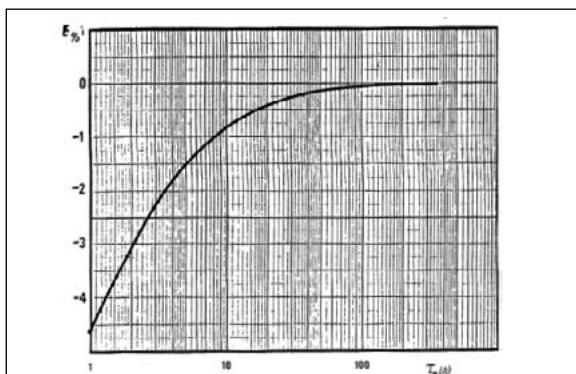

Phase shift

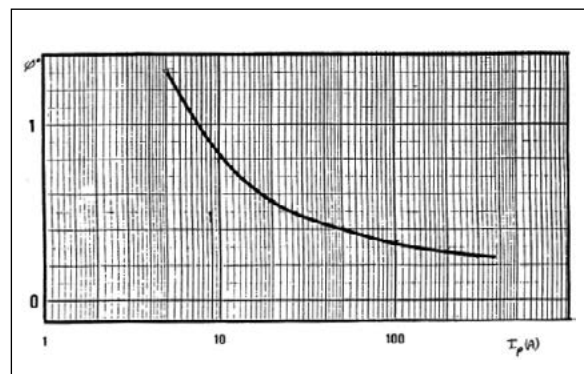

### 3000 A calibre

Error on measurement

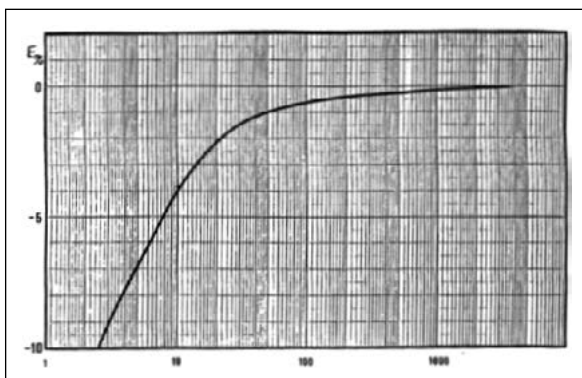

Phase shift

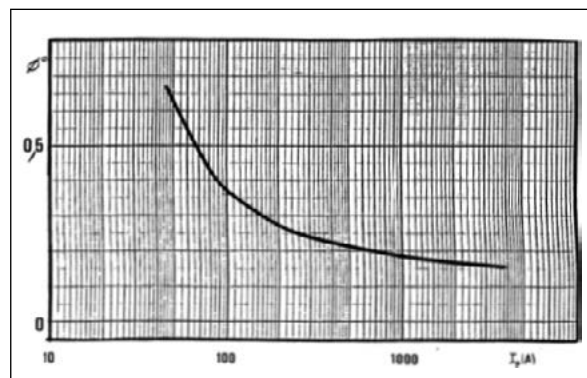

# Oscilloscope clamp for AC current

## Model D38N (insulated AC current probe)

*D<sub>N</sub> series*

### ■ Frequency response

30 A calibre

I = 10 A

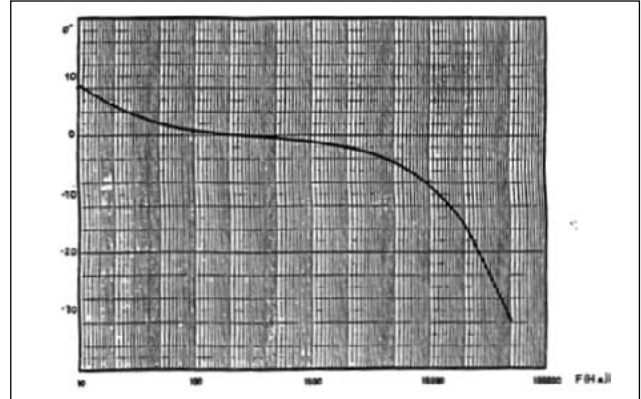
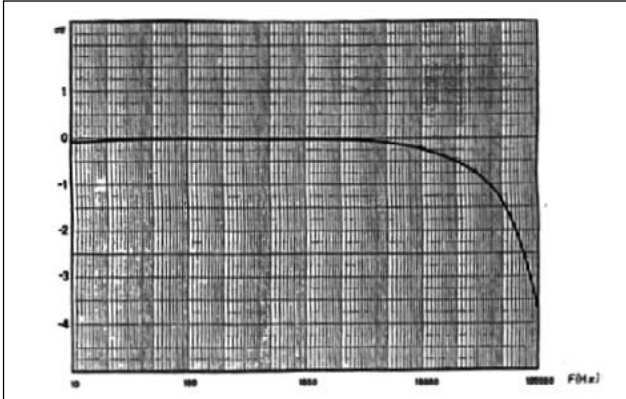

300 A calibre

I = 10 A

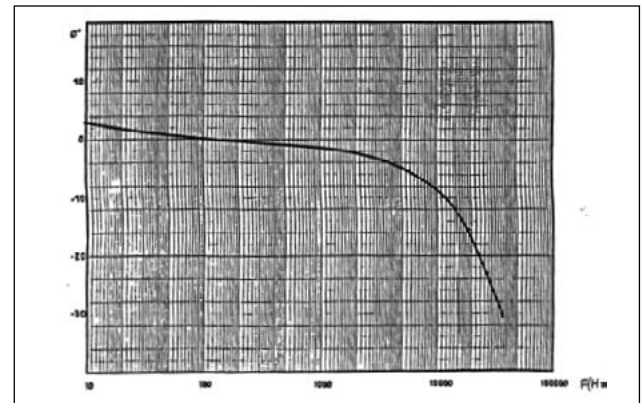
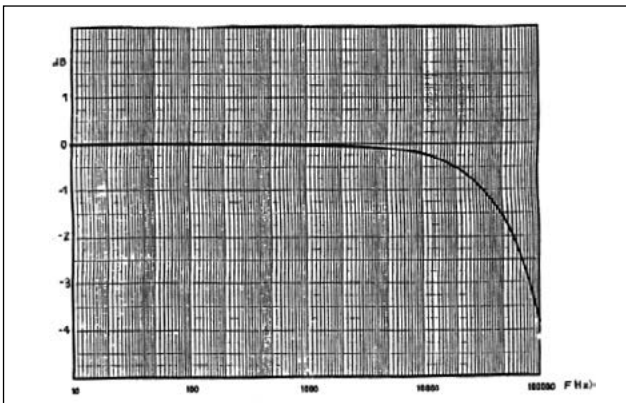

3000 A calibre

I = 100 A

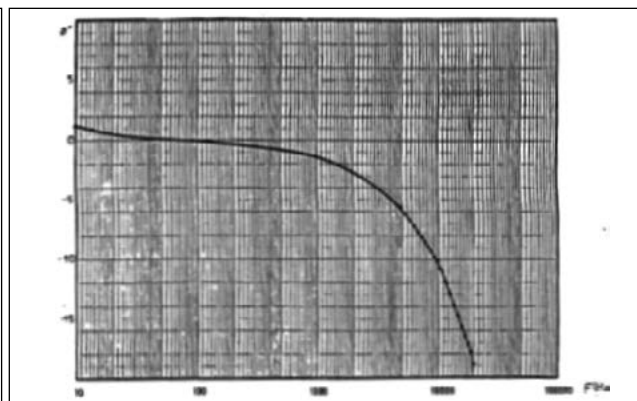
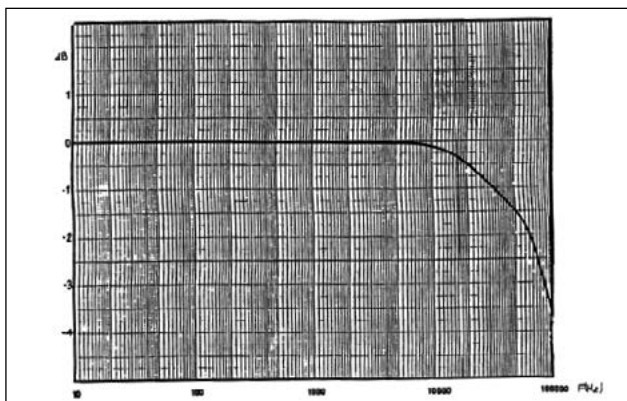

# Oscilloscope clamp for AC current Model D38N (insulated AC current probe)

## ■ Response to a step ( $I_p = 1$ A)

*30 A calibre*

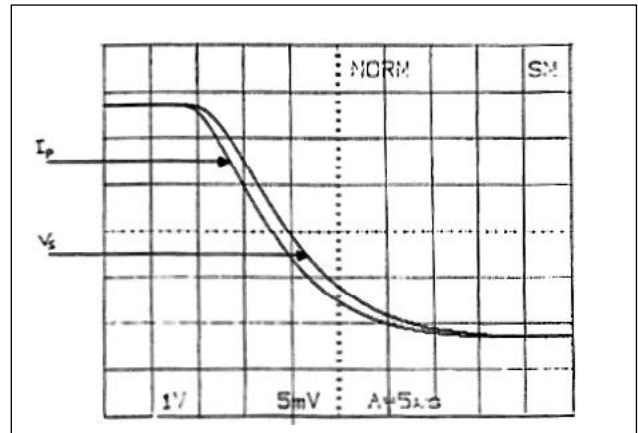
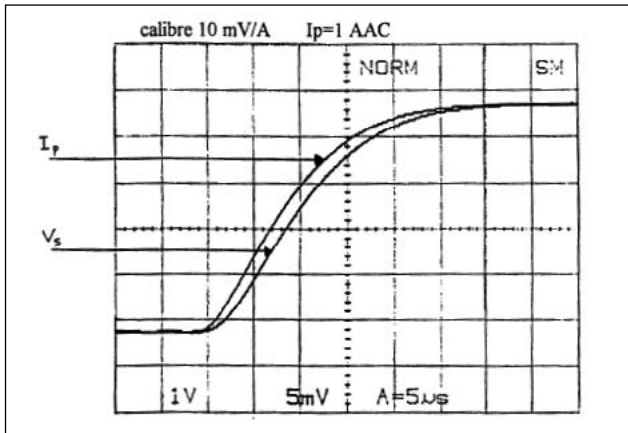

## ■ Response to a square signal ( $I_p = 10$ A)

*30 A calibre*

10 Hz

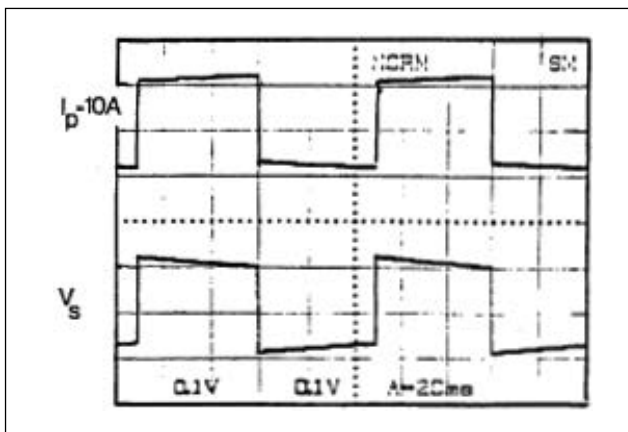

100 Hz

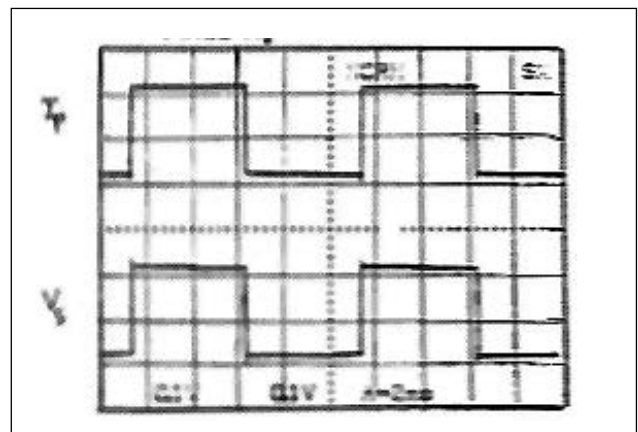

1 kHz

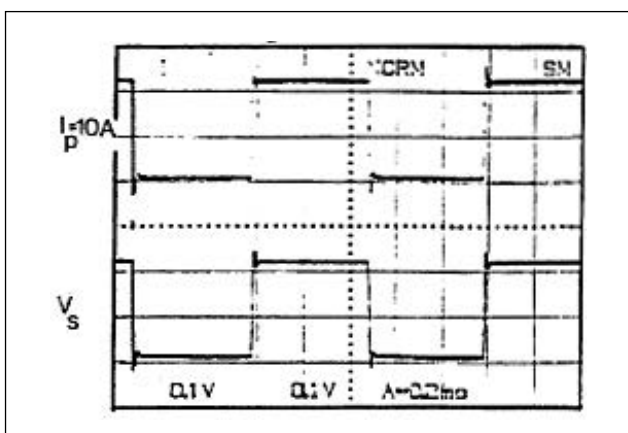

10 kHz

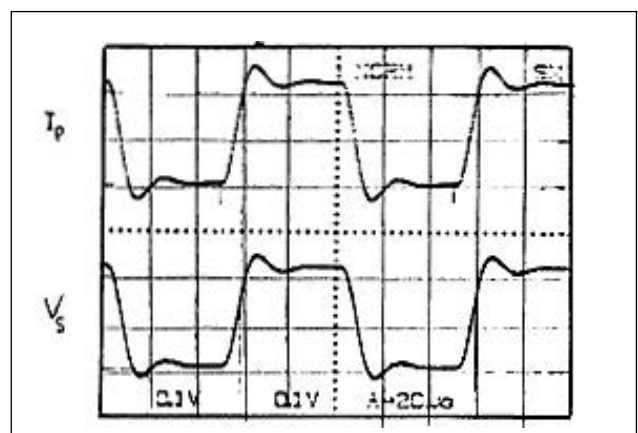

# Oscilloscope clamp for AC current

## Model D38N (insulated AC current probe)

*D<sub>N</sub> series*

### ■ Influence of a DC current superimposed on the signal

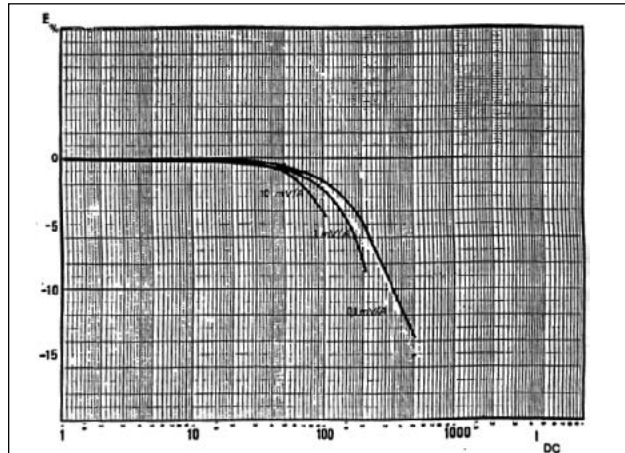

### ■ Maximum current according to the frequency

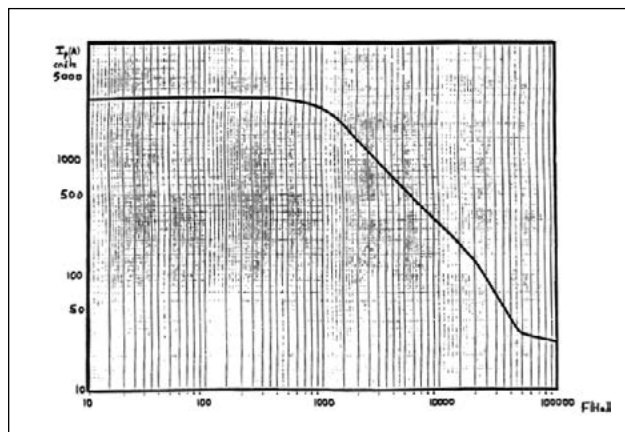

(1) Conditions of reference: 23 °C ± 3 °K, 20 % to 75 % RH, sinusoidal signal with frequency of 48 Hz at 65 Hz, external magnetic field < 40 A/m, no DC components, no external conductor with circulating current, conductor centred for measurement, load impedance >1 MΩ / < 47 pF.

(2) Out of reference domain.

To order	Reference
AC current clamp model <b>D38N</b> for oscilloscope, with operating manual	P01120057A



## B series

The only model in the B series, the B102 is designed to measure earth leakage currents caused by insulation faults. It enables the fault to be located and diagnosed before failure occurs thus avoiding installation shutdown.

It is designed specifically for locating low-current faults on high-current circuits.

The B102 measures differential or leakage current from 500  $\mu$ A upwards and may be used to measure currents up to 400 A in continuous use (400 A max.).

The B102 has two measurement ranges, 1 mV/mA or 1 mV/A.

As a leakage current detector, the B102 can be used on single or multiphase systems whether the currents are in or out of phase, balanced or unbalanced.

The B02 may be used simply as a high-precision clamp-on current probe.

With its 115 mm jaw opening and dynamic measurement range from 500  $\mu$ A to 400 A, the B102 is a versatile instrument, highly useful in the analysis of unbalanced circuits, leakage currents and earth loop currents.

When operated in conjunction with an artificial neutral, the B102 can also be used to measure fault currents on 3-phase circuits with no neutral.

(1) AN1 artificial neutral box (see chapter 12)



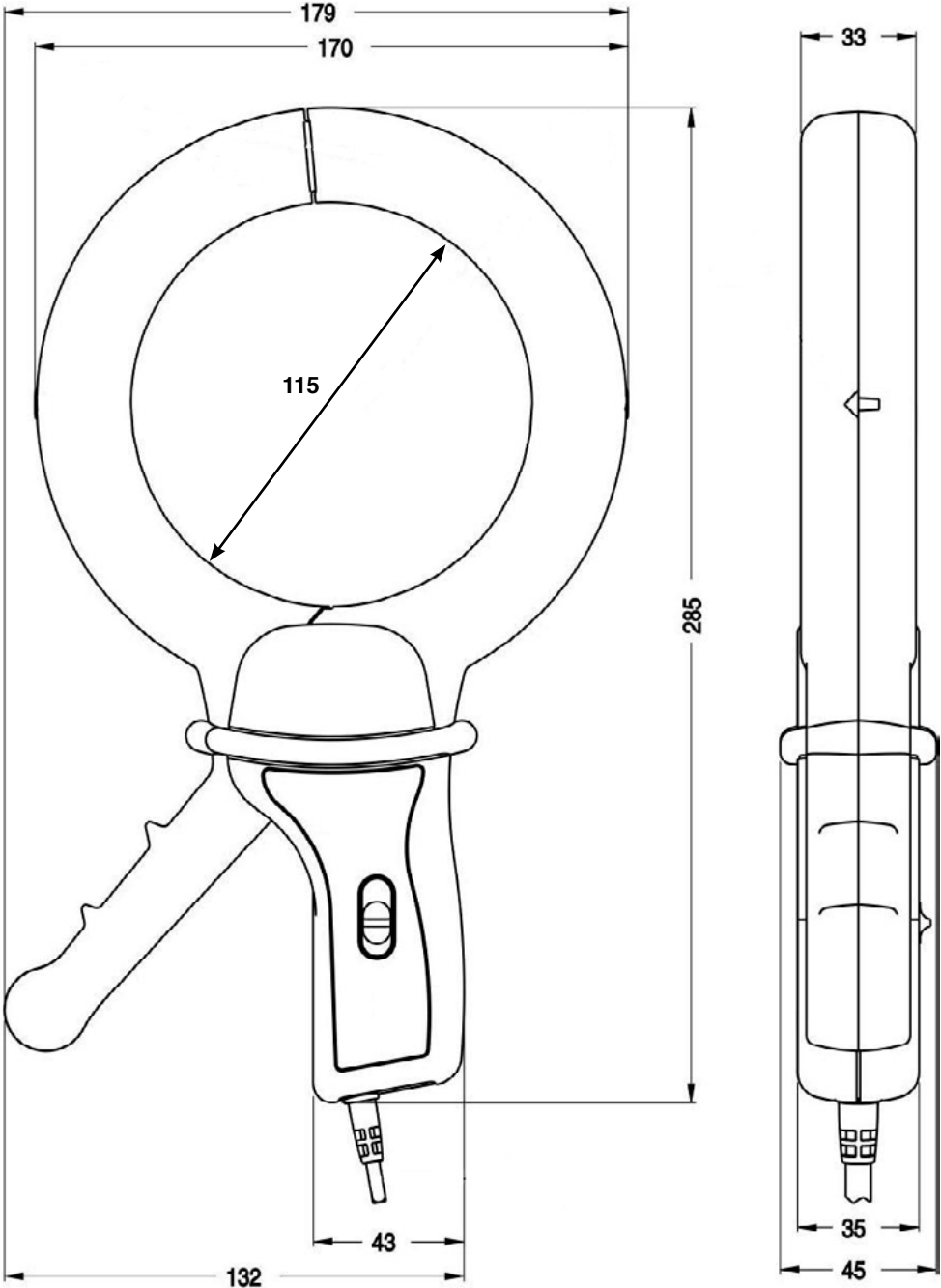

# Current clamp for AC current

## Model B102 (clamp for leakage currents)

B100 series

Current	4 A AC	400 A AC
Output	1 mV/mA	1 mV/A

### Description

The B102 clamp measures leakage currents or residual currents as low as 500  $\mu$ A and can be used with multimeters equipped with a calibre in mV AC.

The B102 clamp measures the currents flowing in earth loops as well as leakage currents. It can be used on live installations to detect insulation faults on the earth circuits of single and three-phase networks.

For three-wire three-phase systems, use the artificial neutral box.

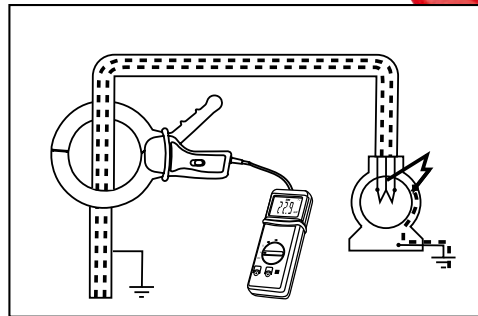

### Electrical specifications

#### Current calibres:

0.5 mA AC...4 A AC  
0.5 A AC ...400 A AC

#### Output signal:

1 mV AC / mA AC (4 V for 4 A)  
1 mV AC / A AC (0.4 V for 400 A)

#### Accuracy and phase shift <sup>(1)</sup>:

Calibre	4 A		
Primary current	0.5 mA...10 mA	10 mA...100 mA	100 mA...4 A
Accuracy in % of output signal	$\leq 3\% + 1\text{ mV}$	$\leq 0.5\% + 0.5\text{ mV}$	$\leq 0.5\% + 0.5\text{ mV}$
Phase shift	not specified	$\leq 15^\circ$	$\leq 10^\circ$

Calibre	400 A		
Primary current	0.5 mA...10 mA	10 A...200 A	200 A...400 A
Accuracy in % of output signal	$\leq 0.5\% + 0.5\text{ mV}$	$\leq 0.35\% + 0.5\text{ mV}$	$\leq 0.35\% + 0.5\text{ mV}$
Phase shift	not specified	$\leq 1^\circ$	$\leq 0.7^\circ$

#### Bandwidth:

30 kHz ...1 kHz (depending on current value)

#### Maximum currents:

400 A AC continuous for a frequency  $\leq 1$  kHz:  
Peak current < 1000 A

#### Max. voltage output:

Electronic protection limiting the voltage to 6 V peak max.

#### Influence of temperature:

Measurement:  $\leq 100$  ppm/K or 0.1 % of output signal per 10 °K

#### Influence of adjacent conductor:

0.4 mA/A typical at 50 Hz

#### Influence of an external field:

- 4 A calibre:  $\leq 60$  mA
- 400 A calibre:  $\leq 0.1$  A
- for 400 A/m calibre at 50 Hz

#### Influence of conductor position in jaws:

$\leq 0.1$  % of the reading at 50/60 Hz (non-residual current)  
 $\leq 0.2$  % of the reading at 50/60 Hz (residual current)

#### Influence of a DC current superimposed on the rated AC current:

- 4 A calibre:  $\leq 1$  mA
- 400 A calibre:  $\leq 0.1$  A for a current DC of 1 A

#### Influence of frequency:

- 4 A calibre:  $\leq 2\%$
- 400 A calibre:  $\leq 0.5\%$  from 30 Hz to 1 kHz (limited to 100 A for 1 kHz)

#### Influence of the measurement instrument's input impedance:

- 4 A calibre:  
 $E\% = [Ze/(Ze + 4.8) - 1] * 100$
- 400 A calibre:  
 $E\% = [Ze/(Ze + 0.0048) - 1] * 100$

### Mechanical specifications

#### Operating temperature:

-10 °C to +55 °C

#### Storage temperature:

-40 °C to +70 °C

#### Max. jaw insertion capacity:

Cables:  $\varnothing$  115 mm  
Bars: 1 busbar 20 x 50 mm

#### Casing protection rating:

IP 40 with clamp closed (NF EN 60529 Ed. 95)  
IP 30 with jaws open

#### Relative humidity for operation:

0 to 85 % RH with a linear decrease above 35°C

#### Operating altitude:

0 to 2,000 m

#### Drop test:

1 m (NF EN 61010-2-032)

#### Self-extinguishing capability:

Casing: V0 according to UL94  
Jaws: V2 according to UL94

#### Dimensions:

285 x 175 x 43 mm

#### Weight:

1.3 kg approx.

#### Colours:

Casing: dark grey  
Jaws: red

#### Output:

Cable with double insulation, length 1.5 m, terminated by 2 insulated elbowed male  $\varnothing$  4 mm banana plugs

### Safety specifications

#### Electrical safety:

Instrument with double insulation or reinforced insulation between the primary, the secondary and the grippable part located under the guard as per EN 61010-1 Ed. 2: 2001, EN 61010-2-031 Ed. 2002 & EN 61010-2-032 Ed. 2003

- 600 V category III, pollution degree 2
- 300 V category IV, pollution degree 2

#### Electromagnetic compatibility:

CE-certified equipment compliant with standard EN 61326-1 (Ed. 97) + A1 (Ed. 98) + A2 (Ed. 01)  
- Emission: regulations for class B equipment (domestic use)  
- Immunity: regulations for equipment operated intermittently on industrial sites

# Current clamp for AC current

## Model B102 (clamp for leakage currents)

B100 series

### Curves at 50 Hz

4 A calibre

400 A calibre

Linearity for AC

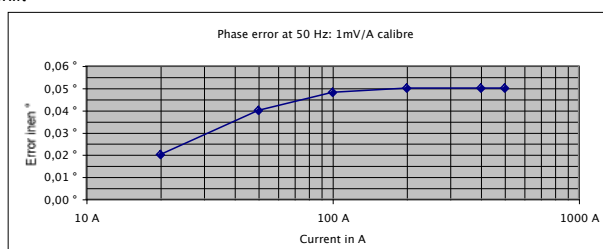
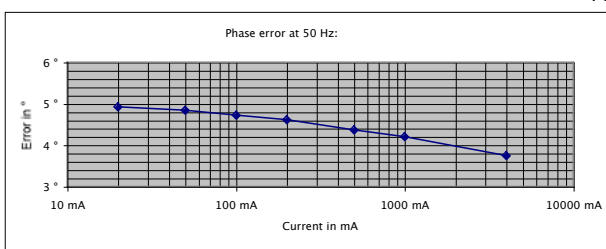
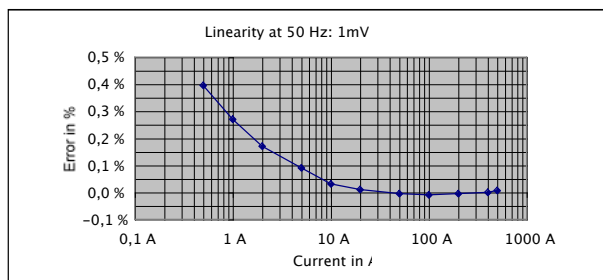
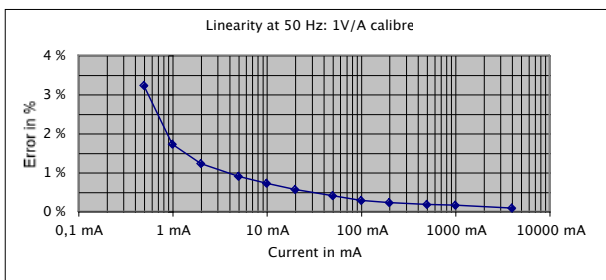

### Frequency response

4 A calibre

400 A calibre

Typical error on measurement

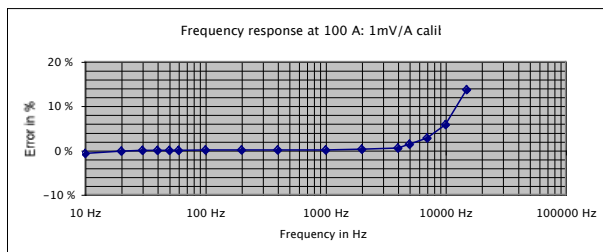
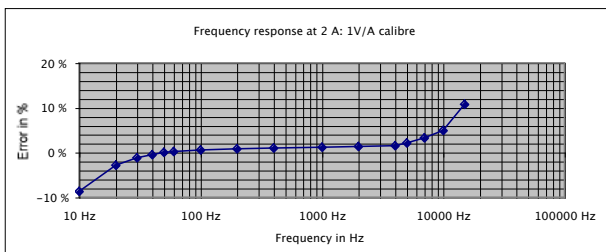

Phase shift typical

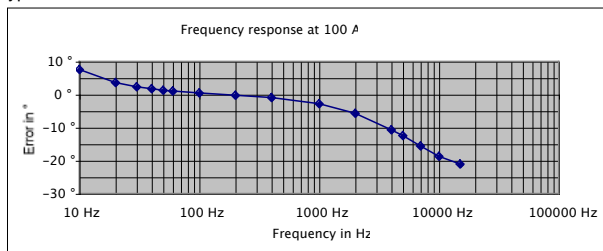
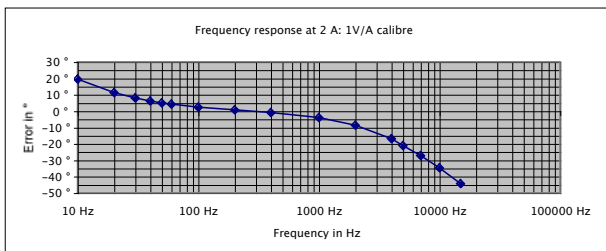

(1) Conditions of reference: 23 °C ± 3 °K, 20 % to 75 % RH, sinusoidal signal with frequency of 48 to 65 Hz, distortion factor < 1 %, no DC components, external magnetic field < 40 A/m, no AC magnetic field, no external conductor with current flowing, conductor centred for measurement, load impedance ≥ 10 MΩ / ≤ 100 pF.

To order	Reference
AC current clamp model <b>B102</b> with operating manual	P01120033
Accessories: <b>AN1</b> artificial neutral box (see chapter 12)	P01197201
<b>Bag No. 11</b>	P01100120



## MiniFLEX series

Making use of the principle of Rogowski coils, the MiniFLEX models are flexible sensors offering a wide dynamic range for measuring AC currents and viewing high-speed current pulses.

The sensor's output voltage is proportional to the derivative of the current measured in the conductor and requires an electronic system for formatting.

The absence of a magnetic core at the centre of the coil brings several advantages:

- flexibility and light weight
- excellent response to rapid current changes, as it is not possible for induced Fourier currents to occur, so they do not increase the sensor's response time.
- excellent linearity due to the absence of core saturation even when there are very high current, as in the case of electric power transmission, electrical welding or applications involving high-power pulses.

The great care taken when manufacturing our sensors means they benefit from particularly homogeneous winding, with equidistant turns along the whole length of the sensor, thus ensuring good immunity against electromagnetic interference.

The MiniFLEX models are made up of a flexible sensor connected to a casing containing processing electronics which outputs a voltage with the same amplitude and form as the current measured.

### ■ MiniFLEX MA100 series:

With their small diameter and size, the sensors in the MA100 series are ideal for measuring currents in the electrical cabinets of residential or tertiary buildings or in low-power cabinets in industry.

Available with "banana" or "BNC" connection technology, the MA100 series can be connected directly to a multimeter, a wattmeter or a logger for RMS measurements at the standard industrial frequencies.

### ■ MiniFLEX MA200 series:

The MA200 series is a family of "high-frequency" sensors specially designed for viewing and measuring electrical or electrotechnical signals with wide variations and high amplitude.

These "insulated current probes for oscilloscopes" offer a bandwidth of 1 MHz and can be used to analyse currents with complex forms, transients present in electronic power supplies, welding units, etc.

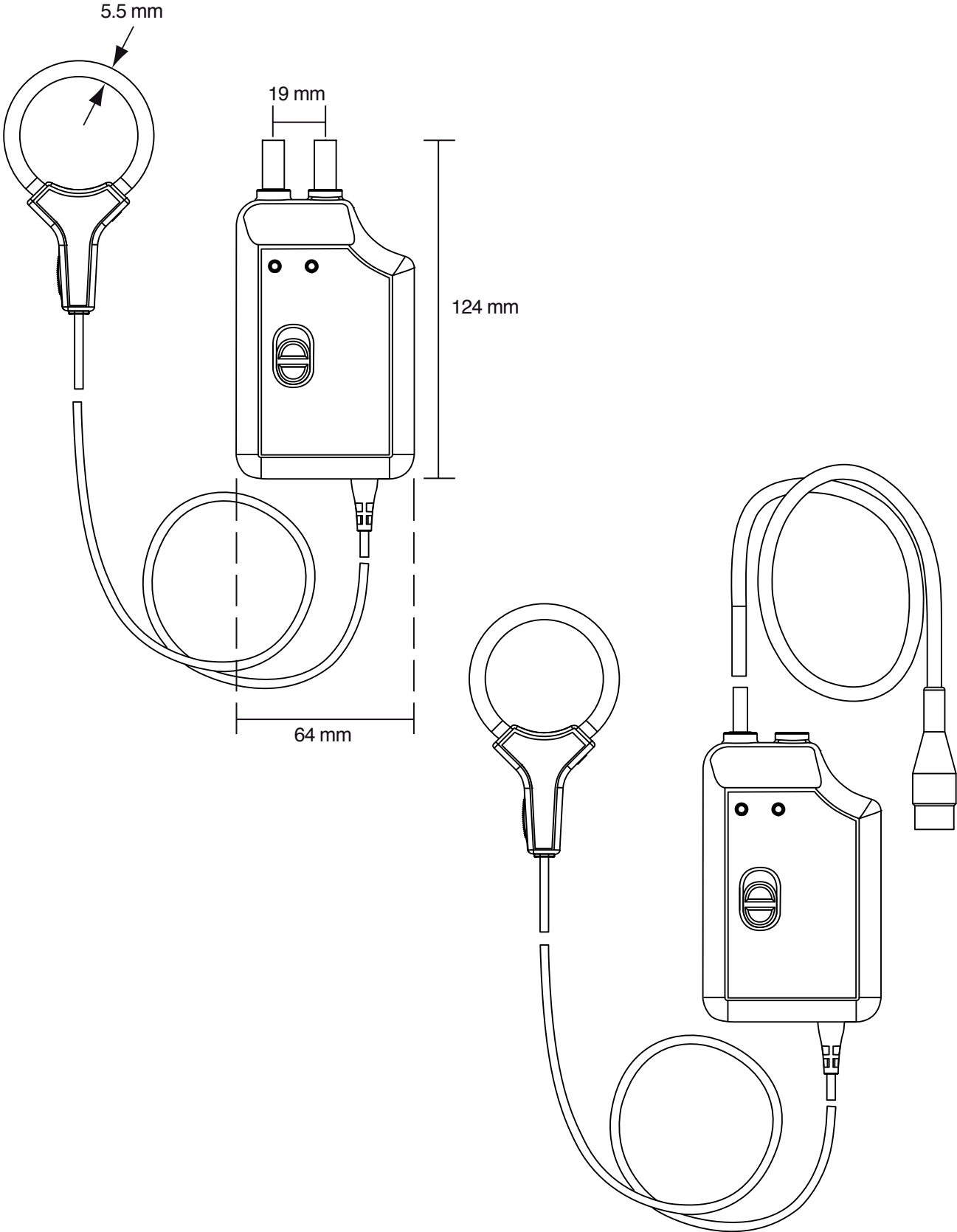

# Flexible probe for AC current

## Model MA100 30-300/3

MiniFLEX series

Current	30 AAC	300 AAC
Output	100 mV/A	10 mV/A

### Description

The model MA100 MiniFLEX sensor is a flexible sensor comprising an active part (Rogowski coil) linked to a casing containing electronics.

Unlike a current clamp with magnetic circuits, the MiniFLEX models are flexible and are not subject to magnetic saturation constraints, so they offer excellent linearity, low phase shift and a large dynamic range for measurement (up to several kA) while remaining easy to use.

The sensors' flexibility makes it simple to clamp and measure any conductor, whatever its type (cable, busbar, strand, etc. and accessibility).

The click-lock system for opening and closing the coil is specially designed for use with safety gloves.

Depending on the model, the MA100 can be connected to the AC voltage input of:

- any multimeter with Ø 4 mm female plugs with 19 mm spacing
- any measurement instrument equipped with BNC connection technology.



### Specifications for current measurement <sup>(1)</sup>

Calibre	30 A	300 A
Measurement range in use	0.5...30 A AC	0.5...300 A AC
Specified measurement range <sup>(2)</sup>	5...30 A AC	5...300 A AC
Output/input ratio	100 mV/A	10 mV/A
Bandwidth at -3 dB	2 Hz...20 kHz	
Accuracy in % of output signal	≤ 1 %	
Phase shift at 50 Hz	≤ 1.5°	
Residual current (noise) at I = 0	≤ 0.5 A rms	
Output impedance	1 kΩ	

# Flexible probe for AC current

## Model MA100 30-300/3

MiniFLEX series

### ■ Electrical specifications <sup>(1)</sup>

#### Operating voltage:

600 V rms (Cat. IV)  
1000 V rms (Cat. III)

#### Battery:

9 V alkaline battery (NEDA 1604A, IEC 6LR61)

#### Battery life:

100 hours typical

#### Typical consumption:

3.6 mA typical

#### Battery level indication:

Green LED when > 7.0 V approx.

#### Influence of battery voltage:

≤ 0.1 % from 9 V to 7 V

#### Influence of temperature:

≤ 0.2 % / 10 °K

#### Influence of humidity:

≤ 0.3 % from 10 % to 90 % RH without condensation

#### Influence of conductor position in the sensor <sup>(5)</sup>:

≤ 2.5 %

#### Influence of sensor deformation <sup>(3)</sup>:

≤ 1.5 %

#### Influence of an adjacent conductor with circulating AC current <sup>(4)</sup>:

≤ 1 % or 40 dB

#### Common mode rejection:

- between enclosure and secondary:

≤ 65 dB

- between sensor and secondary: ≤ 88 dB

#### Influence of the measurement instrument's impedance Z:

0.1 % / Z (in MΩ)

### ■ Mechanical specifications

#### Clamping capacity:

Model 170 mm: Ø max 45 mm

#### Operating temperature:

-10 °C to +55 °C

#### Storage temperature:

-40 °C to +70 °C

#### Max. temperature of clamped conductor (measured):

≤ 90 °C

#### Relative humidity for operation:

0 to 85 % RH with a linear decrease above 35 °C

#### Operating altitude:

0 to 2,000 m

#### Storage altitude:

≤ 12,000 m

#### Casing protection rating (leakproofing):

Casing: IP50

Sensor: IP50

according to EN 60529/A1 Ed.06/2000

#### Shock resistance:

IK04 according to EN 50102 Ed.1995

#### Self-extinguishing capability:

Casing: UL94-V2

Sensor: UL94 V0

#### Dimensions:

Casing: 140 x 64 x 28 mm

Connector lead: 2 m (connects sensor to casing)

Ø of sensor: 5.5 mm approx.

Connection cable Ø: 3 mm approx.

### Colours:

Sensor: red

Sensor closing system: dark grey

Sensor locking tab: yellow

Casing: dark grey

### Output:

Depending on model:

- 2 x Ø 4 mm safety plugs with 19 mm spacing or

- Coaxial cable 40 cm long, terminated by an insulated BNC plug

### ■ Safety specifications

#### Electrical safety:

Class II equipment with double or reinforced insulation between the primary and the secondary (winding connected to the connection cable) as per EN 61010-1 and 61010-2-032:

- 1000 V Cat. III, pollution degree 2

- 600 V Cat. IV, pollution degree 2

- Type-B sensor

- 600 V Cat. III between the terminals or between the BNC output (depending on model) and the external enclosure of the casing

#### Electromagnetic compatibility (EMC):

Complies with the IEC 61326 (Ed. 1997) + A1 (Ed. 1998)

- Adequate immunity to disturbances for industrial environments

- Adequate immunity to disturbances for residential environments

(1) Conditions of reference: 23 °C ± 5 °K, 20 % to 75 % RH

Battery voltage: 9 V ± 0.5 V

Continuous external DC magnetic field (earth field) < 40 A/m

Absence of external AC magnetic field

External electrical field < 1 V/m

Position of conductor measured: centred in the measurement coil

Shape of measurement coil: quasi-circular

Measurement instrument input impedance (oscilloscope) ≥ 1 MΩ

Frequency and form of signal measured: 40 to 400 Hz sinusoidal.

(2) Measurement range for the specifications indicated in this document

(3) Any position, Ø of conductor measured ≥ 5 mm

(4) Adjacent conductor 1 cm from sensor, ≤ 2 % or 34 dB near click-lock system

(5) ≤ 6 % near click-lock system

To order	Reference
MiniFLEX MA100 30-300 A / 3 V, length 170 mm, output via 2 x Ø 4 mm safety plugs with 19 mm spacing, with operating manual and battery	P01120560
MiniFLEX MA100 30-300 A / 3 V, length 170 mm, insulated BNC output with BNC Ø 4 mm banana adapter, with operating manual and battery	P01120563

# Flexible probe for AC current

## Model MA100 300-3000/3

MiniFLEX series

Current	300 A AC	3000 A AC
Output	10 mV/A	1 mV/A

### Description

The MiniFLEX MA100 sensor is a flexible sensor comprising an active part (Rogowski coil) linked to a casing containing electronics.

Unlike a current clamp with magnetic circuits, the MiniFLEX models are flexible and are not subject to magnetic saturation constraints, so they offer excellent linearity, low phase shift and a large dynamic range for measurement (up to several kA) while remaining easy to use.

The sensors' flexibility makes it simple to clamp and measure any conductor, whatever its type (cable, busbar, strand, etc. and accessibility).

The click-lock system for opening and closing the coil is specially designed for use with safety gloves.

Depending on the model, the MA100 can be connected to the AC voltage input of:

- any multimeter with  $\varnothing$  4 mm female plugs with 19 mm spacing
- any measurement instrument equipped with BNC connection technology.



### Specifications for current measurement <sup>(1)</sup>

Calibre	300 A	3000 A
Measurement range in use	0.5...300 A AC	0.5...3000 A AC
Specified measurement range <sup>(2)</sup>	5...300 A AC	5...3000 A AC
Output/input ratio	10 mV/A	1 mV/A
Bandwidth at -3 dB <sup>(6)</sup>	2 Hz...20 kHz	
Accuracy in % of output signal	$\leq 1\%$	
Phase shift at 50 Hz	$\leq 1.5^\circ$	
Residual current (noise) at I = 0	$\leq 0.5$ A rms	
Output impedance	1 k $\Omega$	



# Flexible probe for AC current

## Model MA100 300-3000/3

MiniFLEX series

### Electrical specifications <sup>(1)</sup>

**Operating voltage:**  
600 V rms (Cat. IV)  
1000 V rms (Cat. III)

**Battery:**  
9 V alkaline battery (NEDA 1604A, IEC 6LR61)

**Battery life:**  
100 hours typical

**Typical consumption:**  
3.6 mA typical

**Battery level indication:**  
Green LED when > 7.0 V approx.

**Influence of battery voltage:**  
≤ 0.1 % from 9 V to 7 V

**Influence of temperature:**  
≤ 0.2 % / 10 K

**Influence of humidity:**  
≤ 0.3 % from 10 % to 90 % RH without condensation

**Influence of conductor position in the sensor <sup>(5)</sup>:**  
≤ 2.5 %

**Influence of sensor deformation <sup>(3)</sup>:**  
≤ 1.5 %

**Influence of an adjacent conductor with circulating AC current <sup>(4)</sup>:**  
≤ 1 % or 40 dB

**Common mode rejection:**  
- between enclosure and secondary: ≤ 65 dB  
- between sensor and secondary: ≤ 88 dB

**Influence of the measurement instrument's impedance Z:**  
0.1 % / Z (in MΩ)

### Mechanical specifications

**Clamping capacity:**  
Model 250 mm: Ø max 70 mm  
Model 350 mm: Ø max 100 mm

**Operating temperature:**  
-10 °C to +55 °C

**Storage temperature:**  
-40 °C to +70 °C

**Max. temperature of clamped conductor (measured):**  
≤ 90 °C

**Relative humidity for operation:**  
0 to 85 % RH with a linear decrease above 35 °C

**Operating altitude:**  
0 to 2,000 m

**Storage altitude:**  
≤ 12,000 m

**Casing protection rating (leakproofing):**  
Casing: IP50  
Sensor: IP50  
according to EN 60529/A1 Ed.06/2000

**Shock resistance:**  
IK04 according to EN 50102 Ed. 1995

**Self-extinguishing capability:**  
Casing: UL94-V2  
Sensor: UL94 V0

**Dimensions:**  
Casing: 140 x 64 x 28 mm  
Connector lead: 2 m (connects sensor to casing)  
Ø of sensor: 5.5 mm approx.  
Connection cable Ø: 3 mm approx.

### Colours:

Sensor: red  
Sensor closing system: dark grey  
Sensor locking tab: yellow  
Casing: dark grey

### Output:

Depending on model:  
- 2 x Ø 4 mm safety plugs with 19 mm spacing or  
- Coaxial cable 40 cm long, terminated by an insulated BNC plug

### Safety specifications

#### Electrical safety:

Class II equipment with double or reinforced insulation between the primary and the secondary (winding connected to the connection cable) as per EN 61010-1 and 61010-2-032:  
- 1000 V Cat. III, pollution degree 2  
- 600 V Cat. IV, pollution degree 2  
- Type-B sensor  
- 600 V Cat. III between the terminals or between the BNC output (depending on model) and the external enclosure of the casing

#### Electromagnetic compatibility (EMC):

Complies with the IEC 61326 (Ed. 1997) + A1 (Ed. 1998)  
- Adequate immunity to disturbances for industrial environments  
- Adequate immunity to disturbances for residential environments

(1) Conditions of reference: 23 °C ± 5 °K, 20 % to 75 % RH  
Battery voltage: 9 V ± 0.5 V  
Continuous external DC magnetic field (earth field) < 40 A/m  
Absence of external AC magnetic field  
External electrical field < 1 V/m  
Position of conductor measured: centred in the measurement coil  
Shape of measurement coil: quasi-circular  
Measurement instrument input impedance (oscilloscope) ≥ 1 MΩ  
Frequency and form of signal measured: 40 to 400 Hz sinusoidal.

(2) Measurement range for the specifications indicated in this document

(3) Any position, Ø of conductor measured ≥ 5 mm

(4) Adjacent conductor 1 cm from sensor, ≤ 2 % or 34 dB near click-lock system

(5) ≤ 6 % near click-lock system

(6) Frequency limitation according to amplitude

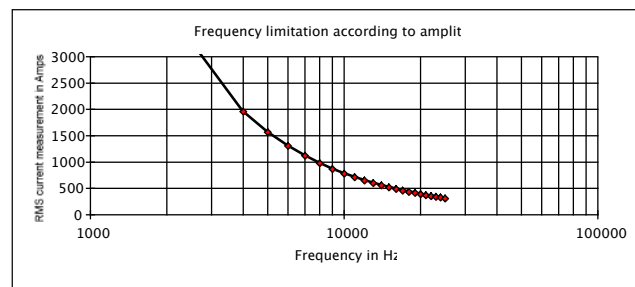

To order	Reference
MiniFLEX MA100 300-3000 A / 3 V, length 250 mm, output via 2 x Ø 4 mm safety plugs with 19 mm spacing, with operating manual and battery	P01120561
MiniFLEX MA100 300-3000 A / 3 V, length 350 mm, output via 2 x Ø 4 mm safety plugs with 19 mm spacing, with operating manual and battery	P01120562
MiniFLEX MA100 300-3000 A / 3 V, length 250 mm, insulated BNC output with BNC Ø 4 mm banana adapter, with operating manual and battery	P01120564
MiniFLEX MA100 300-3000 A / 3 V, length 350 mm, insulated BNC output with BNC Ø 4 mm banana adapter, with operating manual and battery	P01120565

# Flexible probe for AC current

## Model MA200 30-300/3 (insulated AC current probe)

MiniFLEX series

Current	45 A peak	450 A peak
Output	100 mV/A	10 mV/A

### Description

The MiniFLEX MA200 is a flexible sensor comprising an active part (Rogowski coil) linked to a casing containing electronics. Unlike a current clamp with magnetic circuits, the MiniFLEX models are flexible and are not subject to magnetic saturation constraints, so they offer excellent linearity, low phase shift and a large dynamic range for measurement (up to several kA) while remaining easy to use.

The oscilloscope probes in the MA200 series are specially designed for viewing alternating currents in order to assess the transition and propagation times on electrotechnical equipment.

The sensors' flexibility makes it simple to clamp and measure any conductor, whatever its type (cable, busbar, strand, etc.) and accessibility.

The click-lock system for opening and closing the coil is specially designed for use with safety gloves.

The casing can be connected to any oscilloscope equipped with an AC voltage input.



### Specifications for current measurement <sup>(1)</sup>

Calibre	30 A	300 A
Measurement range in use	0.5...30 A AC (45 A peak)	0.5...300 A AC (450 A peak)
Specified measurement range <sup>(2)</sup>	5...30 A AC (45 A peak)	5...300 A AC (450 A peak)
Output/input ratio	100 mV/A	10 mV/A
Accuracy in % of output signal	≤ 1 % + 0.3 A	
Phase shift at 1 kHz	≤ 1.5°	
Residual current (noise) at I = 0	≤ 0.5 A rms	
Output impedance	1 kΩ	

### Frequency measurement specifications <sup>(1)</sup>

Calibre	30 A	300 A
Bandwidth at -3 dB	2 Hz...1 MHz	2 Hz...1 MHz
Rise time <sup>(3)</sup> (10 to 90 %)	0.3 μs (typical)	0.24 μs (typical)
Fall time <sup>(4)</sup> (10 to 90 %)	0.3 μs (typical)	0.24 μs (typical)
Propagation time <sup>(5)</sup> (to 10 %)	0.4 μs (typical)	0.3 μs (typical)
Insertion impedance at 10 kHz	< 0.05 mΩ	



# Flexible probe for AC current

## Model MA200 30-300/3 (insulated AC current probe)

MiniFLEX series

### ■ Electrical specifications <sup>(1)</sup>

**Operating voltage:**

600 V rms (Cat. IV)  
1000 V rms (Cat. III)

**Battery:**

9 V alkaline battery (NEDA 1604A, IEC 6LR61)

**Battery life:**

100 hours typical

**Typical consumption:**

3.6 mA typical

**Battery level indication:**

Green LED when > 7.0 V approx.

**Influence of battery voltage:**

≤ 0.1 % from 9 V to 7 V

**Influence of temperature:**

≤ 0.2 % / 10 K

**Influence of humidity:**

≤ 0.5 % from 10 % to 90 % RH without condensation

**Influence of conductor position in the sensor <sup>(8)</sup>:**

≤ 2.5 %

**Influence of sensor deformation <sup>(6)</sup>:**

≤ 1 %

**Influence of an adjacent conductor with circulating AC current (7):**

≤ 1.5 % or 36.5 dB

**Common mode rejection:**

- between enclosure and secondary:  
≤ 75 dB  
- between sensor and secondary: ≤ 80 dB

**Influence of the measurement instrument's impedance Z:**

0.1 % / Z (in MΩ)

### ■ Mechanical specifications

**Clamping capacity:**

Model 170mm: Ø max 45 mm  
Model 250mm: Ø max 70 mm

**Operating temperature:**

-10 °C to +55 °C

**Storage temperature:**

-40 °C to +70 °C

**Max. temperature of clamped conductor (measured):**

≤ 90 °C

**Relative humidity for operation:**

0 to 85 % RH with a linear decrease above 35 °C

**Operating altitude:**

0 to 2,000 m

**Storage altitude:**

≤ 12,000 m

**Casing protection rating (leakproofing):**

Casing: IP50  
Sensor: IP50  
according to EN 60529/A1 Ed.06/2000

**Shock resistance:**

IK04 according to EN 50102 Ed. 1995

**Self-extinguishing capability:**

Casing: UL94-V2  
Sensor: UL94 V0

**Dimensions:**

Casing: 140 x 64 x 28 mm  
Connector lead: 2 m (connects sensor to casing)  
Ø of sensor: 5.5 mm approx.  
Connection cable Ø: 3 mm approx.

**Colours:**

Sensor: red  
Sensor closing system: dark grey  
Sensor locking tab: yellow  
Casing: dark grey

**Output:**

Depending on model:  
Coaxial cable 40 cm long, terminated by an insulated BNC plug

### ■ Safety specifications

**Electrical safety:**

Class II equipment with double or reinforced insulation between the primary and the secondary (winding connected to the connection cable) as per EN 61010-1 and 61010-2-032:  
- 1000 V Cat. III, pollution degree 2  
- 600 V Cat. IV, pollution degree 2  
- Type-B sensor  
- 600 V Cat. III between the BNC output and the external enclosure of the casing

**Electromagnetic compatibility (EMC):**

Complies with the IEC 61326 (Ed. 1997) + A1 (Ed. 1998)  
- Adequate immunity to disturbances for industrial environments  
- Adequate immunity to disturbances for residential environments

(1) Conditions of reference: 23 °C ± 5 °K, 20 % to 75 % RH

Battery voltage: 9 V ± 0.5 V

Continuous external DC magnetic field (earth field) < 40 A/m

Absence of external AC magnetic field

External electrical field < 1 V/m

Position of conductor measured: centred in the measurement coil

Shape of measurement coil: quasi-circular

Measurement instrument input impedance (oscilloscope) ≥ 1 MΩ

Frequency and form of signal measured: 40 to 400 Hz sinusoidal.

(2) Measurement range for the specifications indicated in this document

(3) Rise time (t<sub>r</sub>)

(4) Fall time (t<sub>f</sub>)

(5) Delay time (t<sub>d</sub>)

(6) Oblong shape

(7) Adjacent conductor 1 cm from sensor ; ≤ 3 % or 30.5 dB near click-lock system

(8) ≤ 6 % near click-lock system

(9) Typical curve obtained by mathematical modelling

To order	Reference
MiniFLEX MA200 30-300 A / 3 V, length 170 mm with operating manual and battery	P01120570
MiniFLEX MA200 30-300 A / 3 V, length 250 mm with operating manual and battery	P01120571

# Flexible probe for AC current

## Model MA200 30-300/3 (insulated AC current probe)

MiniFLEX series

### 170 mm loop - 30 A calibre

Frequency and phase responses <sup>(9)</sup>

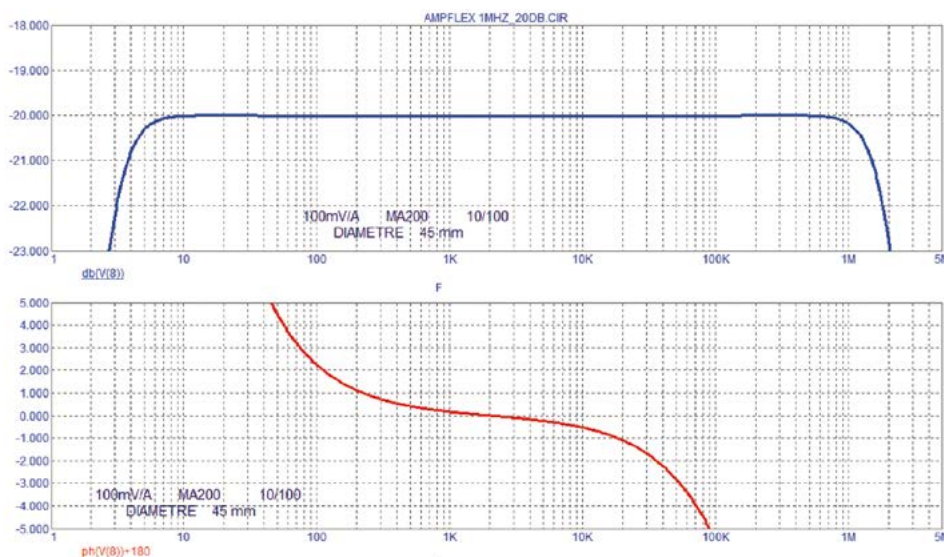

Pulse response

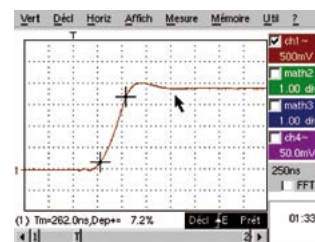

### 170 mm loop - 300 A calibre

Frequency and phase responses <sup>(9)</sup>

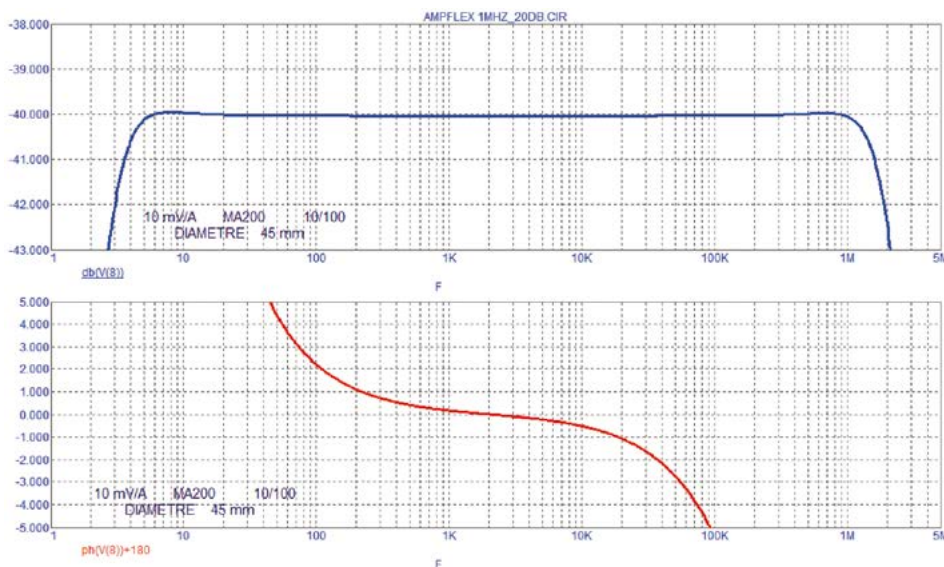

Pulse response

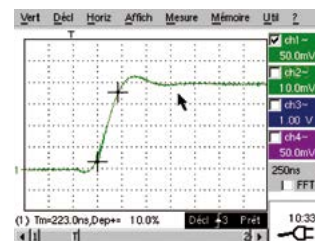

# Flexible probe for AC current

## Model MA200 30-300/3 (insulated AC current probe)

MiniFLEX series

### 250 mm loop - 30 A calibre

Frequency and phase responses <sup>(9)</sup>

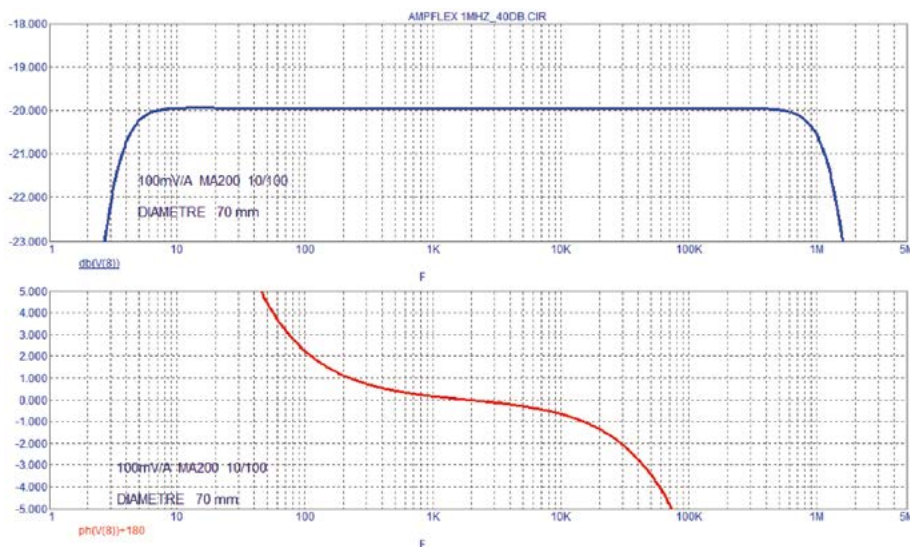

Pulse response

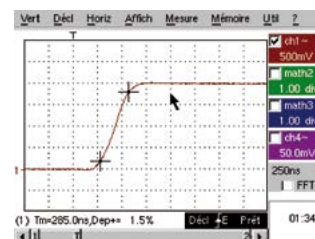

### 250 mm loop - 300 A calibre

Frequency and phase responses <sup>(9)</sup>

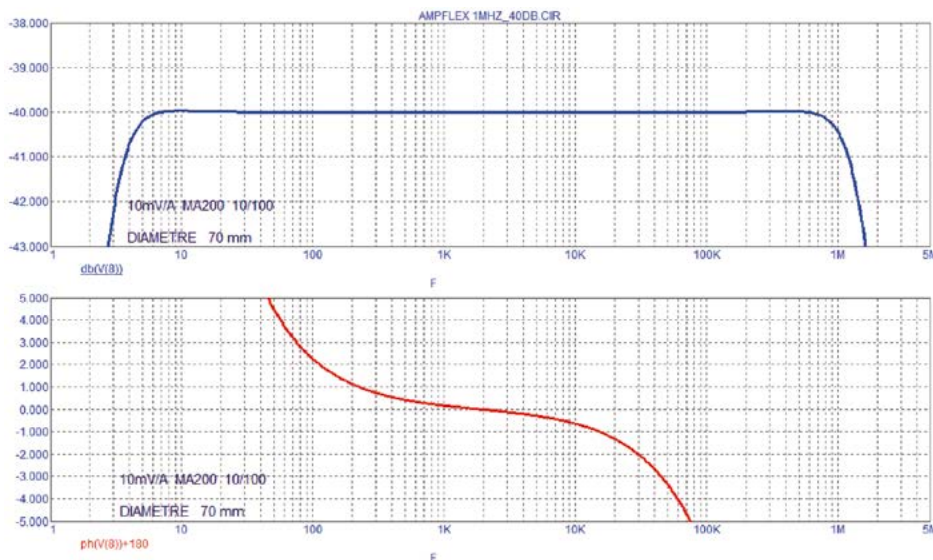

Pulse response

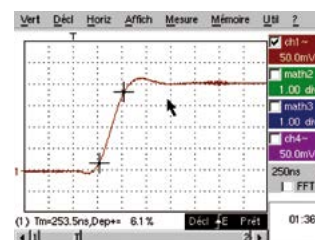

# Flexible probe for AC current

## Model MA200 3000/3 (insulated AC current probe)

MiniFLEX series

Current	4500 A peak
Output	1 mV/A

### Description

The MiniFLEX MA200 is a flexible sensor comprising an active part (Rogowski coil) linked to a casing containing electronics.

Unlike a current clamp with magnetic circuits, the MiniFLEX models are flexible and are not subject to magnetic saturation constraints, so they offer excellent linearity, low phase shift and a large dynamic range for measurement (up to several kA) while remaining easy to use.

The oscilloscope probes in the MA200 series are specially designed for viewing alternating currents in order to assess the transition and propagation times on electrotechnical equipment.

The sensors' flexibility makes it simple to clamp and measure any conductor, whatever its type (cable, busbar, strand, etc.) and accessibility.

The click-lock system for opening and closing the coil is specially designed for use with safety gloves.

The casing can be connected to any oscilloscope equipped with an AC voltage input.



### Specifications for current measurement <sup>(1)</sup>

Calibre	3000 A
Measurement range in use	0.5...3000 AAC (4500 A peak)
Specified measurement range <sup>(2)</sup>	5...3000 AAC (4500 A peak)
Output/input ratio	1 mV/A
Accuracy in % of output signal	≤ 1 % + 0.3 A
Phase shift at 1 kHz	≤ 1.5°
Residual current (noise) at I = 0	≤ 0.5 A rms
Output impedance	1 kΩ

### Frequency measurement specifications <sup>(1)</sup>

Calibre	3000 A
Bandwidth at -3 dB <sup>(6)</sup>	2 Hz...1 MHz
Rise time <sup>(3)</sup> (10 to 90 %)	0.3 μs (typical)
Fall time <sup>(4)</sup> (10 to 90 %)	0.3 μs (typical)
Propagation time <sup>(5)</sup> (to 10 %)	0.4 μs (typical)
Insertion impedance at 10 kHz	< 0.05 mΩ

# Flexible probe for AC current

## Model MA200 3000/3 (insulated AC current probe)

MiniFLEX series

### Electrical specifications <sup>(1)</sup>

#### Operating voltage:

600 V rms (Cat. IV)  
1000 V rms (Cat. III)

#### Battery:

9 V alkaline battery (NEDA 1604A, IEC 6LR61)

#### Battery life:

100 hours typical

#### Typical consumption:

3.6 mA typical

#### Battery level indication:

Green LED when > 7.0 V approx.

#### Influence of battery voltage:

≤ 0.1 % from 9 V to 7 V

#### Influence of temperature:

≤ 0.6 % / 10 K

#### Influence of humidity:

≤ 0.5 % from 10 % to 90 % RH without condensation

#### Influence of conductor position in the sensor <sup>(9)</sup>:

≤ 2.5 %

#### Influence of sensor deformation <sup>(7)</sup>:

≤ 1 %

#### Influence of an adjacent conductor with circulating AC current <sup>(8)</sup>:

≤ 1.5 % or 36.5 dB  
- between enclosure and secondary: ≤ 75 dB  
- between sensor and secondary: ≤ 80 dB

#### Influence of the measurement instrument's impedance Z:

0.1 % / Z (in MΩ)

### Mechanical specifications

#### Clamping capacity:

Model 350 mm: Ø max 100 mm

#### Operating temperature:

-10 °C to +55 °C

#### Storage temperature:

-40 °C to +70 °C

#### Max. temperature of clamped conductor (measured):

≤ 90 °C

#### Relative humidity for operation:

0 to 85 % RH with a linear decrease above 35 °C

#### Operating altitude:

0 to 2,000 m

#### Storage altitude:

≤ 12,000 m

#### Casing protection rating (leakproofing):

Casing: IP50

Sensor: IP50

according to EN 60529/A1 Ed. 06/2000

#### Shock resistance:

IK04 according to EN 50102 Ed. 1995

#### Self-extinguishing capability:

Casing: UL94 V2

Sensor: UL94 V0

#### Dimensions:

Casing: 140 x 64 x 28 mm

Connector lead: 2 m (connects sensor to casing)

Ø of sensor: 5.5 mm approx.

Connection cable Ø: 3 mm approx.

### Colours:

Sensor: red

Sensor closing system: dark grey

Sensor locking tab: yellow

Casing: dark grey

### Output:

Coaxial cable 40 cm long, terminated by an insulated BNC plug

### Safety specifications

#### Electrical safety:

Class II equipment with double or reinforced insulation between the primary and the secondary (winding connected to the connection cable) as per EN 61010-1 and 61010-2-032:

- 1000 V Cat. III, pollution degree 2

- 600 V Cat. IV, pollution degree 2

- Type-B sensor

- 600 V Cat. III between the BNC output and the external enclosure of the casing

#### Electromagnetic compatibility (EMC):

Complies with the IEC 61326 (Ed. 1997) + A1 (Ed. 1998)

- Adequate immunity to disturbances for industrial environments

- Adequate immunity to disturbances for residential environments

(1) Conditions of reference: 23 °C ± 5 °K, 20 % to 75 % RH  
Battery voltage: 9 V ± 0.5 V  
Continuous external DC magnetic field (earth field) < 40 A/m  
Absence of external AC magnetic field  
External electrical field < 1 V/m  
Position of conductor measured: centred in the measurement coil  
Shape of measurement coil: quasi-circular  
Measurement instrument input impedance (oscilloscope) ≥ 1 MΩ  
Frequency and form of signal measured: 40 to 400 Hz sinusoidal.

(2) Measurement range for the specifications indicated in this document

(3) Rise time (tr)

(4) Fall time (tf)

(5) Delay time (td)

(6) Frequency limitation according to amplitude

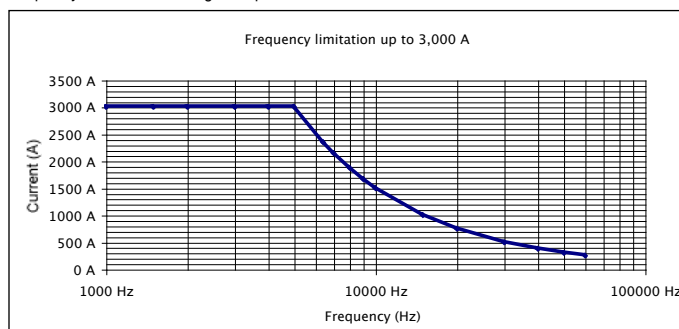

(7) Oblong shape

(8) Adjacent conductor 1 cm from sensor ; ≤ 3 % or 30.5 dB near click-lock system

(9) ≤ 6 % near click-lock system

(10) Typical curve obtained by mathematical modelling

To order	Reference
MiniFLEX MA200 3000 A / 3 V, length 350 mm with operating manual and battery	P01120572

# Flexible probe for AC current

## Model MA200 3000/3 (insulated AC current probe)

MiniFLEX series

### 3000 A calibre

Frequency and phase responses <sup>(10)</sup>

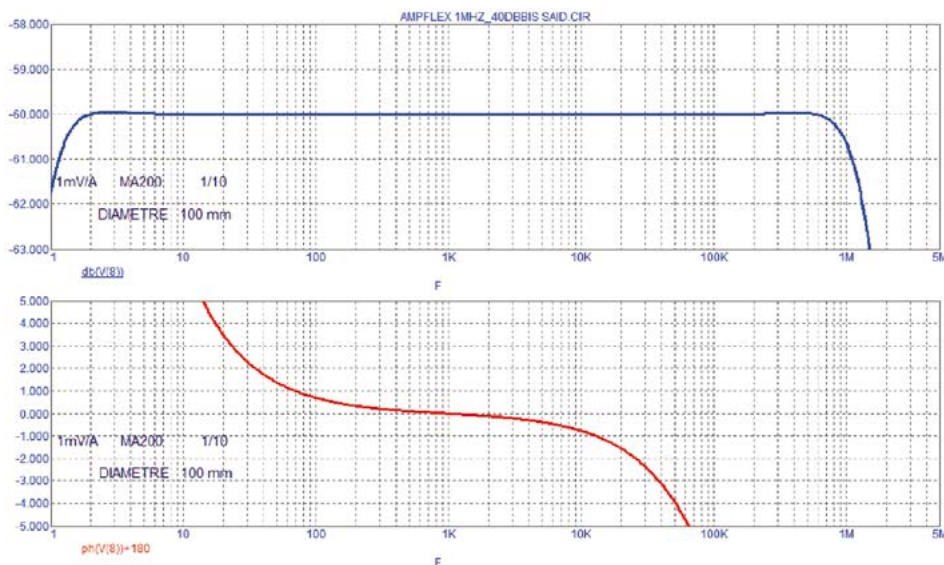

Pulse response

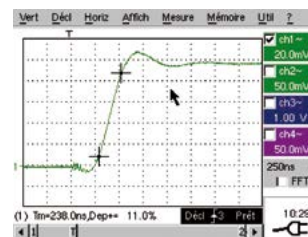



# Flexible probe for AC current

## Model MA101

MiniFLEX series

### ⚠ CAUTION

**These products are only offered under certain conditions (quantity, etc.) to manufacturers of measurement, location and detection instruments.**

MiniFLEX sensors offer excellent linearity, low phase shift and a large measurement range (up to several kA), as well as unrivalled simplicity of use. The MA101 series is Chauvin Arnoux's response to all the measurement instrument manufacturers seeking to integrate the MiniFLEX solution as native in their measurement products, particularly for industrial or tertiary applications involving difficult access or confined spaces.



Models produced on request	
Sensor length	From 140 mm
Connection cable length	From 50 cm
Connection	Tinned bare wires, BNC, FRB,...
Pairing	Multi-sensor use,....

### ■ Description

The MA 101 MiniFLEX sensor is a flexible sensor comprising an active part (Rogowski coil) and a connection cable. It requires additional electronics (not delivered with the sensor).

For applications where several sensors need to be used (three-phase measurements, etc.), Chauvin Arnoux carries out an additional operation during manufacturing to ensure that they are fully interchangeable.

### ■ Electrical specifications <sup>(1)</sup>

**Voltage developed at sensor terminals:**  
46.5  $\mu$ V / A (-15 % / +10 %) at 50 Hz

**Linearity <sup>(1)</sup>:**  
 $\leq 0.3$  %

**Phase shift <sup>(1)</sup>:**  
 $-90^\circ \pm 0,5^\circ$  at 50 Hz

**Bandwidth:**  
Depends on associated electronics

**Interchangeability error:**  
 $\leq 0.5$  % (maximum error between 2 paired sensors on the same measurement point)

**Operating voltage:**  
600 V rms or DC (Cat. IV)  
1000 V rms or DC (Cat. III)

**Influence of temperature:**  
0.05 %/10 °K from -20 °C to +60 °C

**Influence of humidity:**  
0.1 % from 10 % to 90 % RH

**Influence of conductor position with no sensor deformation:**  
 $\leq 1.5$  %

**Influence of adjacent conductor placed 1 cm from sensor:**  
 $\leq 0.7$  % of the adjacent current at 50 Hz

**Influence of sensor deformation (flattened/oblong shape):**  $\leq 0.5$  %

**Common mode rejection <sup>(2)</sup>:**  
 $\geq 100$  dB for a voltage of 600 V/50 Hz applied between the sensor enclosure and the secondary

### ■ Mechanical specifications

**Clamping capacity:**  
Depends on sensor length

**Operating temperature:**  
-20 °C to +60 °C

**Storage temperature:**  
-40 °C to +80 °C

**Max. temperature of clamped conductor (measured):**  
 $\leq 90$  °C

**Operating altitude:**  
0 to 2,000 m

**Storage altitude:**  
 $\leq 12,000$  m

**Casing protection rating (leakproofing):**  
IP50 according to EN 60529/A1 Ed.06/2000

**Self-extinguishing capability:**  
UL94 V0

### Dimensions:

$\varnothing$  of sensor: 5.5 mm approx.  
Connection cable  $\varnothing$ : 3 mm approx.

**Weight:**  
30 g approx. per 10 cm length of sensor

**Colours:**  
Sensor: red  
Sensor closing system: dark grey  
Sensor locking tab: yellow

**Connection cable:**  
Length as requested, with 10 cm increments

**Connection:**  
As requested: specify reference, model and pin configuration required

### ■ Safety specifications

#### Electrical safety:

Class II equipment with double or reinforced insulation between the primary and the secondary (winding connected to the connection cable) as per EN 61010-1 and 61010-2-032:

- 1000 V Cat. III, pollution degree 2
- 600 V Cat. IV, pollution degree 2
- Type-B sensor

#### Electromagnetic compatibility (EMC):

Not applicable as delivered.  
Applicable only for the sensor with its associated electronics which must include EMC protection systems.  
The sensor does not contain any EMC protection systems (as it is by nature an electromagnetic field sensor).

(1) Conditions of reference: 23 °C  $\pm$  5 °K, 20 to 75 % RH, continuous external magnetic field < 40 A/m, absence of magnetic and electrical fields, frequency of signal measured 10 Hz to 100 Hz sinusoidal  
(2) Ratio expressed in dB to be converted into the equivalent in Amperes while taking into account the sensor's sensitivity and the gain of the associated electronics.

To receive a quotation, please answer the following questions:	
What sensor length do you require? (140 mm minimum, with 10 mm increments)	..... mm
What connection cable length do you require? (50 cm minimum, with 10 cm increments)	..... cm
What connection system do you require? (the output from the sensor comprises 2 active conductors (hot point, cold point) and shielding)	None (tinned bare wires) or Specify connector reference, model and manufacturer and the wiring required
Does your application use several MA 101 sensors? If YES, is sensor interchangeability required?	YES / NO YES / NO
If YES, what is the input impedance of the equipment to which the MA 101 will be connected?	..... $\Omega$



## AmpFLEX™ series

These flexible current probes are as at home measuring low AC currents of a few hundred mA as they are measuring high currents of several tens of kA.

Their main point of interest is their flexibility and the ease with which electrical conductors of all shapes and sizes (cables, busbars) and degrees of accessibility can be gripped.

They have a number of other advantages; they are lightweight (no magnetic circuit), they do not suffer from the saturation effect and their high level of accuracy combined with minimal phase shift make them perfect for power measurement applications.

### ■ AmpFLEX™ A100 series:

The A100 (pictured above) has a flexible toroid which connects, via a screened lead, to a small unit containing all the processing electronics and a standard 9 V battery.

The unit can be connected directly to any multimeter, wattmeter or recording device. With either one or two calibres, the A100 models give an AC voltage output of 0.1 - 1 - 10 or 100 mV/A. As well as the standard models (45, 80, or 120 cm's), there are also models available on request for which you can choose the sensor length and sensitivity.

### ■ AmpFLEX™ A101 series:

The A101 has exactly the same specification as the A100 models but comes without the electronic unit. These sensors are used by other manufacturers and integrated into their own test and measurement products.

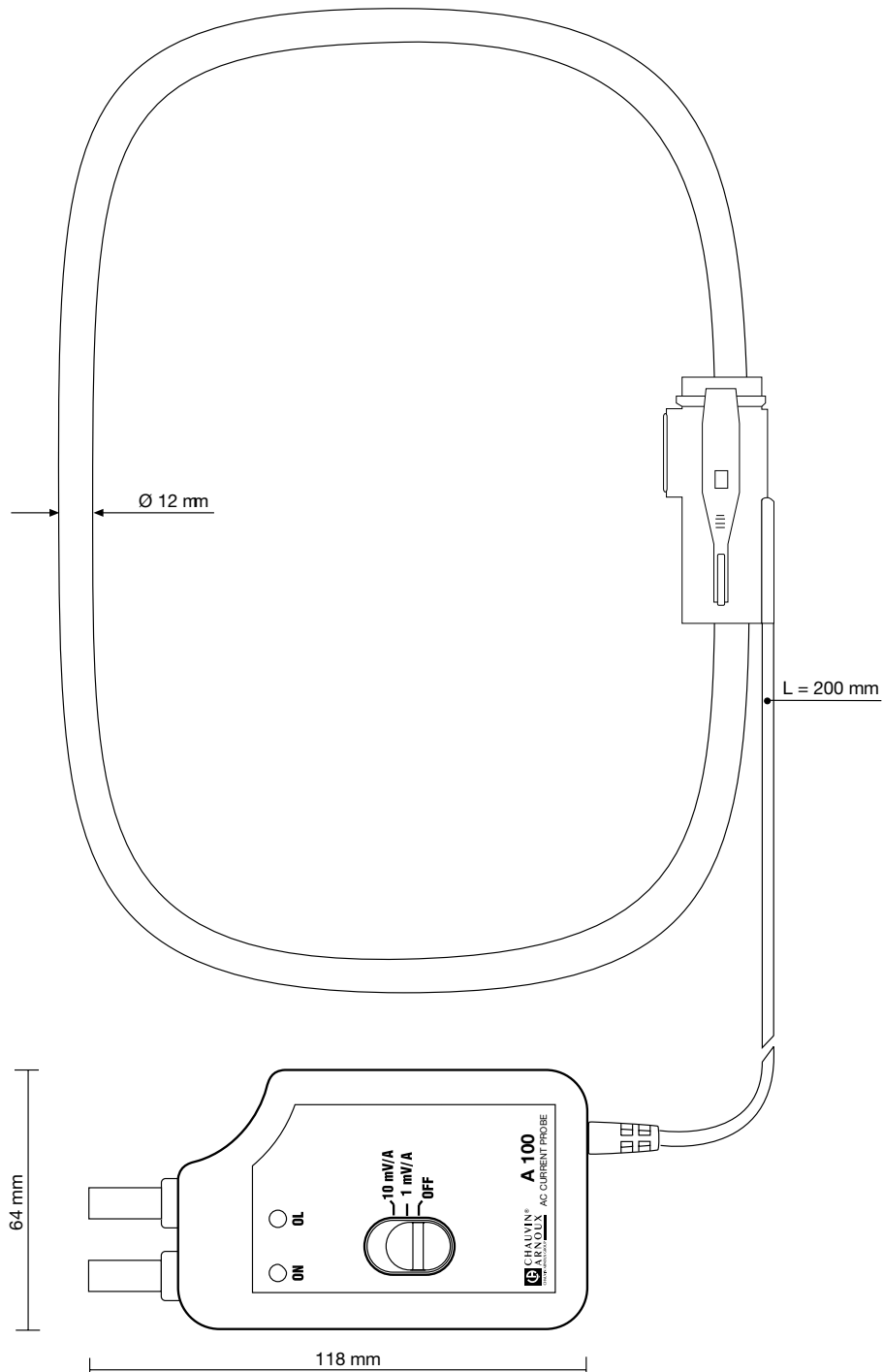

# Flexible probe for AC current

## Model A100 20-200 / 2

AmpFLEX™ series

Current	20 A AC	200 A AC
Output	100 mV/A	10 mV/A

### Electrical specifications

#### Current calibres:

0.5 A AC ... 20 A AC  
0.5 A AC ... 200 A AC

#### Output signal:

100 mVAC/A AC (2 V for 20 A)  
10 mVAC/A AC (2 V for 200 A)

#### Accuracy <sup>(1)</sup>:

Calibre	20 A		200 A	
	Primary current	0.5 A...5 A	5...20 A	0.5 A...5 A
% Accuracy of output signal	not specified	≤ 1 %	not specified	≤ 1 %
Phase shift	≤ 1.3°	≤ 1.3°	≤ 1.3°	≤ 1.3°

#### Bandwidth:

10 Hz ... 20 kHz

#### Crest factor:

2.25 at rated current

#### Max. current / Max. output voltage:

No current limit, but maximum output is 4.5 V peak

#### Load impedance:

≥ 1 MΩ

#### Influence of Z load impedance:

≤ 0.1 % / Z, (Z in MΩ)

#### Output impedance:

1 kΩ

#### DC voltage shift at output:

■ 20 A calibre: ≤ 50 mV DC  
■ 200 A calibre: ≤ 5 mV DC

#### Operating voltage:

1000 V rms

#### Influence of adjacent conductor:

≤ 1 % interference current at 50 Hz  
(≤ 2 % near click-lock system)

#### Influence of conductor position in loop:

≤ 1 % (≤ 4 % near click-lock system)

#### Influence of sensor shape:

≤ 1 % for an oblong shape

#### Battery:

9 V alkaline battery (NEDA 1604A, IEC 6LR61)

#### Battery life:

≥ 150 hrs continuous,  
≥ 1000 x 1 minute measurements

#### Low battery signal:

Green LED: battery OK  
Flashing green LED: low battery  
No green LED: battery discharged

#### Overload signal:

red LED

### Mechanical specifications

#### Operating temperature:

-10 °C to +55 °C, (maximum temperature for sensor is 90 °C)

#### Storage temperature:

-40 °C to +70 °C

#### Influence of temperature:

≤ 0.5 % of output signal per 10 °K

#### Relative humidity for operation:

0 to 95 % RH with a linear decrease above 35 °C

#### Influence of relative humidity:

< 0.2 % of output signal from 10 % to 85 % RH

#### Operating altitude:

0 to 2,000 m

#### Casing protection rating:

Casing: IP40 (IEC 529)  
Flexible sensor: IP65 (IEC 529)

#### Drop test:

1 m (IEC 68-2-32)

#### Shock resistance:

100 g (IEC 68-2-27)

#### Vibration resistance (IEC 68-2-6):

5/15/5 1.5 mm  
15/25/15 1 mm  
25/55/25 0.25 mm

#### Self-extinguishing capability:

Casing, flexible sensor and click-lock system: UL94 V0

#### Dimensions:

Casing: 140 x 64 x 28 mm (overall)  
Connector lead: 2 m (connects sensor to casing)  
Flexible sensor: Ø 12 mm ± 0.5 mm

#### Weight:

Casing: < 200 g

Flexible sensor: approx. 30 g per 10 cm length

#### Bending radius:

≥ 15 mm

#### Colours:

Casing and connection leads: dark grey, red flexible sensor with dark grey click-lock system

#### Output:

2 safety sockets (4 mm) spacing 19 mm

### Safety specifications

#### Electrical safety:

Double insulation or reinforced insulation between primary, secondary and outer parts of casing liable to be handled, IEC 1010-1 - 1000 V category III, pollution degree 2

#### Electromagnetic compatibility (EMC):

EN 50081-1: compliant  
EN 50082-2:

- Electrostatic discharge: IEC 1000-4-2
- Radiated field: IEC 1000-4-3
- Fast transients: IEC 1000-4-4
- Electrical shocks: IEC 1000-4-5
- Magnetic field at 50/60Hz: IEC 1000-4-8

(1) Conditions of reference: 23°C ± 5°K, 20 % to 75 % RH, battery voltage: 9 V ± 0.5 V, external DC magnetic field < 40 A/m, no external magnetic or electrical field, conductor centred for measurement, sinusoidal signal: 10...100Hz.

To order	Reference
AmpFLEX™ 20-200/2, length 45 cm with operating manual	P01120503

# Flexible probe for AC current

## Model A100 2000/2

AmpFLEX™ series

Current	2000 A AC
Output	1 mV/A

### ■ Electrical specifications

#### Current calibre:

0.5 A AC ... 2000 A AC

#### Output signal:

1 mVAC/A AC (2 V for 2000 A)

#### Accuracy <sup>(1)</sup>:

Primary current	0.5 A...5 A	5 A...2000 A
% Accuracy of output signal	not specified	≤ 1 %
Phase shift	≤ 0.7°	≤ 0.7°

#### Bandwidth:

10 Hz ... 20 kHz

#### Crest factor:

2.25 at rated current

#### Max. current / Max. output voltage:

No current limit, but maximum output is 4.5 V peak

#### Load impedance:

≥ 1 MΩ

#### Influence of Z load impedance:

≤ 0.1 %/Z, (Z in MΩ)

#### Output impedance:

1 kΩ

#### DC voltage shift at output:

≤ 2 mV DC

#### Operating voltage:

1000 V rms

#### Influence of adjacent conductor:

≤ 1 % interference current at 50 Hz  
(≤ 2 % near click-lock system)

#### Influence of conductor position in loop:

≤ 1 % (≤ 4 % near click-lock system)

#### Influence of sensor shape:

≤ 1 % for an oblong shape

#### Battery:

9 V alkaline battery (NEDA 1604A, IEC 6LR61)

#### Battery life:

≥ 150 hrs continuous,  
≥ 1000 x 1 minute measurements

#### Low battery signal:

Green LED: battery OK

Flashing green LED: low battery

No green LED: battery discharged

#### Overload signal:

red LED

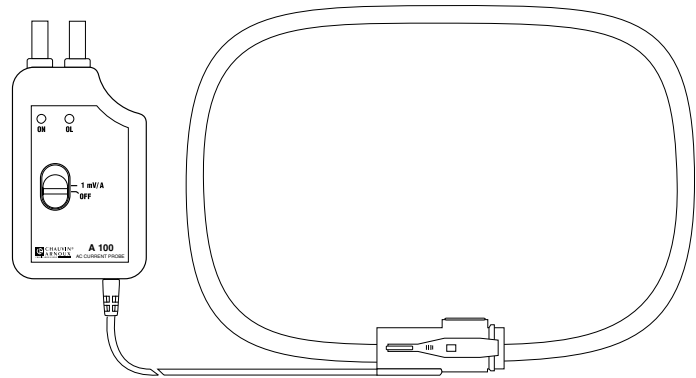

### ■ Mechanical specifications

#### Operating temperature:

-10 °C to +55 °C, (maximum temperature for sensor is 90 °C)

#### Storage temperature:

-40 °C to +70 °C

#### Influence of temperature:

≤ 0.5 % of output signal per 10 °K

#### Relative humidity for operation:

0 to 95 % RH with a linear decrease above 35 °C

#### Influence of relative humidity:

< 0.2 % of output signal from 10 % to 85 % RH

#### Operating altitude:

0 to 2,000 m

#### Casing protection rating:

Casing: IP40 (IEC 529)

Flexible sensor: IP65 (IEC 529)

#### Drop test:

1 m (IEC 68-2-32)

#### Shock resistance:

100 g (IEC 68-2-27)

#### Vibration resistance (IEC 68-2-6):

5/15/5 1.5 mm

15/25/15 1 mm

25/55/25 0.25 mm

#### Self-extinguishing capability:

Casing, flexible sensor and click-lock system:  
UL94 V0

#### Dimensions:

Casing: 140 x 64 x 28 mm (overall)

Connector lead: 2 m (connects sensor to casing)

Flexible sensor: Ø 12 mm ± 0.5 mm

#### Weight:

Casing: < 200 g

Flexible sensor: approx. 30 g per 10 cm length

#### Bending radius:

≥ 15 mm

#### Colours:

Casing and connection leads: dark grey, red flexible sensor with dark grey click-lock system

#### Output:

2 safety sockets (4 mm) spacing 19 mm

### ■ Safety specifications

#### Electrical safety:

Double insulation or reinforced insulation between primary, secondary and outer parts of casing liable to be handled, IEC 1010-1- 1000 V category III, pollution degree 2

#### Electromagnetic compatibility (EMC):

EN 50081-1: compliant

EN 50082-2:

- Electrostatic discharge: IEC 1000-4-2

- Radiated field: IEC 1000-4-3

- Fast transients: IEC 1000-4-4

- Electrical shocks: IEC 1000-4-5

- Magnetic field at 50/60 Hz: IEC 1000-4-8

(1) Conditions of reference: 23 °C ± 5 °K, 20 to 75 % RH, battery voltage: 9 V ± 0.5 V, external DC magnetic field < 40 A/m, no external magnetic or electrical field, conductor centred for measurement, sinusoidal signal: 10 ... 100 Hz.

To order	Reference
AmpFLEX™ 2000/2, length 45 cm with operating manual	P01120501
AmpFLEX™ 2000/2, length 80 cm with operating manual	P01120502

# Flexible probe for AC current

## Model A100 20-2000/2

AmpFLEX™ series

Current	200 A AC	2000 A AC
Output	10 mV/A	1 mV/A

### Electrical specifications

**Current calibres:**  
0.5 A AC ...200 A AC  
0.5 A AC ...2000 A AC

**Output signal:**  
10 mVAC/A AC (2 V for 200 A)  
1 mVAC/A AC (2 V for 2000 A)

**Accuracy (1):**

Calibre	200 A		2000 A	
	0.5 A...5 A	5 A...200 A	0.5 A...5 A	0.5 A...2000 A
Primary current	0.5 A...5 A	5 A...200 A	0.5 A...5 A	0.5 A...2000 A
% Accuracy of output signal	not specified	≤ 1 %	not specified	≤ 1 %
Phase shift	≤ 0.7°	≤ 0.7°	≤ 0.7°	≤ 0.7°

**Bandwidth:**  
10 Hz ...20 kHz

**Crest factor:**  
2.25 at rated current

**Max. current/Max. output voltage:**  
No current limit, but maximum output is 4.5 V peak

**Load impedance:**  
≥ 1 MΩ

**Influence of Z load impedance:**  
≤ 0.1 %/Z, (Z in MΩ)

**Output impedance:**  
1 kΩ

**DC voltage shift at output:**  
■ 200 A calibre: ≤ 5 mV DC  
■ 2000 A calibre: ≤ 2 mV DC

**Operating voltage:**  
1000 V rms

**Influence of adjacent conductor:**  
≤ 1 % interference current at 50 Hz  
(≤ 2 % near click-lock system)

**Influence of conductor position in loop:**  
≤ 1 % (≤ 4 % near click-lock system)

**Influence of sensor shape:**  
≤ 1 % for an oblong shape

**Battery:**  
9 V alkaline battery (NEDA 1604A, IEC 6LR61)

**Battery life:**  
≥ 150 hrs continuous,  
≥ 1000 x 1 minute measurements

**Low battery signal:**  
Green LED: battery OK  
Flashing green LED: low battery  
No green LED: battery discharged

**Overload signal:**  
Red LED

### Mechanical specifications

**Operating temperature:**  
-10 °C to +55 °C, (maximum temperature for sensor is 90 °C)

**Storage temperature:**  
-40 °C to +70 °C

**Influence of temperature:**  
≤ 0.5 % of output signal per 10 °K

**Relative humidity for operation:**  
0 to 95 % RH with a linear decrease above 35 °C

**Influence of relative humidity:**  
< 0.2 % of output signal from 10 % to 85 % RH

**Operating altitude:**  
0 to 2,000 m

**Casing protection rating:**  
Casing: IP40 (IEC 529)  
Flexible sensor: IP65 (IEC 529)

**Drop test:**  
1 m (IEC 68-2-32)

**Shock resistance:**  
100 g (IEC 68-2-27)

**Vibration resistance (IEC 68-2-6):**  
5/15/5 1.5 mm  
15/25/15 1 mm  
25/55/25 0.25 mm

**Self-extinguishing capability:**  
Casing, flexible sensor and click-lock system:  
UL94 V0

**Dimensions:**  
Casing: 140 x 64 x 28 mm (overall)  
Connector lead: 2 m (connects sensor to casing)  
Flexible sensor: Ø 12 mm ± 0.5 mm

**Weight:**

Casing: < 200 g  
Flexible sensor: approx. 30 g per 10 cm length

**Bending radius:**  
≥ 15 mm

**Colours:**  
Casing and connection leads: dark grey, red flexible sensor with dark grey click-lock system

**Output:**  
2 safety sockets (4 mm) spacing 19 mm

### Safety specifications

**Electrical safety:**  
Double insulation or reinforced insulation between primary, secondary and outer parts of casing liable to be handled, IEC 1010-1- 1000 V category III, pollution degree 2

**Electromagnetic compatibility (EMC):**  
EN 50081-1: compliant  
EN 50082-2:  
- Electrostatic discharge: IEC 1000-4-2  
- Radiated field: IEC 1000-4-3  
- Fast transients: IEC 1000-4-4  
- Electrical shocks: IEC 1000-4-5  
- Magnetic field at 50/60 Hz: IEC 1000-4-8

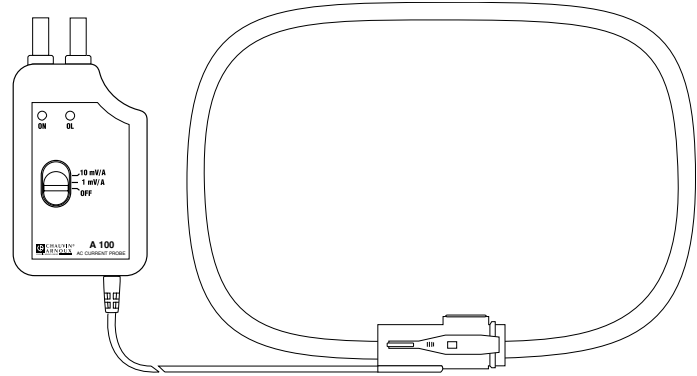

(1) Conditions of reference: 23 °C ± 5 °K, 20 % to 75 % RH, battery voltage: 9 V ± 0.5 V, external DC magnetic field < 40 A/m, no external magnetic or electrical field, conductor centred for measurement, sinusoidal signal: 10...100 Hz.

To order	Reference
AmpFLEX™ 200-2000/2, length 45 cm with operating manual	P01120504
AmpFLEX™ 200-2000/2, length 80 cm with operating manual	P01120505

# Flexible probe for AC current

## Model A100 300-3000 / 3

AmpFLEX™ series

Current	300 A AC	3000 A AC
Output	10 mV/A	1 mV/A

### Electrical specifications

#### Current calibres:

0.5 A AC ... 300 A AC

0.5 A AC ... 3000 A AC

#### Output signal:

10 mVAC/A AC (3 V for 300 A)

1 mVAC/A AC (3 V for 3000 A)

#### Accuracy <sup>(1)</sup>:

Calibre	300 A		3000 A	
	Primary current	0.5 A...5 A	5 A...300 A	0.5 A...5 A
% Accuracy of output signal	not specified	≤ 1 %	not specified	≤ 1 %
Phase shift	≤ 0.7°	≤ 0.7°	≤ 0.7°	≤ 0.7°

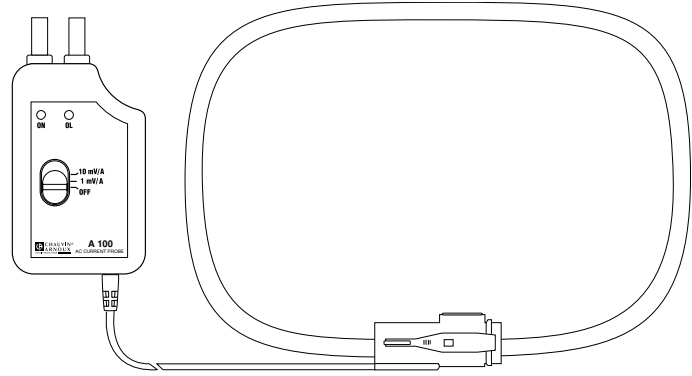

#### Bandwidth:

10 Hz ... 20 kHz

#### Crest factor:

1.5 at rated current

#### Max. current / Max. output voltage:

No current limit, but maximum output is 4.5 V peak

#### Load impedance:

≥ 1 MΩ

#### Influence of Z load impedance:

≤ 0.1 % / Z, (Z in MΩ)

#### Output impedance:

1 kΩ

#### DC voltage shift at output:

■ 300 A calibre: ≤ 5 mV DC

■ 3000 A calibre: ≤ 2 mV DC

#### Operating voltage:

1000 V rms

#### Common mode voltage:

600 V category III and pollution degree 2

#### Influence of adjacent conductor:

≤ 1 % interference current at 50 Hz

(≤ 2 % near click-lock system)

#### Influence of conductor position in loop:

≤ 1 % (≤ 4 % near click-lock system)

#### Influence of sensor shape:

≤ 1 % for an oblong shape

#### Battery:

9 V alkaline battery (NEDA 1604A, IEC 6LR61)

#### Battery life:

≥ 150 hrs continuous,

≥ 1000 x 1 minute measurements

#### Low battery signal:

Green LED: battery OK

Flashing green LED: low battery

No green LED: battery discharged

#### Overload signal:

Red LED

### Mechanical specifications

#### Operating temperature:

-10 °C to +55 °C, (maximum temperature for sensor is 90 °C)

#### Storage temperature:

-40 °C to +70 °C

#### Influence of temperature:

≤ 0.5 % of output signal per 10 °K

#### Relative humidity for operation:

0 to 95 % RH with a linear decrease above 35 °C

#### Influence of relative humidity:

< 0.2 % of output signal from 10 % to 85 % RH

#### Operating altitude:

0 to 2,000 m

#### Casing protection rating:

Casing: IP40 (IEC 529)

Flexible sensor: IP65 (IEC 529)

#### Drop test:

1 m (IEC 68-2-32)

#### Shock resistance:

100 g (IEC 68-2-27)

#### Vibration resistance:

5/15/5 1.5 mm

15/25/15 1 mm

25/55/25 0.25 mm

(IEC 68-2-6)

#### Self-extinguishing capability:

Casing, flexible sensor and click-lock system:

UL94 V0

#### Dimensions:

Casing: 140 x 64 x 28 mm (overall)

Connector lead: 2 m (connects sensor to casing)

Flexible sensor: Ø 12 mm ±0,5 mm

#### Weight:

Casing: < 200 g

Flexible sensor: 30 g per 10 cm length

#### Bending radius:

≥ 15 mm

#### Colours:

Case and connection leads: dark grey, red flexible sensor with dark grey click-lock system

#### Output:

2 safety sockets (4 mm) spacing 19 mm

### Safety specifications

#### Electrical safety:

Double insulation or reinforced insulation between primary, secondary and outer parts of casing liable to be handled, IEC 1010-1-1000 V category III, pollution degree 2

#### Electromagnetic compatibility (EMC):

EN 50081-1: compliant

EN 50082-2:

- Electrostatic discharge: IEC 1000-4-2

- Radiated field: IEC 1000-4-3

- Fast transients: IEC 1000-4-4

- Electrical shocks: IEC 1000-4-5

- Magnetic field at 50/60 Hz: IEC 1000-4-8

(1) Conditions of reference: 23 °C ± 5 °K, 20 % to 75 % RH, battery voltage: 9 V ± 0.5 V, external DC magnetic field < 40 A/m, no external magnetic or electrical field, conductor centred for measurement, sinusoidal signal: 10 ... 100 Hz.

To order	Reference
AmpFLEX™ 300-3000/3, length 45 cm with operating manual	P01120506
AmpFLEX™ 300-3000/3, length 80 cm with operating manual	P01120507
AmpFLEX™ 300-3000/3, length 120 cm with operating manual	P01120508

# Flexible probe for AC current

## Model A100 1000-10000/1

AmpFLEX™ series

Current	1000 AAC	10000 AAC
Output	1 mV/A	0.1 mV/A

### Electrical specifications

**Current calibres:**  
0.5 A AC ... 1000 A AC  
0.5 A AC ... 10000 A AC

**Output signal:**  
1 mVAC/A AC (1 V for 1000 A)  
0.1 mVAC/A AC (1 V for 10000 A)

**Accuracy <sup>(1)</sup>:**

Calibre	1000 A		10000 A	
	0.5 A...5 A	5 A...1000 A	0.5 A...50 A	0.5 A...10000 A
Primary current				
% Accuracy of output signal	not specified	≤ 1 %	not specified	≤ 1 %
Phase shift	≤ 0.5°	≤ 0.5°	≤ 0.5°	≤ 0.5°

**Bandwidth:**  
10 Hz ... [45 ... 65] ... 20 kHz

**Crest factor:**  
4.5 at rated current

**Max. current / Max. output voltage:**  
No current limit, but maximum output is 4.5 V peak.

**Load impedance:**  
≥ 1 MΩ

**Influence of Z load impedance:**  
≤ 0.1 %/Z, (Z in MΩ)

**Output impedance:**  
1 kΩ

**DC voltage shift at output:**  
■ 1000 A calibre: ≤ 2 mV DC  
■ 10000 A calibre: ≤ 1 mV DC

**Operating voltage:** 1000 V<sub>rms</sub>

**Influence of adjacent conductor:**  
≤ 1 % interference current at 50 Hz  
(≤ 2 % near click-lock system)

**Influence of conductor position in loop:**  
≤ 1 % (≤ 4 % near click-lock system)

**Influence of sensor shape:**  
≤ 1 % for an oblong shape

**Battery:**  
9 V alkaline battery (NEDA 1604A, IEC 6LR61)

**Battery life:**  
≥ 150 hrs continuous,  
≥ 1000 x 1 minute measurements

**Low battery signal:**  
Green LED: battery OK  
Flashing green LED: low battery  
No green LED: battery discharged

**Overload signal:**  
Red LED

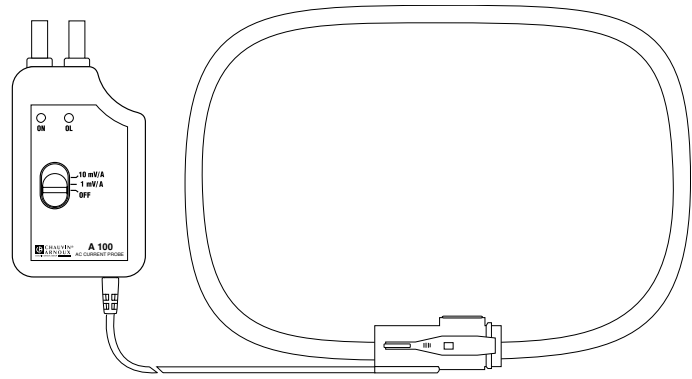

### Mechanical specifications

**Operating temperature:**  
-10 °C to +55 °C, (maximum temperature for sensor is 90 °C)

**Storage temperature:**  
-40 °C to +70 °C

**Influence of temperature:**  
≤ 0.5 % of output signal per 10 °K

**Relative humidity for operation:**  
0 to 95 % RH with a linear decrease above 35 °C

**Influence of relative humidity:**  
< 0.2 % of output signal from 10 % to 85 % RH

**Operating altitude:**  
0 to 2,000 m

**Casing protection rating:**  
Casing: IP40 (IEC 529)  
Flexible sensor: IP65 (IEC 529)

**Drop test:** 1 m (IEC 68-2-32)

**Shock resistance:**  
100 g (IEC 68-2-27)

**Vibration resistance:**  
5/15/5 1.5 mm  
15/25/15 1 mm  
25/55/25 0.25 mm  
(IEC 68-2-6)

**Self-extinguishing capability:**  
Casing, flexible sensor and click-lock system:  
UL94 V0

**Dimensions:**  
Casing: 140 x 64 x 28 mm (overall)  
Connector lead: 2 m (connects sensor to casing)  
Flexible sensor: Ø 12 mm ± 0.5 mm

**Weight:**

- Casing: < 200 g
- Flexible sensor: approx. 30 g per 10 cm length

**Bending radius:**  
≥ 15 mm

**Colours:**  
Casing and connection leads: dark grey,  
red flexible sensor with dark grey click-lock system

**Output:**  
2 safety sockets (4 mm) spacing 19 mm

### Safety specifications

**Electrical safety:**  
Double insulation or reinforced insulation between primary, secondary and outer parts of casing liable to be handled, IEC 1010-1- 1000 V category III, pollution degree 2

**Electromagnetic compatibility (EMC):**

- EN 50081-1: compliant
- EN 50082-2:
  - Electrostatic discharge: IEC 1000-4-2
  - Radiated field: IEC 1000-4-3
  - Fast transients: IEC 1000-4-4
  - Electrical shocks: IEC 1000-4-5
  - Magnetic field at 50/60 Hz: IEC 1000-4-8

(1) Conditions of reference: 23 °C ± 5 °K, 20 % to 75 % RH, battery voltage: 9 V ± 0.5 V, external DC magnetic field < 40 A/m, no external magnetic or electrical field, conductor centred for measurement, sinusoidal signal: 10 ... 100 Hz.

To order	Reference
AmpFLEX™ 1000-10000/1, length 120 cm with operating manual	P01120509



# Flexible probe for AC current

## Model A100 on request

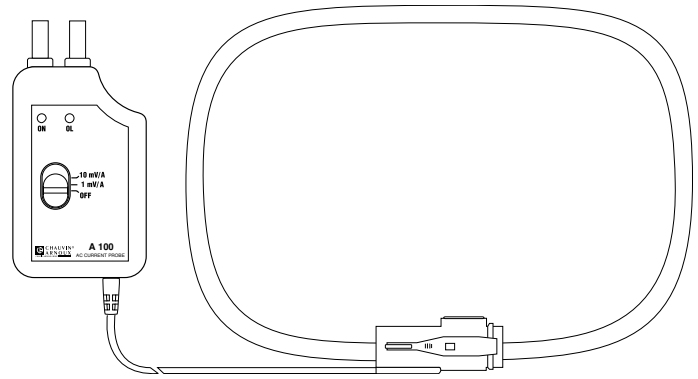

To complete the comprehensive range of standard models presented on the preceding pages, Chauvin Arnoux also offers to make special models to meet your particular needs.

In this way it is possible to define AmpFLEX™ flexible current sensors with sensitivities and lengths corresponding to your applications.

To do so, it is necessary to give a reference as follows:

**A 1 0 0**   **A**   **B B B**   **C C C**   **D D D**

with:

A : Number of ranges

BBB : Max. range value, in Amperes

CCC : Max. range sensitivity in mV/A

DDD : Length of flexible sensor in cm (min X 40 = 40 cm, max = 990 cm) for a section of 10 cm

### Currently available values:

Model	A 1 0 0	A	B B B	C C C	D D D
20-200 A/2 V	A 1 0 0	2	2 0 0	X 1 0	
2000 A/2 V	A 1 0 0	1	2 K 0	X X 1	
200-2000 A/2 V	A 1 0 0	2	2 K 0	X X 1	
300-3000 A/3 V	A 1 0 0	2	3 K 0	X X 1	
1000-10000 A/1 V	A 1 0 0	2	1 0 K	0 . 1	

### Example 1:

An AmpFLEX™ A100 flexible sensor, with 2 ranges 200-2000 A and length 5 m would be represented by:

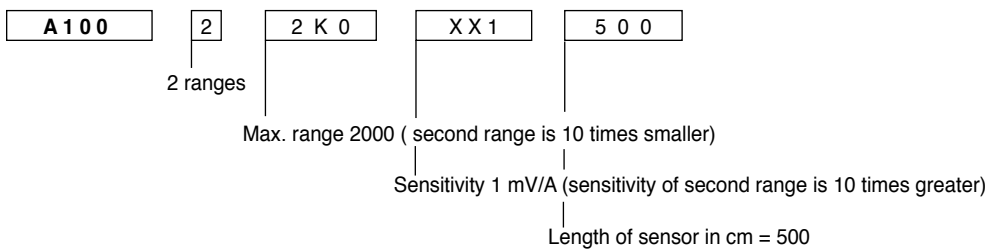

### Example 2:

An AmpFLEX™ flexible sensor, range 2000 A, length 90 cm would be represented by:

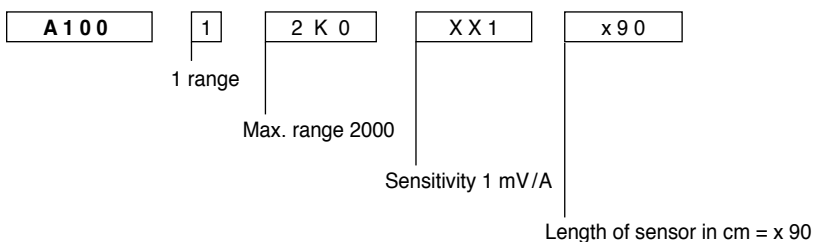

As Chauvin Arnoux is always seeking to improve its products, do not hesitate to contact us for other configurations.

# Flexible probe for AC current

## Model A101

AmpFLEX™ series

### ⚠ CAUTION

These products are only offered under certain conditions (quantity, etc.) to manufacturers of measurement, location and detection instruments.

The AmpFLEX™ offers perfect linearity, low phase shift, a wide range of measurements (up to several kA) and unrivalled ease of use. The A101 series is Chauvin Arnoux's response to all the measurement instrument manufacturers wishing to integrate AmpFLEX™ solutions into their product lines.

### ■ Description

The A101 AmpFLEX™ sensor is composed of an active element (Rogowski coil) and a connection lead. It is necessary to add on an electronic processing system (not included), in order to complete this measurement device.

Chauvin Arnoux has added an extra step to the manufacturing process of the A101 probe which guarantees their interchangeability. This is essential in applications such as three-phase measurements where several identical probes are used.

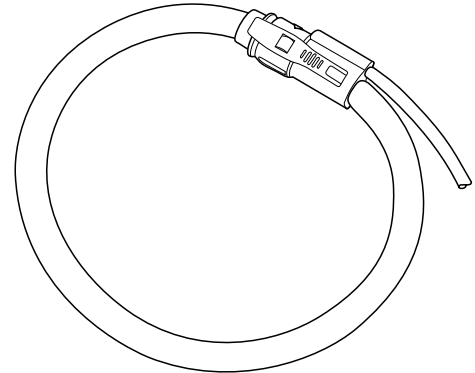

### ■ Electrical specifications

#### Voltage at sensor terminals:

46  $\mu\text{V}/\text{A}$  (-15 % ... +10 %) at 50 Hz

#### Linearity\*:

< 0.3 %

#### Phase shift\*:

$\leq 0.5^\circ$  at 50 Hz

#### Interchangeability error:

$\leq 0.5$  % (maximum error between 2 sensors for the same measurement point).

#### Frequency range:

Depends on the electronics with which it is used.

#### Operating voltage:

1000 V rms or DC

### ■ Mechanical specifications

#### Operating temperature:

-20 °C to +60 °C

#### Storage temperature:

-0 °C to +80 °C

#### Max temperature of measured cable:

$\leq 90$  °C

#### Operating altitude:

0 to 2,000 m

#### Maximum conductor size:

Depending on sensor length.

#### Casing protection rating:

IP65 in accordance with EN 60529

#### Self-extinguishing capability:

External cover, click-lock system, connection lead: UL94 V0

#### Dimensions:

$\varnothing$  of sensor: 12 mm

#### Weight:

Approx. 30 g per 10 cm length

#### Colour:

Sensor: red

Click-lock system: dark grey

#### Output:

According to configuration (refer to § Connections)

#### Connexions:

According to configuration (refer to § Connections)

### ■ Safety specifications

#### Electrical safety:

Double insulation or reinforced insulation between primary, secondary and outer parts of casing liable to be handled, IEC 1010-1 & IEC 1010-2-032, 1000 V category III, pollution degree 2

#### Electromagnetic compatibility (EMC):

EN 50081-1: class B

EN 50082-2:

- Electrostatic discharge: IEC 61000-4-2
- Radiated field: IEC 61000-4-3
- Fast transients: IEC 61000-4-4
- Magnetic field at 50/60 Hz: IEC 61000-4-8

\* Conditions of reference: 23 °C  $\pm$  6 K, 20 % to 75 % RH, frequency 10 Hz to 100 Hz, sinusoidal signal, no external AC magnetic field, external magnetic field  $\leq 40$  A/m (earth field), conductor centred for measurement.

# Flexible probe for AC current

## Model A101

AmpFLEX™ series

### ■ Configurations

Level 1

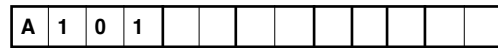

- **Category** (fixed field)
- **Lead length in decimetres**
  - Min value: **05** (50 cm)
  - Max value: **99** (9.9 m)
  - Increment per 1 dm section (10 cm)
- **Length of connection lead in decimetres**
  - Min value: **05** (50 cm)
  - Max value: **99** (9.9 m)
  - Increment per section of 1 dm (10 cm)
- **Measurement range** (refer to additional information)
 

0: without	2: electronic diagram CA2
1: electronic diagram CA1 or C.A 833X and C.A 823X	3: electronic diagram CA3
	4: diagram suited for C.A 8310
- **Connections**
  - X: lead without connection unit
  - C: specific lead
- **Calibration for interchangeability** (refer to additional information)
  - N: without
  - O: with
- **Special feature**
  - X1: plain sensor without CHAUVIN ARNOUX logo, with standard and AmpFLEX™ inscriptions, plain packing with instruction manual
  - X2: plain sensor without CHAUVIN ARNOUX logo, with standard and AmpFLEX™ inscriptions, plastic bag packing, instruction manual stapled on the plastic bag
  - C1: same as CHAUVIN ARNOUX sensor plain packing box with instruction manual
  - C2: same as CHAUVIN ARNOUX sensor plastic bag packing, instruction manual stapled on the plastic bag

Level 2



- **Connections** (refer to additional information)
  - XXX1: circular lead 2 conductors + bare and tinned
  - BNC1: coaxial lead + insulated coaxial plug
  - FRB1: circular lead 2 conductors + screening with FRB connector  
D01 model, type 1 (male pins)
  - FRB2: circular lead 2 conductors + screening with FRB connector  
D01 model, type 2 (sockets)
  - 833X: specific connections for Qualistar C.A 833X and C.A 823X
- **Colour of connector** (refer to additional information)
 

XX : no connector	GN: green
BK: black	WH: white
RD: red	YE: yellow
BU: blue	
- **+ connection point**
  - 1, 2 or 3: contact N° connected to +
  - X: no connector
  - : for 833X and 823X connection: not concerned
- **- connection point**
  - 1, 2 or 3: contact N° connected to -
  - X: no connector
  - : for 833X and 823X connection: not concerned
- **Connected protection**
  - 1, 2 or 3: contact N° connected to screening
  - X: not connected or no connector
  - : for 833X and 823X connection: not concerned
- **Interchangeability resistors** (refer to additional information)
  - I: included in sensor
  - F: resistors supplied
  - D: values are indicated in the manual included with AmpFLEX™ (resistors not supplied)
  - X: no calibration for interchangeability

# Flexible probe for AC current

## Model A101

AmpFLEX™ series

### ■ Specific configuration of sensors for C.A 8310 Power & Harmonics Analyser

To complete the range of standard sensors for this product, A190 sensors of different lengths can be used (the A190 is simply a specific type of A101).

Select:

Level 1	A	1	0	1					4	C	O	C	1
Level 2	F	R	B	1					1	3	X	I	

Blank spaces refer to:

- level 1: sensor lengths and connection lead to be chosen
- level 2: colour of connector

### ■ Additional information

#### ■ Measurement range (electronic diagram)

Choosing the measurement range depends on the sensitivity required and on electronic supply voltages.

Example:

For a supply voltage of  $\pm 5$  V, electronic output voltage will be limited to  $\pm 4.5$  V peak to peak, that is to say approximately 3 V RMS ( $4.5 \text{ V} / \sqrt{2}$ ) if measured signal is sinusoidal.

The different diagrams refer to sensitivity ranges in accordance with the following chart:

Diagram	CA1	CA2	CA3
Sensitivity	0.1 mV/A...1 mV/A	1 mV/A...10 mV/A	10 mV/A...100 mV/A
Max. measurement range for a $\pm 5$ V supply	3000 A...30000 A	300 A...3000 A	30 A...300 A
Max. measurement range for a $\pm 15$ V supply	9000 A...90000 A	900 A...9000 A	90 A...900 A

#### ■ Interchangeability calibration

For applications that require the use of several sensors, it is necessary to ensure that all the sensors used on a single measuring instrument have identical output specifications.

Calibration is carried out for a standard electronic circuit (refer to following chart) at input level (integrator).

#### Associated electronics

This uses the standard diagrams of the input stage, corresponding to the different measurement ranges required.

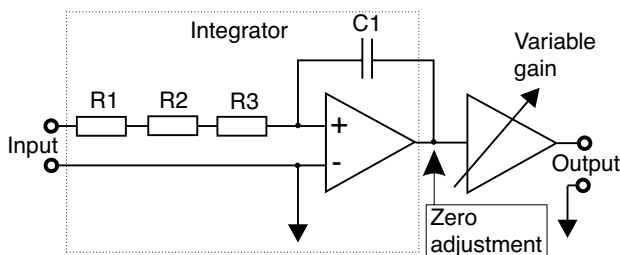

#### Values of integrator's resistors and capacitor according to sensitivity.

Diagram	CA1	CA2	CA3
Sensitivity	0.1 mV/A...1 mV/A	1 mV/A...10 mV/A	10 mV/A...100 mV/A
C1	100 nF	10 nF	1 nF
R1 = R2 = R3	4.12 k $\Omega$		

C1 preferably in polycarbonate (tolerance 5 %).

R1, R2 and R3 metallic coating, tolerance 1 %, power 1/8 W temperature coefficient 50 ppm.





Standard technology or SMD.

# Flexible probe for AC current

## Model A101

AmpFLEX™ series

### ■ Connection

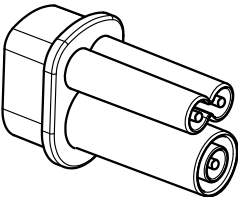
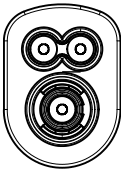
Connector	Choice of connections	Colour of the connector
<b>BNC1</b> Coaxial leads + insulated coaxial plug 		BK: black RD: red <sup>(1)</sup> BU: blue <sup>(1)</sup>
<b>FRB1:</b> FRB D01 model Contact: male  <b>FRB2:</b> FRB D01 model Contact: female 		BK: black RD: red BU: blue GN: green <sup>(1)</sup> WH: white YE: yellow <sup>(1)</sup>
<b>Connection for C.A 833x models:</b> IEC 61010 		BK: black RD: red BU: blue GN: green YE: yellow

(1) colour not in stock

### ■ Interchangeability resistors

In order to enable interchangeability of sensors, the calibration process involves defining the value of a resistor which will be inserted in the measurement circuit.

In fact, these resistors can be integrated into connectors FRB1 or FRB2.

Contact us for details of other types of connectors.

To order	Reference
<b>A101 AmpFLEX</b> without electronic unit Accessories: "Black" click-on adapters (set of 10)	<b>Contact us</b>  P01101924



## K series

The K series is a new product range with exceptional measurement capabilities.

Extremely compact in design, these “micro-probes” are designed for highly accurate measurement of very low currents.

Their small dimensions and shape make them ideal for probing into tight spaces where access is limited, as is the case on most switchboards, 4-20 A process loops or vehicle wiring looms for example.

These “K” series current probes make excellent work companions for multimeters and any other instrument able to make use of their high sensitivity, dynamic range and ability to indicate the shapes of signals and waveforms.

They give an AC+DC output signal that is proportional to the measured current, without needing to change the range or filter the signal. RMS measurements are possible with DC+AC components.

There are two different types of K series current probes available.

Model K1 gives a 1 mV/mA output and lends itself to a variety of different applications, oriented towards low-current measurement.

Model K2 has a greater level of sensitivity with its 10 mV/mA output.

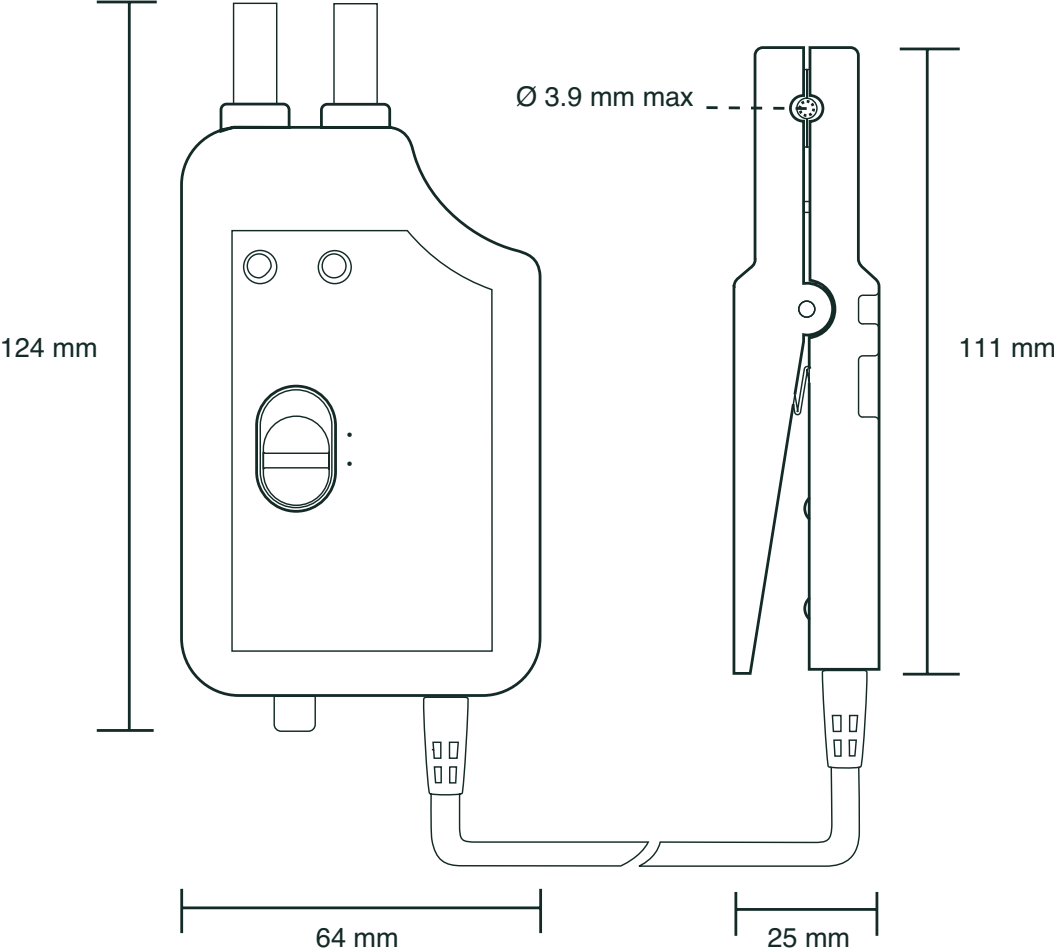

# AC/DC current probe

## Model K1

K series

<b>Current</b>	4500 mA DC 3000 mA AC
<b>Output</b>	1 mV/mA

### Description

The K1 model measures currents as low as 100  $\mu$ A AC or DC.  
The clamp provides a proportional output signal enabling direct readings on multimeters.

### Electrical specifications

#### Current calibres:

1 mA DC... $\pm$ 4.5 A DC  
1 mA rms...3 A rms (sinusoidal)  
1 mA...4.5 A peak, square and steps

**Output (output voltage):** 1 mV/mA

#### Resolution:

DC: 50  $\mu$ A typical  
AC: 100  $\mu$ A typical

#### Accuracy <sup>(1)</sup>:

##### DC current

Primary current	1 mA...10 mA	10 mA...120 mA	120 mA...4500 mA
Accuracy in % of output signal	2 % $\pm$ 0.2 mV	2 % $\pm$ 0.1 mV	1 %

##### AC current from 45 Hz to 65 Hz

Primary current	1 mA...10 mA	10 mA...120 mA	120 mA...3000 mA
Accuracy in % of output signal	3 % $\pm$ 0.3 mV	3 % $\pm$ 0.1 mV	1 %

#### Frequency response:

DC to 2kHz (to -3 dB)

#### Load impedance:

$\geq$  1 M $\Omega$  and  $\leq$  100 pF

#### Output noise:

< 100  $\mu$ V, DC to 3 kHz

#### Output impedance:

220  $\Omega$

#### Inductance of clamp:

< 1  $\mu$ H

#### Rise time:

< 200  $\mu$ s, 10 % to 90 %

#### Fall time:

< 200  $\mu$ s, 90 % to 10 %

#### Influence of adjacent conductors

(50 Hz at 23 mm from the clamp):  
< 100  $\mu$ A/A

#### Influence of earth field:

< 120  $\mu$ A

#### Battery:

Alkaline 9 V, NEDA 1604,  
6LR61 or IEC 6 LF22

#### Battery level indication:

Green LED when battery voltage > 6.5 V

#### Battery charge life:

Approximately 20 hours

#### Overload indication:

Red LED indicating momentary or continuous overload

#### Max. current:

200 A AC or DC with current limitation according to with frequency, above 400 Hz

### Mechanical specifications

#### Operating temperature:

-10  $^{\circ}$ C to +55  $^{\circ}$ C

#### Storage temperature:

-40  $^{\circ}$ C to +80  $^{\circ}$ C

#### Influence of temperature:

< 1000 ppm/ $^{\circ}$ K or 1 %/10  $^{\circ}$ C

#### Humidity:

< 95 % for < 35  $^{\circ}$ C, 75 % at +55  $^{\circ}$ C

#### Operating altitude:

0 to 2,000 m

#### Adjustment of DC zero:

approximately  $\pm$ 25 mA by turning the button on the bottom of the housing

#### Max. jaw insertion capacity:

$\varnothing$  3.9 mm

#### Protection rating:

IP 40 in accordance with IEC 529

#### Drop test:

1.0 m in accordance with IEC 68-2-32

#### Impacts:

100 g in accordance with IEC 68-2-27

#### Vibration:

in accordance with IEC 68-2-6

#### Frequency range:

5 to 15 Hz, amplitude: 1.5 mm  
15 to 25 Hz: amplitude: 1 mm  
25 to 55 Hz: amplitude: 0.25 mm

#### Dimensions:

Electronic module: 124 x 64 x 28 mm  
Probe: 111 x 15 x 25 mm

#### Cable length:

1.5 m

#### Weight:

250 g

#### Colour:

Dark grey

#### Output:

Two 4 mm safety terminals 19 mm apart.

### Safety specifications

#### Operating voltage:

300 V in accordance with IEC 1010-1 Cat. II

#### Electromagnetic compatibility:

Immunity (EN 50082-1): class A  
DC: 15 mV for 0  
AC (60 Hz): 2 dB from 10 mA...4.5 A  
Emissivity (EN 50081-1): negligible

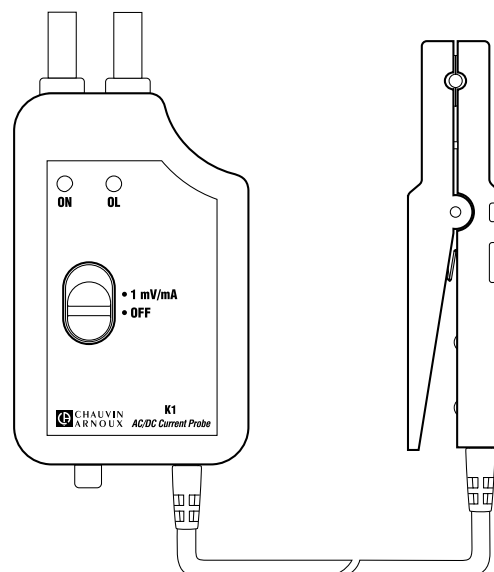

(1) Conditions of reference: 23  $^{\circ}$ C  $\pm$  3  $^{\circ}$ C, 20 % to 75 % RH, batteries 9 V  $\pm$  0.1 V, earth's magnetic field < 40 A/m, no AC field, DC or sinusoidal current from 45 Hz to 65 Hz

To order	Reference
AC/DC current clamp model <b>K1</b> in carrying case with battery and user's manual	P01120067A



# AC/DC current probe

## Model K2

K series

<b>Current</b>	450 mA DC 300 mA AC
<b>Output</b>	10 mV/mA

### Description

The K2 model measures currents as low as 100  $\mu$ A AC or DC.  
The probe has a proportional output for direct readings on multimeters.

### Electrical specifications

#### Current calibres:

0.1 mA DC... $\pm$  450 mA DC  
0.1 mA rms...300 mA rms (sinusoidal)  
0.1 mA peak...450 mA peak, square signal and steps

#### Output (output voltage):

10 mV/mA

#### Resolution:

DC: 50  $\mu$ A typical  
AC: 100  $\mu$ A typical

#### Accuracy <sup>(1)</sup>:

##### DC current

Primary current	0.1 mA...1 mA	1 mA...12 mA	12 mA...450 mA
Accuracy in % of output signal	3 % $\pm$ 2 mV	2 % $\pm$ 2 mV	1 %

##### AC current from 45 Hz to 65 Hz

Primary current	0.1 mA...1 mA	1 mA...12 mA	12 mA...300 mA
Accuracy in % of output signal	3 % $\pm$ 0.5 mV	2 % $\pm$ 0.5 mV	1 %

#### Frequency response:

DC to 1.5 kHz (to -3 dB)

#### Load impedance:

$\geq$  1 M $\Omega$  and  $\leq$  100 pF

#### Output noise:

< 100  $\mu$ V DC to 1.5 kHz

#### Output impedance:

200  $\Omega$

#### Inductance of clamp:

< 1  $\mu$ H

#### Rise time:

< 200  $\mu$ s, 10 % to 90 %

#### Fall time:

< 200  $\mu$ s, 90 % to 10 %

#### Influence of adjacent conductors:

(50 Hz at 23 mm from the clamp):  
< 100  $\mu$ A /A

#### Influence of earth field:

< 120  $\mu$ A, 0...max

#### Battery:

Alkaline 9 V, NEDA 1604, 6LR61  
or IEC 6 LF22

#### Battery level indication:

Green LED when battery voltage > 6.5 V

#### Battery charge life:

Approximately 20 hours

#### Overload indication:

Red LED indicating momentary or continuous overload

#### Max. current:

100 A AC rms or DC with current limitation  
according to with frequency, above 800 Hz

### Mechanical specifications

#### Operating temperature:

-10  $^{\circ}$ C to +55  $^{\circ}$ C

#### Storage temperature:

-40  $^{\circ}$ C to +80  $^{\circ}$ C

#### Influence of temperature:

< 500 ppm/ $^{\circ}$ K or 0.5 % / 10  $^{\circ}$ C

#### Humidity:

< 95 % at < 35  $^{\circ}$ C, 75 % at 55  $^{\circ}$ C

#### Operating altitude:

0 to 2,000 m

#### Adjustment of DC zero:

approximately  $\pm$ 15 mA by turning the button  
on the bottom of the housing (10 turns)

#### Max. jaw insertion capacity:

$\varnothing$  3.9 mm

#### Protection rating:

IP40 in accordance with IEC 529

#### Drop test:

1.0 m in accordance with IEC 68-2-32

#### Impacts:

100 g in accordance with IEC 68-2-27

#### Vibration:

in accordance with IEC 68-2-6

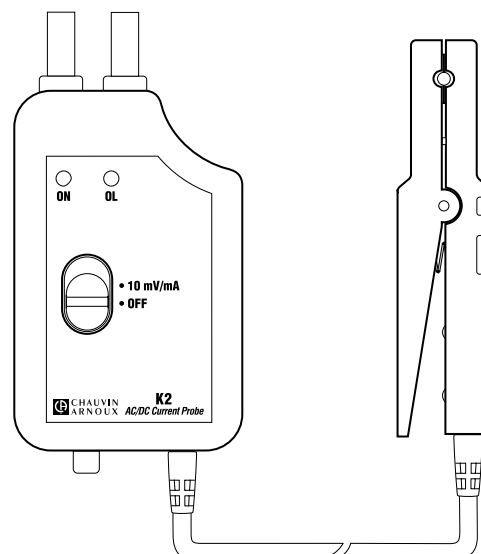

#### Frequency range:

5 Hz...15 Hz, amplitude: 1.5 mm  
15 Hz...25 Hz: amplitude: 1 mm  
25 Hz...55 Hz: amplitude: 0.25 mm

#### Dimensions (electronic module):

124 x 64 x 28 mm

#### Dimension (probe):

111 x 15 x 25 mm

#### Cable length:

1.5 m

#### Weight:

250 g

#### Colour:

Dark grey

#### Output:

Two 4 mm safety terminals 19 mm apart.  
(standard)

### Safety specifications

#### Operating voltage:

300 V in accordance with IEC 1010-1 Cat. II

#### Electromagnetic compatibility:

Immunity (EN 50082-1): class A  
DC: 15 mV for 0  
AC (60 Hz): 2 dB from 10 mA...4.5 A  
Emissivity (EN 50081-1): negligible

(1) Conditions of reference: 23  $^{\circ}$ C  $\pm$  3  $^{\circ}$ C, 20  $^{\circ}$ C to 75 % RH, batteries 9 V  $\pm$  0.1 V, earth's magnetic field < 40 A/m, no AC field, DC or sinusoidal current from 45 Hz to 65 Hz

To order	Reference
AC/DC current clamp model K2 in carrying case with battery and user's manual	P01120074A



## **E<sub>N</sub> series**

The E<sub>N</sub> series clamps use Hall-effect technology for the measurement of AC and DC currents from several milliamps to over 100 A.

These clamps' narrow, elongated design makes them ideal for measurements in cable bundles or in other confined areas like circuit boards, motor controls or motor vehicle electrical circuits.

Their low phase shifting also ensures excellent performance for power measurements.

These clamps have a voltage output (mv) and their ability to measure AC and DC signals is useful for true RMS measurements.

Model E6N is the most sensitive for low current measurements.

The E series clamps all make excellent work mates for multimeters, recorders and logging equipment, etc. Model E3N can even be connected directly to an oscilloscope.

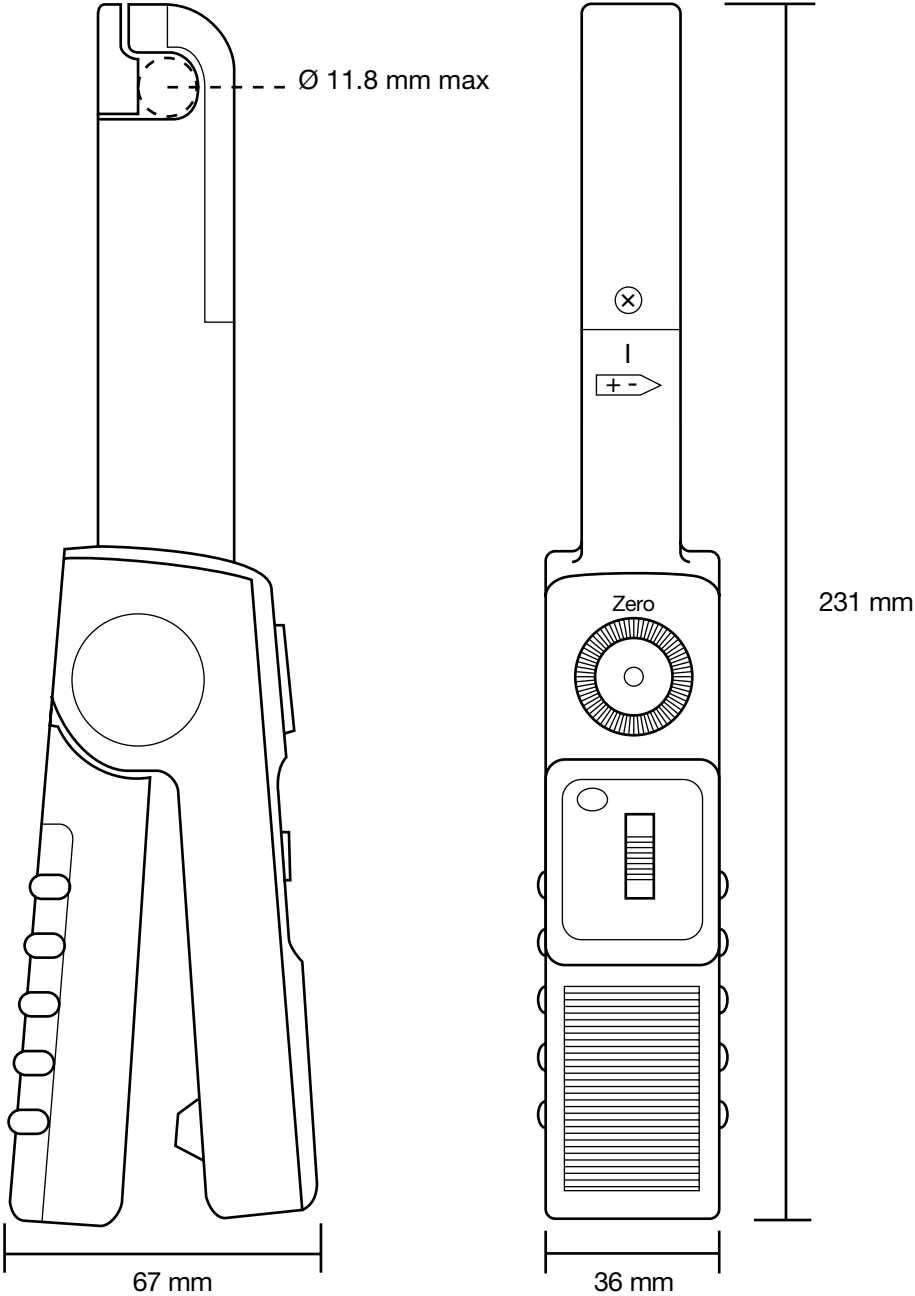

# AC/DC current clamp

## Model E1N

EN series

<b>Current</b>	2 A AC/DC	150 A AC/DC
<b>Output</b>	1 mV/mA	1 mV/A

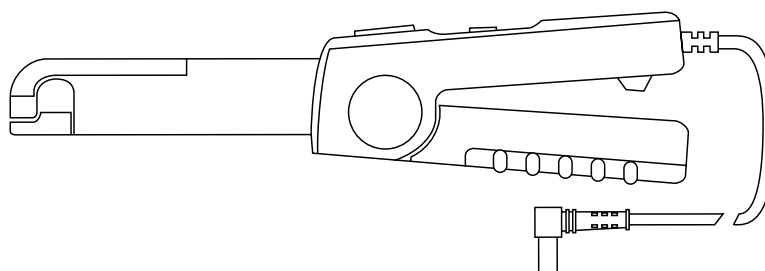

### Electrical specifications

**Current range:**

50 mA...150 A AC/DC over two calibres

**Output signal:**

1 mV/mA and 1 mV/A AC or DC

**Accuracy and phase shift <sup>(1)</sup>:**

Calibre	1 mV/mA (1 V/A)	1 mV/A
Current range	50 mA...2 A DC 50 mA...1.5 AAC	500 mA...150 A
Accuracy in % of output signal	2% ± 20 mV	500 mA...100 A AC/DC: 1.5% ± 30 µV 100 A...150 A DC: 3% 100 A...120 A AC: 3%
Frequency range	DC...65 Hz: 3°	DC...65 Hz: 1°
Phase shift	not specified	not specified
Min load impedance	≥ 10 kΩ	≥ 2 kΩ
Noise	DC...1 Hz: 3 mV 1 Hz...10 kHz: 10 mV 10 kHz...100 kHz: 18 mV	DC...1 Hz: 3 µV 1 Hz...10 kHz: 10 µV 10 kHz...100 kHz: 18 µV

**Operating voltage:**

600 V rms max

**Common mode voltage:**

600 V rms max

**Battery:**

9 V alkaline (NEDA 1604A, IEC 6LR61)

**Battery life:**

70 hours typical

**Typical consumption:**

6 mA

**Battery level indicator:**

Green LED when > 6.5 V

### Mechanical specifications

**Operating temperature:**

0° to +50 °C

**Storage temperature:**

-30 °C to +80 °C

**Influence of temperature:**

< 0.2 % per °C

**Relative humidity for operation:**

+10 °C to +30 °C:

85 ± 5 % RH (without condensation)

+40 °C to +50 °C:

45 ± 5 % RH (without condensation)

**Operating altitude:**

0 to 2,000 m

**Max. jaw insertion capacity:**

11.8 mm

**Zero adjustment:**

20 turn potentiometer (± 1.5 A min)

**Drop test:**

1 m on a 38 mm container of oak on concrete, test in accordance with IEC 1010

**Shock resistance:**

100 g, in accordance with IEC 68-2-27

**Vibration resistance:**

10/55/10 Hz, 0.15 mm  
test in accordance with IEC 68-2-6

**Casing protection rating:**

IP20 in accordance with IEC 529

**Self-extinguishing capability:**

Casing: UL94 V2

**Dimensions:**

231 x 36 x 67 mm

**Weight:**

330 g with batteries

**Colour:**

Dark grey

**Output:**

1.5 m two-wire lead with double or reinforced insulation terminated by 2 elbowed male safety plugs (4 mm)

### Safety specifications

**Electrical safety:**

600 V category III, pollution 2

300 V category IV, pollution 2

**Electromagnetic compatibility (EMC):**

EN 50081-1: class B

EN 50082-2:

- Electrical discharge IEC 1000-4-2

- Radial field IEC 1000-4-3

- Fast transients IEC 1000-4-4

- Magnetic field at 50/60 Hz IEC 1000-4-8

(1) Conditions of reference: 23 °C ±5 °K, 20 to 75 % RH, 48 to 65 Hz, external magnetic field < 40 A/m, no current-carrying conductor nearby, centred test sample, load impedance 1 MΩ

To order	Reference
AC/DC current clamp model E1N with battery and user's manual	P01120030A

## Model E3N (insulated AC/DC current probe)

<b>Current</b>	10 A peak	100 A peak
<b>Output</b>	100 mV/A	10 mV/A

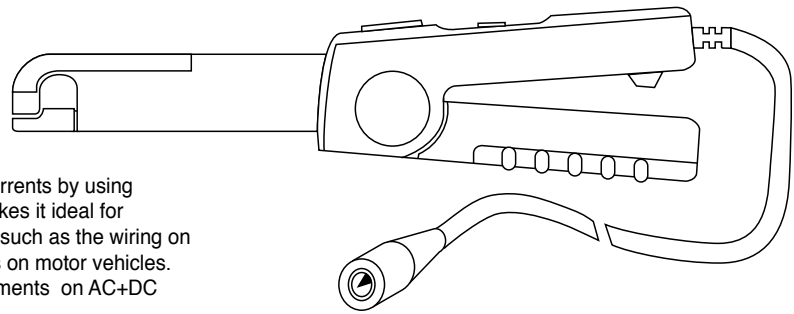

### Description

The E3N clamp is designed to measure AC and DC currents by using Hall-effect technology. Its narrow, elongated shape makes it ideal for measurements in cable bundles or in confined spaces such as the wiring on switchboards, motor control units and electrical circuits on motor vehicles. It is particularly appreciated for its True RMS measurements on AC+DC signals. It offers 2 different sensitivities.

### Electrical specifications

#### Current calibres:

0.1 A ... 10 A peak  
0.5 A ... 100 A peak

#### Output signal:

100 mV AC+DC / A AC+DC (1 V for 10 A)  
10 mV AC+DC / A AC+DC (1 V for 100 A)

#### Accuracy and phase shift <sup>(1)</sup>:

Calibre	10 A	100 A	
Current range	100 mA...10 A peak	500 mA...40 A peak	40 A...100 A peak
Accuracy in % of output signal	≤ 3 % + 5 mV	≤ 4 % + 500 μV	≤ 15 %
Phase shift	≤ 1.5°	≤ 1°	≤ 1°

#### Bandwidth:

DC...100 kHz (-3 dB) (depending on current value)

#### Rise/fall time from 10 % to 90 %:

- 10 A calibre: 3 μs
- 100 A calibre: 4 μs

#### 10 % delay time:

- 10 A calibre: 2.7 μs
- 100 A calibre: 1.8 μs

#### Insertion impedance (at 10 kHz / 50 kHz):

< 1.3 mΩ / < 10 mΩ

#### DC zero adjustment:

20 turns of potentiometer

#### Typical output noise level (peak-peak) from DC to 100 kHz:

- 10 A calibre: 6 mV
- 100 A calibre: 600 μV

#### Battery:

9 V alkaline (NEDA 1604A, IEC 6LR61)

#### Battery life:

55 hours typical

#### Typical consumption:

8.6 mA typical / 12 mA max.

#### Battery level indicator:

Green LED when > 6.5 V

#### Overload indicator:

Red LED indicates the measured current is too high for the selected range

#### Influence of temperature:

≤ 2000 ppm / °C

#### Influence of conductor position in jaws:

≤ 0.5 % of output signal at 1 kHz

#### Common mode voltage (600 V max) for AC measurements (typical / max):

- 10 A calibre:  
at 50 Hz: 3.48 mA/100 V / 5 mA/100 V  
at 400 Hz: 25.91 mA/100 V / 50 mA/100 V
- 100 A calibre: not measurable

### Mechanical specifications

#### Clamping capacity:

Cable: Ø max 11.8 mm

#### Output:

Via 2 m coaxial cable terminated by BNC insulated plug.

#### Dimensions:

231 x 67 x 36 mm

#### Weight:

330 g with battery

#### Operating temperature:

0° to +50 °C

#### Storage temperature:

-30 °C to +80 °C

#### Relative humidity for operation:

0 to 85 % RH with a linear decrease above 35°C

#### Operating altitude:

0 to 2,000 m

#### Casing protection rating:

IP20 (IEC 529)

#### Drop test:

1 m (IEC 68-2-32)

#### Shock resistance:

100 g / 6 ms / half-period (IEC 68-2-27)

#### Vibration resistance:

10/55/10 Hz, 0.15 mm (IEC 68-2-6)

#### Self-extinguishing capability:

UL94 V2

#### Colour:

Dark grey

### Safety specifications

#### Electrical safety:

Instrument with double insulation or reinforced insulation between the primary, the secondary and the grippable part located under the guard as per IEC 1010-1 & IEC 1010-2-032

- 600 V category III, pollution degree 2
- 300 V category IV, pollution degree 2

#### Electromagnetic compatibility (EMC):

EN 50081-1: class B

EN 50082-2:

- Electrostatic discharge IEC 1000-4-2:

- Fast transients IEC 1000-4-4:

1 kV level 2 performance criterion B

2 kV level 3 performance criterion B

- Magnetic field at the network frequency (IEC 1000-4-8):

field of 400 A/m at 50 Hz: < 1 A

## Model E3N (insulated AC/DC current probe)

### ■ Curves

*100 A calibre*

Linearity with DC

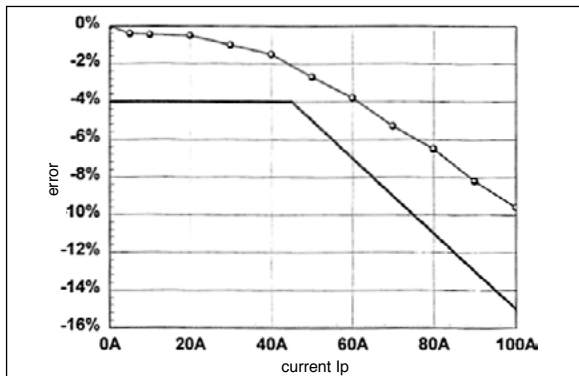

Frequency response

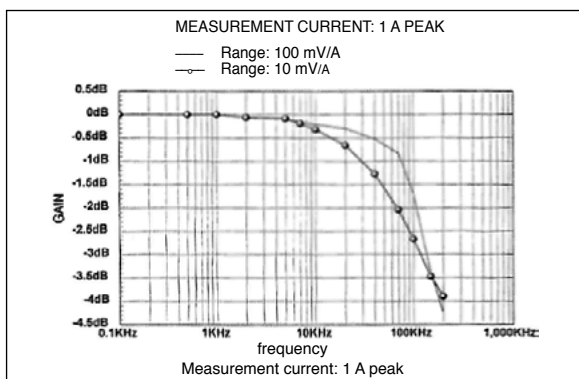

Phase shift

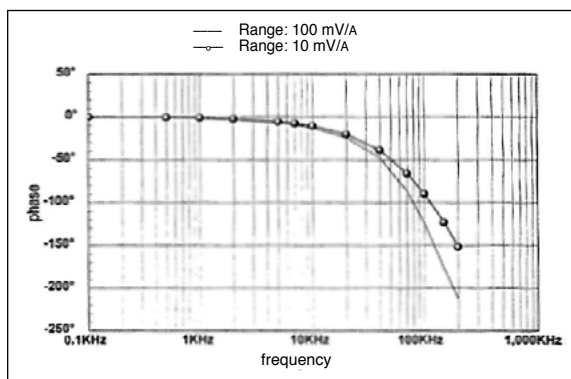

Immunity regarding an external conductor

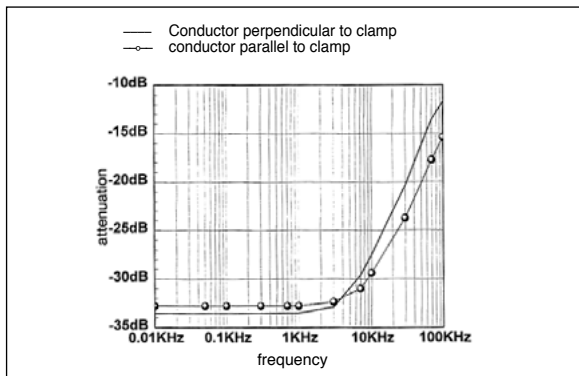

Limitation of measurable current according to the frequency

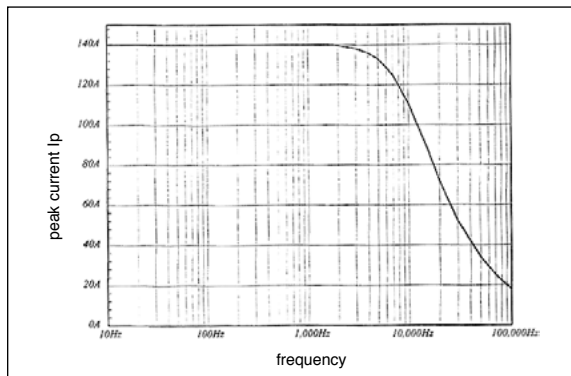

## Model E3N (insulated AC/DC current probe)

### ■ Curves

*100 A calibre*

1 A peak

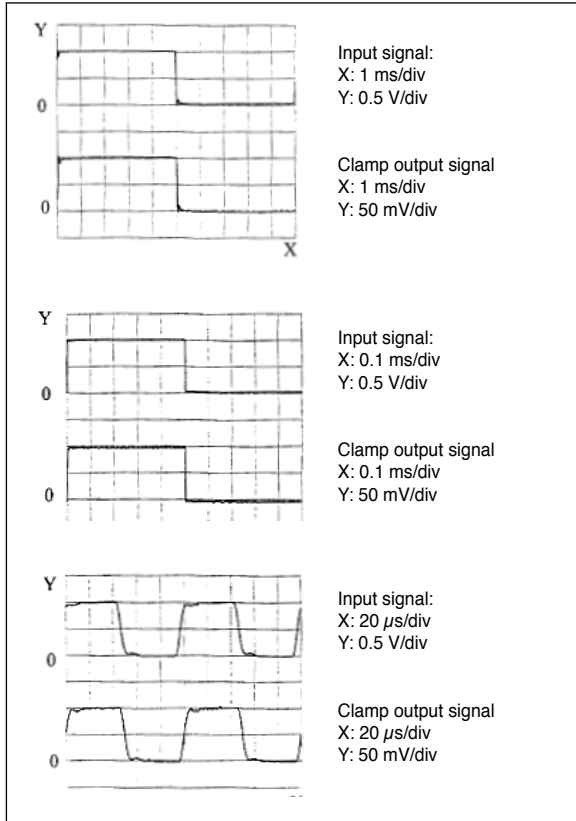

2 A peak

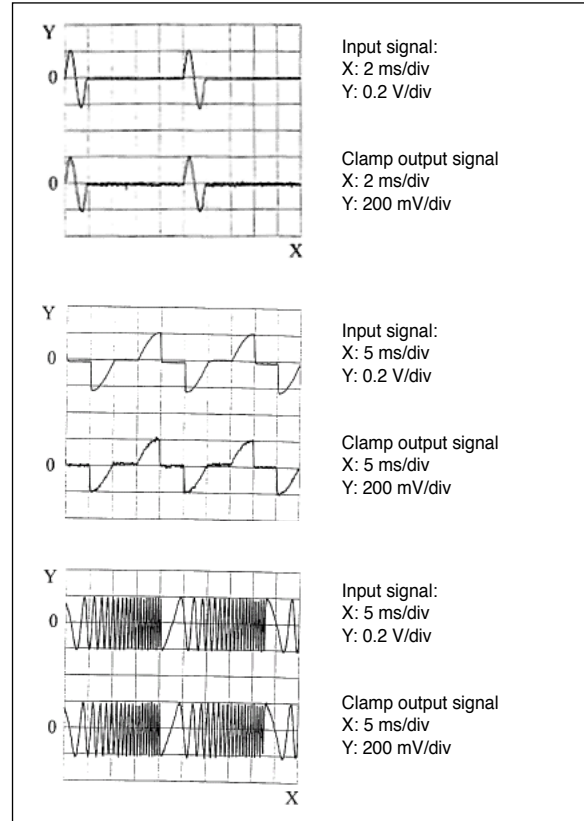

0.1 A peak

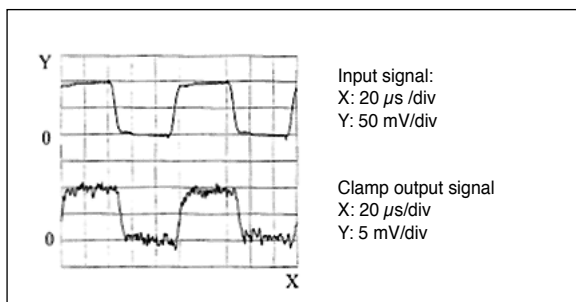

## Model E3N (insulated AC/DC current probe)

### ■ Curves

10 A calibre

10 A peak

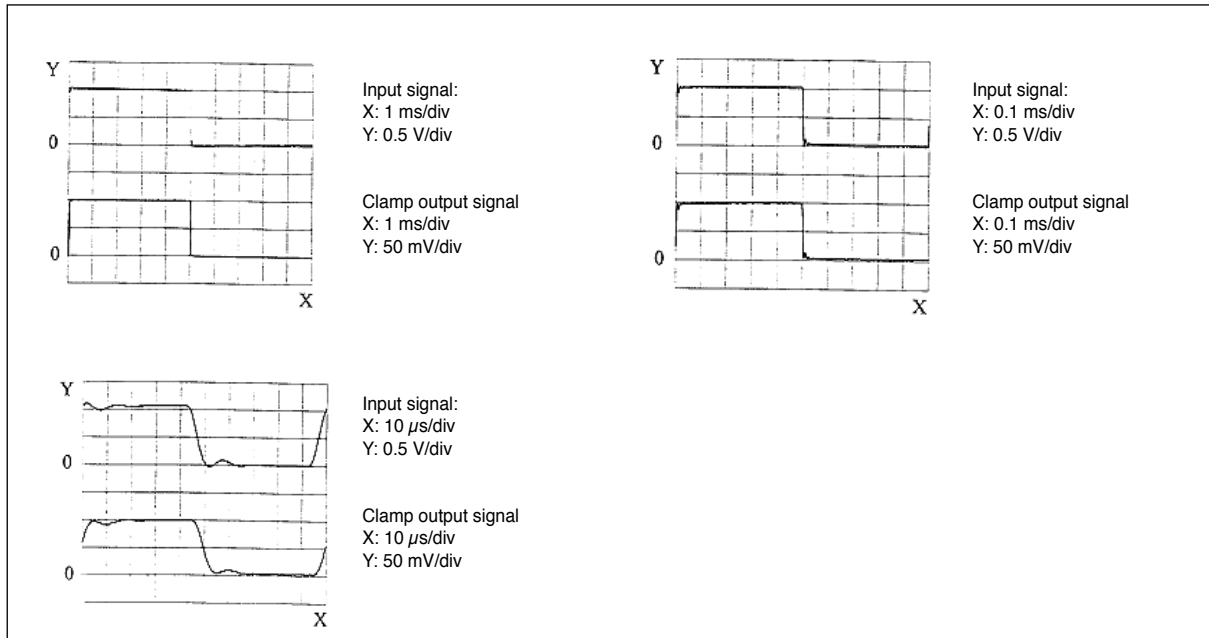

Insertion impedance

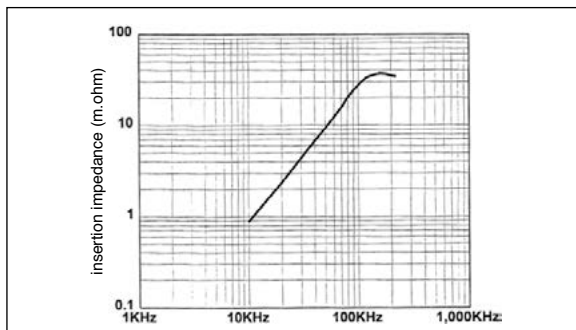

(1) Conditions of reference: 23 °C  $\pm$  5 °K, 20 % to 75 % RH, power supply voltage 8 V  $\pm$  0.1 V DC sinusoidal signal with frequency of DC at 1 kHz, external magnetic field < 40 A/m, no DC components, no external conductor with circulating current, conductor centred for measurement, load impedance >1 M $\Omega$  / < 100 pF.

To order	Reference
Oscilloscope clamp for AC/DC current model <b>E3N</b> , with battery and user's manual	P01120043A
Oscilloscope clamp for AC/DC current model <b>E3N</b> , with mains power pack, battery and user's manual	P01120047



# AC/DC current clamp

## Model E6N

EN series

Calibre	2 A AC/DC	80 A AC/DC
Output	1 mV/mA	10 mV/A

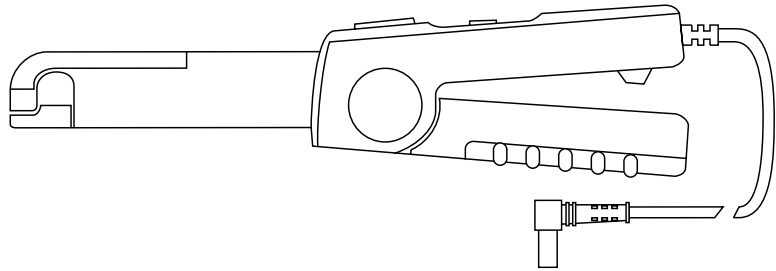

### Electrical specifications

#### Current range:

5 mA...80 A AC/DC over two calibres

#### Output signal:

1 mV/mA and 10 mV/A AC or DC

#### Accuracy and phase shift <sup>(1)</sup>:

Calibre	1 mV/mA (1 V/A)	10 mV/A
Current range	5 mA...2 A DC 5 mA...1.5 A AC	20 mA...80 A DC 20 mA...80 A AC
% Accuracy of output signal	2 % ± 5 mV	20 mA...50 A DC: 4 % ± 200 μV 50 A to 80 A DC: 12 % 20 mA...40 A AC: 4 % ± 200 μV 40 A to 60 A AC: 12 %
Frequency range	DC...2 kHz	DC...8 kHz
Phase shift	DC...65 Hz: 1°	DC...65 Hz: 1°
Min load impedance	> 10 kΩ	> 2 kΩ
Noise	DC...1 Hz: 2 mV 1 Hz...10 kHz: 10 mV 10...100 kHz: 10 mV	DC...1 Hz: 20 μV 1 Hz...10 kHz: 100 μV 10...100 kHz: 100 μV

#### Overload:

120 A continuous

#### Operating voltage:

600 V rms max

#### Common mode voltage:

600 V rms max

#### Battery:

9 V alkaline (NEDA 1604A, IEC 6LR61)

#### Battery life:

70 hours typical

#### Typical consumption:

6 mA

#### Battery level indicator:

Green LED when > 6.5 V

#### Operating altitude:

0 to 2,000 m

#### Max. jaw insertion capacity:

11.8 mm

#### Zero adjustment:

20 turns of potentiometer (± 1.5 A min)

#### Drop test:

1 m on a 38 mm container of oak on concrete, test in accordance with IEC 1010

#### Shock resistance:

100 g, in accordance with IEC 68-2-27

#### Vibration resistance:

10/55/10 Hz, 0.15 mm test in accordance with IEC 68-2-6

#### Casing protection rating:

IP20 in accordance with IEC 529

#### Self-extinguishing capability:

Casing: UL94 V2

#### Dimensions:

231 x 36 x 67 mm

#### Weight:

330 g with batteries

#### Colour:

Dark grey

#### Output:

Via 1.5 m two-wire cable with reinforced or double insulation, terminated by two elbowed 4 mm male safety plugs.

### Safety specifications

#### Electrical safety:

600 V category III, pollution: 2  
300 V category IV, pollution: 2

#### Electromagnetic compatibility (EMC):

EN 50081-1: class B  
EN 50082-2:  
- Electrical discharge IEC 1000-4-2  
- Radial field IEC 1000-4-3  
- Fast transients IEC 1000-4-4  
- Magnetic field at 50/60 Hz IEC 1000-4-8

### Mechanical specifications

#### Operating temperature:

0 °C to +50 °C

#### Storage temperature:

-30 °C to +80 °C

#### Influence of temperature:

< 0.2 % per °C

#### Relative humidity for operation:

+10 °C to +30 °C:

85 ± 5 % RH (without condensation)

+40 °C to +50 °C:

45 ± 5 % RH (without condensation)

(1) Conditions of reference: 23 °C ±5 °K, 20 to 75 % RH, 48 to 65 Hz, external magnetic field < 40 A/m, no current-carrying conductor nearby, centred test sample, load impedance 1 MΩ

To order	Reference
AC/DC current clamp model E6N with battery and user's manual	P01120040A



## PAC series

The PAC series is a range of professional AC/DC current clamps.

There are two different jaw designs available for clamping cables and small busbars.

The PAC series clamps operate on the Hall effect principle, allow current measurement up to 1500 A DC and 1000 A AC. The electronics and the batteries are all located in the clamp handles. There are two sensitivity levels available: 1 mV/A and 10 mV/A.

A push button operates the automatic DC zeroing on models PAC 11, 12, 21 and 22.

Models PAC 10 and PAC 20 have potentiometer-operated zero adjustment.

TRMS measurement with the DC component is possible using a multimeter or power meter with suitable capabilities.

Models PAC 12 and PAC 22 are designed for use with oscilloscopes and other BNC-input instruments.

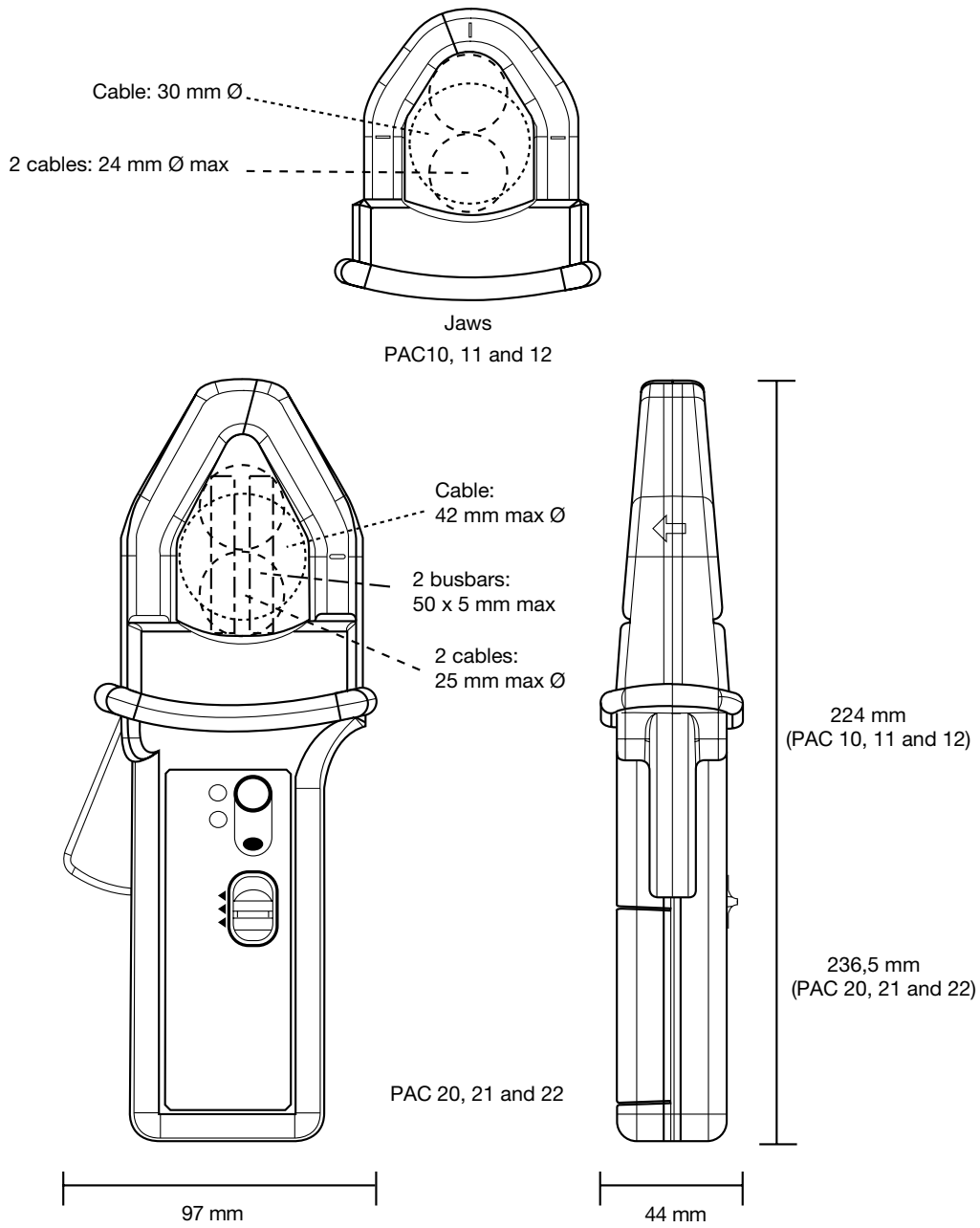

# Current clamp for AC/DC current

## Model PAC10

PAC series

<b>Current</b>	400 A AC 600 A DC
<b>Output</b>	1 mV/A

### Description

Model PAC10 operates using the Hall effect, for precise measurement of AC or DC currents.

It has a mV output so that a direct reading may be made on a multimeter or logging equipment, etc.

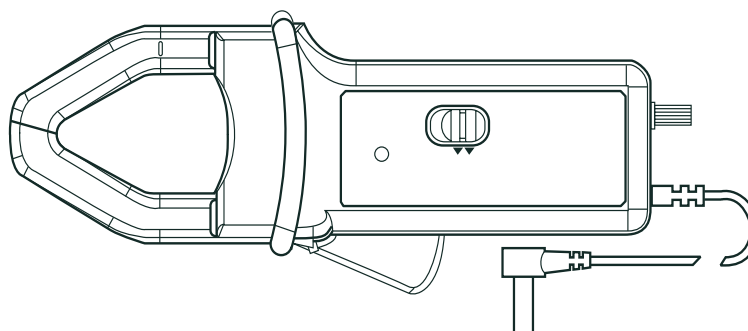

### Electrical specifications

#### Current calibres:

0.5 A AC to 400 A AC (600 A peak)

0.5 A AC to 600 A DC

**Output signal:** 1 mV/A

#### Accuracy <sup>(1)</sup>:

Current range	1 A ... 100 A	100 A ... 400 A
Accuracy in % of output signal	1.5 % ± 1 mV	2 % 400 A ... 600 A DC: 2.5 %

#### Phase shift <sup>(1)</sup>:

Current range	10 A ... 200 A	200 A ... 400 A
Phase shift 45 Hz...65 Hz	< 2.5°	< 2°

#### Overload:

2000 A DC and 1000 A AC up to 1 kHz

#### Bandwidth:

DC...5 kHz

#### Noise:

DC at 1 kHz: < 1 mV

DC at 5 kHz: < 1.5 mV

0.1 Hz at 5 kHz: < 500 µV

#### Load impedance:

1 MΩ and ≤ 100 pF

#### Insertion impedance:

0.39 mΩ at 50 Hz, 58 mΩ at 1000 Hz

#### Rise time and fall time:

< 100 µs from 10 % to 90 % of the voltage value

#### Operating voltage:

600 V rms

#### Common mode voltage:

600 V rms

#### Influence of adjacent conductor:

< 10 mA/A at 50 Hz

#### Influence of conductor position in jaws:

0.5 % of the reading

#### Battery:

9 V alkaline (NEDA 1604 A, IEC 6LR61)

#### Low battery signal:

Green LED when the battery voltage > 6.5 V

#### Battery life:

120 hours with Alkaline battery

### Mechanical specifications

#### Operating temperature:

-10 °C to +55 °C

#### Storage temperature:

-40 °C to +80 °C

#### Relative humidity for operation:

+10 °C to +35 °C: 90 ± 5 % RH (without condensation)

+40 °C to +55 °C: 70 ± 5 % RH (without condensation)

#### Influence of temperature:

< 300 ppm/°K or 0.3 %/10 °K

< 0.3 A/°K

#### Influence of humidity:

10 % to 90 % RH at reference temperature:

< 0.1 %

#### Operating altitude:

0 to 2,000 m

#### DC zero adjustment:

±12 A (10-turn potentiometer)

#### Max. jaw insertion capacity:

1 cable Ø 30 mm or 2 cables Ø 24 mm

#### Casing protection rating:

IP30 in accordance with IEC 529

#### Drop test:

1 m on a 38 mm container of oak on concrete, test in accordance with IEC 1010

#### Shock resistance:

100 g, in accordance with IEC 68-2-27

#### Vibration resistance:

Test in accordance with IEC 68-2-6

#### Frequency range:

5 Hz to 15 Hz: amplitude: 1.5 mm

15 Hz to 25 Hz: amplitude: 1 mm

25 Hz to 55 Hz: amplitude: 0.25 mm

#### Self-extinguishing capability:

Casing and jaws: UL94 V0

#### Dimensions:

224 x 97 x 44 mm

#### Weight:

440 g

#### Colours:

Dark grey and red jaws

#### Output:

via 1.5 m double insulated cable with 4 mm male safety plug

### Safety specifications

#### Electrical safety:

double or reinforced insulation between the primary, the secondary and outer casing in accordance with IEC 1010-1-2 (indoor use).

600 V category III, pollution 2

300 V category IV, pollution 2

#### Electromagnetic compatibility (EMC):

EN 50081-1: class B

EN 50082-2:

- Electrical discharge IEC 1000-4-2

- Radial field IEC 1000-4-3

- Fast transients IEC 1000-4-4

- Magnetic field at 50/60 Hz

IEC 1000-4-8

(1) Conditions of reference: 18 °C at 28 °C, 20 % to 75 % RH, 48 to 65 Hz, external magnetic field < 40 A/m, no DC component, no current-carrying conductor nearby, centred test sample, charge ≥ 1 MΩ and ≤ 100 pF, reset to zero before measurement (only DC) DC to 65 Hz, batteries 9 V ± 0.1 V

To order	Reference
AC/DC current clamp model <b>PAC10</b> with battery and user's manual	P01120070
AC/DC current clamp model <b>PAC10</b> in carrying case with battery and user's manual	P01120070D

## Model PAC11

<b>Current</b>	40 A AC 60 A DC	400 A AC 600 A DC
<b>Output</b>	10 mV/A	1 mV/A

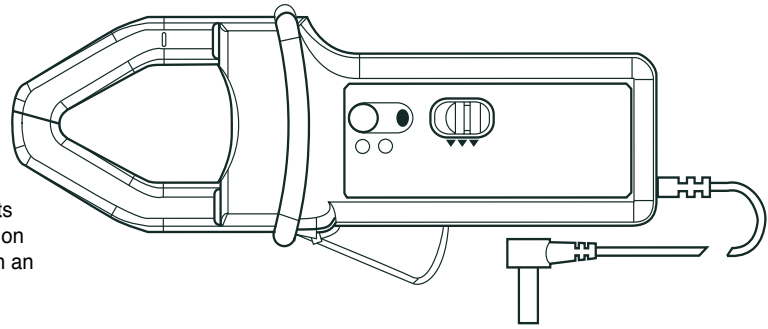

### Description

The PAC11 model accurately measures AC or DC currents using the Hall-effect principle. This clamp with mV output on BNC (direct reading on multimeters, etc.) is equipped with an automatic DC zero system.

### Electrical specifications

Calibre	60 A	600 A
Current range	0.2 A ... 40 A (60 A peak) 0.4 A ... 60 A DC	0.5 A ... 400 A (600 A peak) 0.5 A ... 600 A DC
Output signal	10 mV/A	1 mV/A
% Accuracy of output signal <sup>(1)</sup>	0.5 A...40 A: 1.5 % ±5 mV 40 A...60 A DC: 1.5 %	0.5 A...100 A: 1.5 % ±1 mV 100 A...400 A DC: 2 % 400 A...600 A DC: 2.5 %
Phase shift (45...65 Hz) <sup>(1)</sup>	10 A...20 A: < 3° 20 A...40 A: < 2°	10 A...100 A: < 2° 100 A...400 A: < 1.5°
Noise	DC...1 kHz: < 8 mV DC...5 kHz: < 12 mV 0.1 Hz...5 kHz: < 2 mV	DC...1 kHz: < 1 mV DC...5 kHz: < 1.5 mV 0.1 Hz...5 kHz: < 500 µV
Rise/fall time	≤ 100 µs from 10 % to 90 % of the voltage value	≤ 70 µs from 10 % to 90 % of the voltage value

#### Overload:

2000 A DC and 1000 A AC up to 1 kHz

#### Bandwidth:

DC...10 kHz at -3 dB

#### Load impedance:

≥ 1 MΩ and ≤ 100 pF

#### Insertion impedance:

0.39 mΩ at 50 Hz, 58 mΩ at 1000 Hz

#### Operating voltage:

600 V rms

#### Common mode voltage:

600 V rms

#### Influence of adjacent conductor:

< 10 mA/A at 50 Hz

#### Influence of conductor position in jaws:

0.5 % of the reading

#### Battery:

9 V alkaline (NEDA 1604 A, IEC 6LR61)

#### Low battery signal:

Green LED when the battery voltage > 6.5 V

#### Battery life:

50 hours with Alkaline battery.

#### Overload indicator:

Red LED

Auto switch-off: 0 minute

### Mechanical specifications

#### Operating temperature:

-10 °C to +55 °C

#### Storage temperature:

-40 °C to +80 °C

#### Relative humidity for operation:

+10 °C to +35 °C:

90 ± 5 % RH (without condensation)

+40 °C to +55 °C:

70 ± 5 % RH (without condensation)

#### Influence of temperature:

< 300 ppm/°K or 0.3 %/10 °K

< 0.3 A/°K

#### Influence of humidity:

10 % to 90 % RH at reference temperature:

< 0.1 %

#### Operating altitude:

0 to 2,000 m

#### DC zero adjustment:

Automatically operated by button (± 10 A)

#### Max. jaw insertion capacity:

1 cable Ø 30 mm or 2 cables Ø 24 mm or

2 busbars 31.5 x 10 mm

#### Casing protection rating:

IP30 in accordance with IEC 529

#### Drop test:

1 m on a 38 mm container of oak on concrete, test in accordance with IEC 1010

#### Shock resistance:

100 g, in accordance with IEC 68-2-27

#### Vibration resistance:

Test in accordance with IEC 68-2-6

#### Frequency range:

5 Hz to 15 Hz: amplitude: 1.5 mm

15 Hz to 25 Hz: amplitude: 1 mm

25 Hz to 55 Hz: amplitude: 0.25 mm

#### Self-extinguishing capability:

Casing and jaws: UL94 V0

#### Dimensions:

224 x 97 x 44 mm

#### Weight:

440 g

#### Colours:

Dark grey and red jaws

#### Output:

Via 1.5 m double insulated cable with 4 mm male safety plug

### Safety specifications

#### Electrical safety:

double or reinforced insulation between the

primary, the secondary and outer casing in

accordance with IEC 1010-1-2 (indoor use).

600 V category III, pollution 2

300 V category IV, pollution 2

#### Electromagnetic compatibility (EMC):

EN 50081-1: class B

EN 50082-2:

- Electrical discharge IEC 1000-4-2

- Radial field IEC 1000-4-3

- Fast transients IEC 1000-4-4

- Magnetic field at 50/60 Hz

IEC 1000-4-8

(1) Conditions of reference: 18° at 28°C, 20 to 75 % RH, 48 to 65 Hz, external magnetic field < 40 A/m, no DC component, no current-carrying conductor nearby, centred test sample, charge ≥ 1 MΩ and ≤ 100 pF, reset to zero before measurement (only DC) DC to 65 Hz, batteries 9 V ±0.1 V

To order	Reference
AC/DC current clamp model <b>PAC11</b> with battery and user's manual	P01120068
AC/DC current clamp model <b>PAC11</b> in carrying case with battery and user's manual	P01120068D

## Model PAC12

<b>Current</b>	40 A AC 60 A DC	400 A AC 600 A DC
<b>Output</b>	10 mV/A	1 mV/A

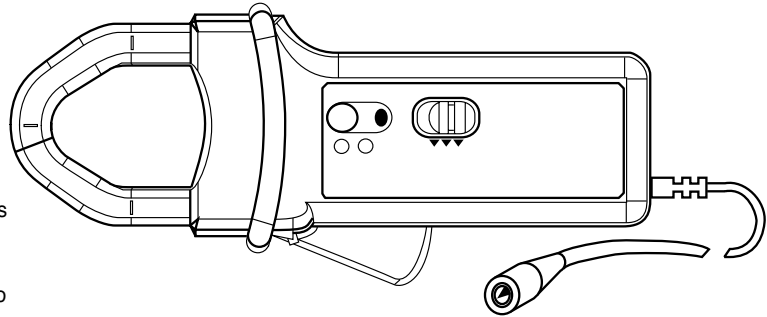

### Description

The PAC12 model accurately measures AC or DC currents by using the Hall-effect principle.

This clamp with mV output on BNC (direct reading on oscilloscopes, etc.) is equipped with an automatic DC Zero system.

### Electrical specifications

#### Current calibres:

0.2 A AC...40 A AC (60 A peak) / 0.4 A DC...60 A DC  
0.5 A AC...400 A AC (600 A peak) / 0.5 A DC...600 A DC

#### Output signal:

10 mV AC+DC / A AC+DC (0.6 V for 60 A)  
1 mV AC+DC / A AC+DC (0.6 V for 600 A)

#### Accuracy and phase shift <sup>(1)</sup>:

##### 60 A calibre

Primary current	0.5 A...10 A	10 A...20 A	20 A...40 A	40 A...60 A (only DC)
Accuracy in % of output signal	≤ 1.5 % + 5 mV	≤ 1.5 % + 5 mV	≤ 1.5 % + 5 mV	≤ 1.5 %
Phase shift	Not specified	≤ 3°	≤ 2.2°	-

##### 600 A calibre

Primary current	0.5 A...10 A	10 A...100 A	100 A...300 A	300 A...400 A	400 A...600 A (only DC)
% Accuracy of output signal	≤ 1.5 % + 1 mV	≤ 1.5 % + 1 mV	≤ 2 %	≤ 2 %	≤ 2.5 %
Phase shift	Not specified	≤ 2.2°	≤ 2.2°	≤ 1.5°	-

#### Bandwidth:

DC...10 kHz (-3 dB) (depending on current value)

#### Rise/fall time from 10 % to 90 %:

29 μs

#### 10 % delay time:

15 μs

#### Insertion impedance (at 400 Hz / 10 kHz):

< 2.7 mΩ / < 72 mΩ

#### Maximum currents:

3000 A DC or 1000 A AC continuous for a frequency ≤ 1 kHz (limitation proportional to the inverse of one third of the frequency above that)

#### DC zero adjustment:

Automatic

##### 60 A calibre:

± 10 A in 25 to 40 mA increments

##### 600 A calibre:

± 10 A in 25 to 40 mA increments

#### Typical output noise level (peak-peak) from DC to 100 kHz:

##### 60 A calibre:

DC to 1 kHz: ≤ 8 mV or 0.8 A DC  
DC to 5 kHz: ≤ 12 mV or 1.2 A DC  
0.1 Hz to 5 kHz: ≤ 2.0 mV rms or 0.2 A rms

##### 600 A calibre:

DC to 1 kHz: ≤ 1 mV or 1 A DC  
DC to 5 kHz: ≤ 1.5 mV or 1.5 A DC  
1 Hz to 5 kHz: ≤ 500 μV rms or 0.5 A rms

#### Battery:

9 V alkaline (NEDA 1604A, IEC 6LR61)

#### Battery life:

50 hours typical

#### Typical consumption:

10 mA typical / 14 mA max.

#### Battery level indicator:

Green LED

#### Overload indicator:

Red LED indicates if measured current is too high for the selected range

Influence of power supply voltage:  
≤ 0.1 % of the reading

#### Influence of temperature:

Measurement: ≤ 300 ppm/K or 0.3 % of output signal per 10 °K  
DC zero: 40 mA/10 °K

#### Influence of relative humidity:

< 0.5 % of output signal

#### Influence of adjacent conductor at 23 mm:

≤ 10 mA/A at 50 Hz

#### Influence of external field:

≤ 1.3 A pour 400 A/m

#### Influence of Ø 20 mm conductor position in jaws:

DC at 440 Hz: ≤ 0.5 % of the reading

DC at 1 kHz: ≤ 1 % of the reading

DC at 2 kHz: ≤ 3 % of the reading

DC at 5 kHz: ≤ 10 % of the reading

#### Influence of frequency <sup>(2)</sup>:

< 1 % of output signal from 65 Hz...440 Hz

< 3.5 % of output signal from 440 Hz...2 kHz

3 dB % of output signal from 2 kHz...10 kHz

#### Common mode rejection:

> 65 dB A/V at 50 Hz

#### Remanence:

0 to 50 A DC: 0.8 A typical

0 to 100 A DC: 1.3 A typical

0 to 200 A DC: 2.1 A typical

0 to 400 A DC: 3.3 A typical

0 to 600 A DC: 4.0 A typical

# Oscilloscope clamp for AC/DC current

## Model PAC12

PAC series

### ■ Mechanical specifications

**Max. jaw opening:**  
31 mm

**Clamping capacity:**

Cables: Ø 30 mm  
          Ø 24 mm x 2  
Bars: 1 busbar 50 x 10 mm  
      2 busbars 31.5 x 10 mm  
      3 busbars 25 x 8 mm  
      4 busbars 25 x 5 mm

**Output:**

Coaxial cable 2 m long, terminated by an insulated BNC connector

**Dimensions:**

224 x 97 x 44 mm

**Weight:**

440 g with battery

**Operating temperature:**

-10 °C to +55 °C

**Storage temperature:**

-40 °C to +80 °C

**Relative humidity for operation:**

0 to 85 % RH with a linear decrease above 35 °C

**Operating altitude:**

0 to 2,000 m

**Casing protection rating:**

IP40 (IEC 529)

**Drop test:**

1 m (IEC 68-2-32)

**Shock resistance:**

100 g / 6 ms / half-period (IEC 68-2-27)

**Protection against impacts:**

IK04 0.5 J (EN 50102)

**Vibration resistance:**

5-15 Hz: 1.5 mm peak  
15-25 Hz: 1 mm peak  
25-55 Hz: 0.25 mm peak  
(IEC 68-2-6)

**Self-extinguishing capability:**

UL94 V2

**Colours:**

Dark grey casing with red jaws

### ■ Safety specifications

**Electrical safety:**

Instrument with double insulation or reinforced insulation between the primary, the secondary and the grippable part located under the guard as per IEC 1010-1 & IEC 1010-2-032

- 600 V category III, pollution degree 2

- 300 V category IV, pollution degree 2

**Electromagnetic compatibility (EMC):**

EN 50081-1: class B

EN 50082-2:

- Electrostatic discharge IEC 1000-4-2:

4 kV in contact, performance criterion B

8 kV in the air, performance criterion B

- Radiated field IEC 1000-4-3:

3 V/m level 2: influence < 5 % of measurement range

- Fast transients IEC 1000-4-4:

1 kV performance criterion B

- Magnetic field at the network frequency

IEC 1000-4-8:

field of 30 A/m at 50 Hz level 4

performance criterion A

- Conducted disturbances (IEC 1000-4-6):

3 V performance criterion A

(1) Conditions of reference: 23 °C ± 5 °K, 20 % at 75 % RH, power supply voltage 9 V ± 0.1 V DC sinusoidal signal with frequency of DC to 65 Hz, external magnetic field < 40 A/m, no DC components, no external conductor with circulating current, conductor centred for measurement, load impedance > 1 MΩ / < 100 pF.

(2) Out of reference domain.

To order	Reference
AC/DC current clamp model <b>PAC12</b> for oscilloscope with battery and user's manual	P01120072

# Oscilloscope clamp for AC/DC current

## Model PAC12

PAC series

### Curves

60 A calibre

600 A calibre

Linearity with DC

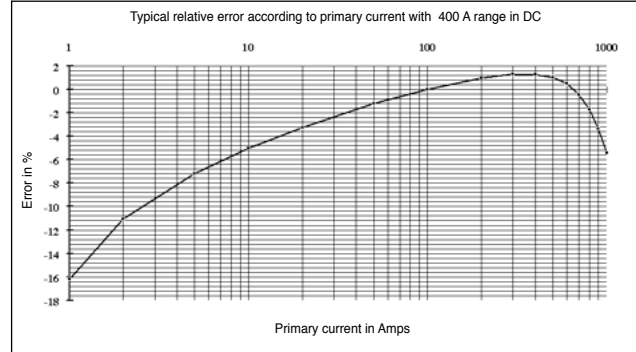
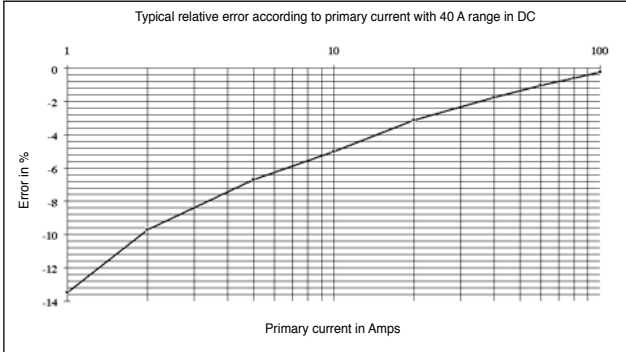

Linearity for AC

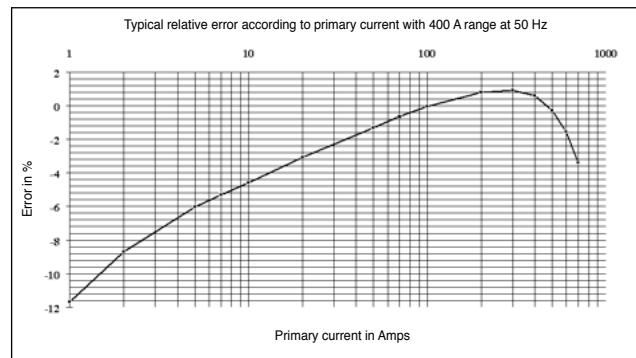
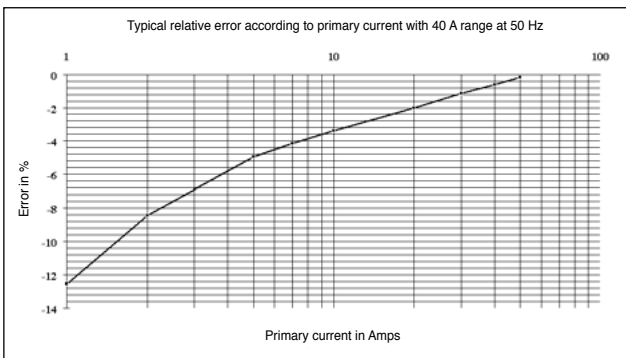

Phase shift

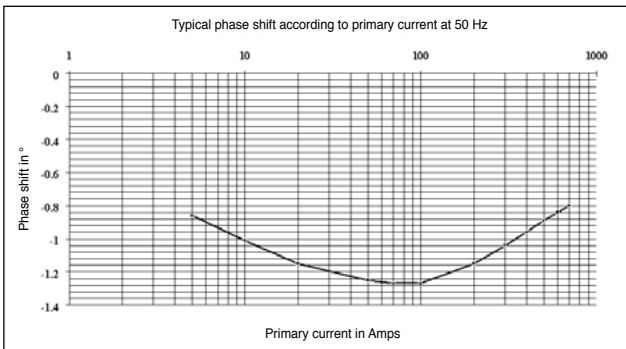

Limitation of measurable current according to the frequency

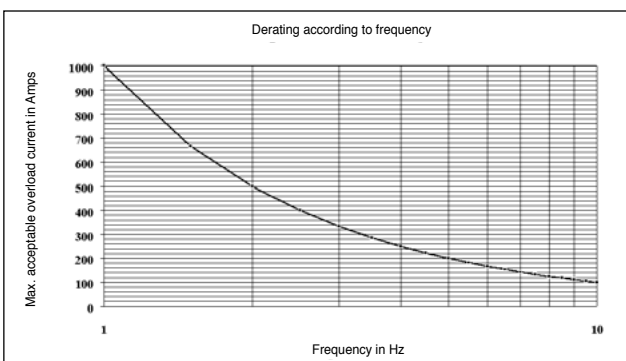



# Oscilloscope clamp for AC/DC current

## Model PAC12

PAC series

### Curves

600 A calibre

Frequency response

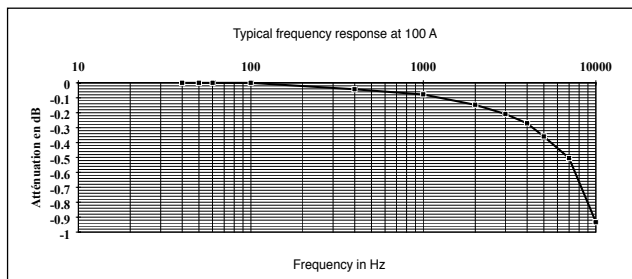

Attenuation according to the frequency

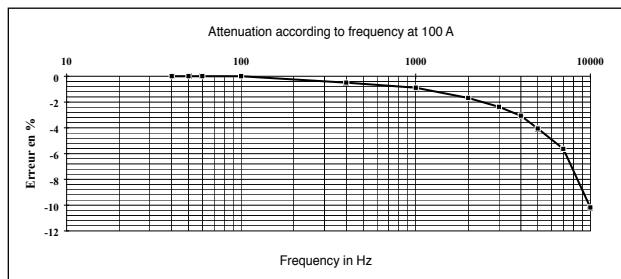

60 A calibre

600 A calibre

Pulse response

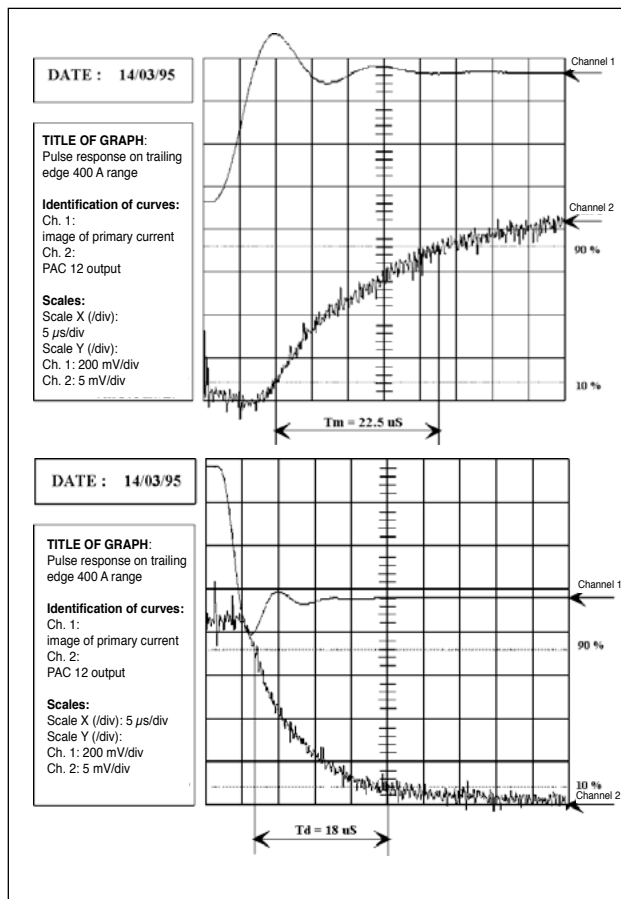
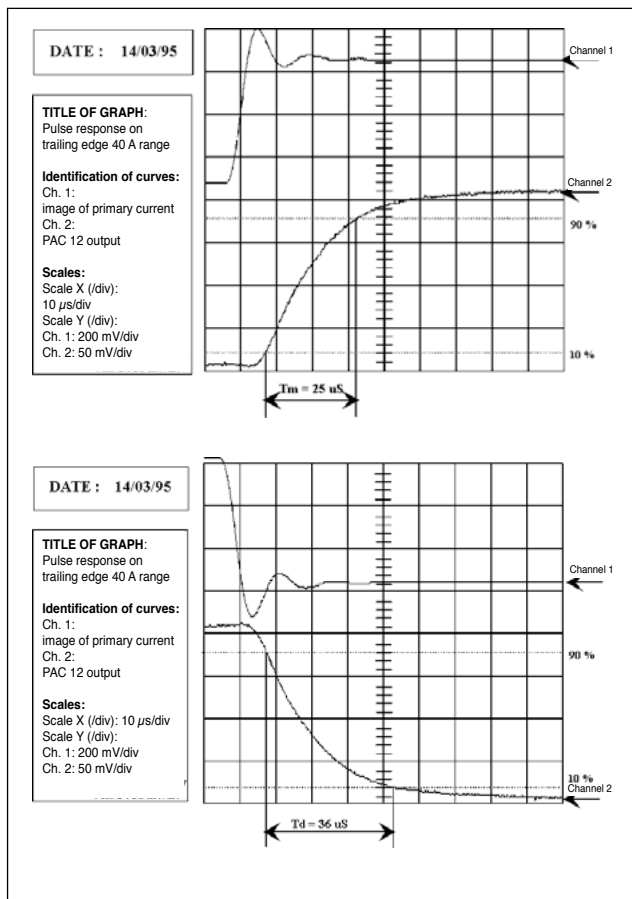

## Model PAC20

<b>Current</b>	1000 A AC 1400 A DC
<b>Output</b>	1 mV/A

### Description

The PAC20 model accurately measures AC or DC currents by using the Hall-effect principle.

This clamp has a mV output so that direct readings may be made with a multimeter or logging equipment, etc.

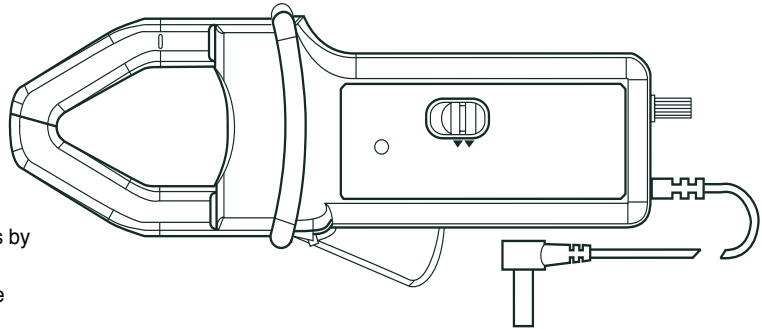

### Electrical specifications

#### Current calibres:

0.5 A...1000 A AC (1400 A peak)

0.5 A...1400 A DC

#### Output signal:

1 mV/A

#### Accuracy <sup>(1)</sup>:

Current range	1 A ... 100 A	100 A ... 800 A	800 A ... 1000 A
Accuracy in % of output signal	1.5 % ± 1 mV	2.5 %	4 % 1000 A ... 1400 A DC: 4 %

#### Phase shift <sup>(1)</sup>:

Current range	10 A ... 200 A	200 A ... 1000 A
Phase shift 45 Hz...65 Hz	< 2.5°	< 2°

#### Overload:

3000 A DC and 2000 A AC up to 1 kHz

#### Bandwidth:

DC...5 kHz

#### Noise:

DC...1 kHz: < 1 mV

DC...5 kHz: < 1.5 mV

0.1 Hz...5 kHz: < 500 µV

#### Load impedance:

> 100 kΩ at 100 pF

#### Insertion impedance:

0.39 mΩ at 50 Hz, 58 mΩ at 1000 Hz

#### Rise/fall time:

##### Rise:

< 100 µs from 10 % to 90 % of the voltage value

##### Fall:

< 100 µs from 10 % to 90 % of the voltage value

#### Operating voltage:

600 V rms

#### Common mode voltage:

600 V rms

#### Influence of adjacent conductor:

< 10 mA/A at 50 Hz

#### Influence of conductor position in jaws:

0.5 % of the reading

#### Battery:

9 V alkaline (NEDA 1604 A, IEC 6LR61)

#### Low battery signal:

Green LED when the battery voltage > 6.5 V

#### Battery life:

120 hours with Alkaline battery

### Mechanical specifications

#### Operating temperature:

-10 °C to +55 °C

#### Storage temperature:

-40 °C to +80 °C

#### Relative humidity for operation:

+10 °C to +35 °C: 90 ± 5 % RH (without condensation)

+40 °C to +55 °C: 70 ± 5 % RH (without condensation)

#### Influence of temperature:

< 300 ppm/°K or 0.3 %/10 °K  
< 0.3 A/°K

#### Influence of humidity:

10 %...90 % RH at reference temperature:  
< 0.1 %

#### Operating altitude:

0 to 2,000 m

#### Zero adjustment:

±12 A (10-turn potentiometer)

#### Max. jaw insertion capacity:

1 cable Ø 42 mm, 2 cables Ø 25.4 mm or 2 busbars 50 x 5 mm

#### Casing protection rating:

IP30 in accordance with IEC 529

#### Drop test:

1 m on a 38 mm container of oak on concrete, test in accordance with IEC 1010

#### Shock resistance:

100 g, in accordance with IEC 68-2-27

#### Vibration resistance:

Test in accordance with IEC 68-2-6

#### Frequency range:

5 to 15 Hz: amplitude: 1.5 mm

15 to 25 Hz: amplitude: 1 mm

25 to 55 Hz: amplitude: 0.25 mm

#### Self-extinguishing capability:

Casing and jaws: UL 94 V0

#### Dimensions:

236.5 x 97 x 44 mm

#### Weight:

520 g

#### Colours:

Dark grey and red jaws

#### Output:

via 1.5 m double insulated cable with 4 mm male safety plug

### Safety specifications

#### Electrical safety:

double or reinforced insulation between the primary the secondary and outer casing in accordance with IEC 1010-1-2 (indoor use).

600 V category III, pollution 2

300 V category IV, pollution 2

#### Electromagnetic compatibility (EMC):

EN 50081-1: class B

EN 50082-2:

- Electrical discharge IEC 1000-4-2

- Radial field IEC 1000-4-3

- Fast transients IEC 1000-4-4

- Magnetic field at 50/60 Hz

IEC 1000-4-8

(1) Conditions of reference: 18 °C at 28 °C, 20 % to 75 % RH, 48 Hz to 65 Hz, external magnetic field < 40 A/m, no DC component, no current-carrying conductor nearby, centred test sample, charge ≥ 1 MΩ and ≤ 100 pF, reset to zero before measurement (only DC) DC to 65 Hz, battery 9 V ±0.1 V

To order	Reference
AC/DC current clamp model PAC20 with battery and user's manual	P01120071
AC/DC current clamp model PAC20 in carrying case with battery and user's manual	P01120071D

## Model PAC21

<b>Current</b>	100 A AC 150 A DC	1000 A AC 1400 A DC
<b>Output</b>	10 mV/A	1 mV/A

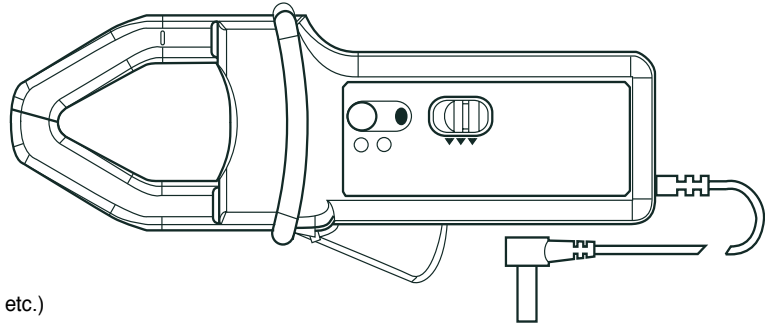

### Description

The PAC21 model accurately measures AC or DC currents using the Hall-effect principle.

This clamp with mV output (direct reading on multimeters, etc.) is equipped with an automatic DC zero system.

### Electrical specifications

Calibre	150 A	1400 A
Current range	0.2 A ... 100 A (150 A peak) 0.4 A ... 150 A DC	0.5 A ... 1000 A (1400 A peak) 0.5 A ... 1400 A DC
Output signal	10 mV/A	1 mV/A
% Accuracy of output signal <sup>(1)</sup>	0.5 A...20 A: 1.5 % ±5 mV 20 A...100 A DC: 1.5 % 100 A...150 A DC: 2.5 %	0.5 A...100 A: 1.5 % ±1 mV 100 A...800 A DC: 2.5 % 800 A...1000 A DC: 4 % 1000 A...1400 A DC: 4 %
Phase shift (45...65 Hz) <sup>(1)</sup>	10 A...20 A: < 3° 20 A...100 A: < 2°	10 A...200 A: < 2° 200 A...1000 A: < 1.5°
Noise	DC...1 kHz: < 8 mV DC...5 kHz: < 12 mV 0.1 Hz...5 kHz: < 2 mV	DC...1 kHz: < 1 mV DC...5 kHz: < 1.5 mV 0.1 Hz...5 kHz: < 500 µV
Rise/fall time	≤ 100 µs from 10 % to 90 % of the voltage value	≤ 70 µs from 10 % to 90 % of the voltage value

#### Drop test:

1 m on a 38 mm container of oak on concrete, test in accordance with IEC 1010

#### Shock resistance:

100 g, in accordance with IEC 68-2-27

#### Vibration resistance:

test in accordance with IEC 68-2-6

#### Frequency range:

5 to 15 Hz: amplitude: 1.5 mm  
15 to 25 Hz: amplitude: 1 mm  
25 to 55 Hz: amplitude: 0.25 mm

#### Self-extinguishing capability:

Casing and jaws: UL94 V0

#### Dimensions:

236.5 x 97 x 44 mm

#### Weight:

520 g

#### Colours:

Dark grey and red jaws

#### Output:

Via 1.5 m double insulated cable with 4 mm male safety plug

### Safety specifications

#### Electrical safety:

double or reinforced insulation between the primary, the secondary and outer casing in accordance with IEC 1010-1-2 (indoor use).  
600 V category III, pollution 2  
300 V category IV, pollution 2

#### Electromagnetic compatibility (EMC):

EN 50081-1: class B  
EN 50082-2:  
- Electrical discharge IEC 1000-4-2  
- Radial field IEC 1000-4-3  
- Fast transients IEC 1000-4-4  
- Magnetic field at 50/60 Hz IEC 1000-4-8

### Mechanical specifications

#### Operating temperature:

-10 °C to +55 °C

#### Storage temperature:

-40 °C to +80 °C

#### Relative humidity for operation:

+10 °C to +35°C: 90 ± 5 % RH (without condensation)  
+40 °C to +55 °C: 70 ± 5 % RH (without condensation)

#### Influence of temperature:

< 300 ppm/°K or 0.3 %/10 °K  
< 0.3 A/°K

#### Influence of humidity:

10 % to 90 % RH at reference temperature:  
< 0.1 %

#### Operating altitude:

0 to 2,000 m

#### Zero adjustment:

± 10 A by pushbutton

#### Max. jaw insertion capacity:

1 cable Ø 42 mm, 2 cables Ø 25.4 mm or  
2 busbars 50 x 5 mm

#### Casing protection rating:

IP30 in accordance with IEC 529

#### Overload:

3000 A DC and 2000 A AC up to 1 kHz

#### Bandwidth:

DC...10 kHz at -3 dB

#### Load impedance:

≥ 1 MΩ and ≤ 100 pF

#### Insertion impedance:

0.39 mΩ at 50 Hz, 58 mΩ at 1000 Hz

#### Operating voltage:

600 V rms

#### Common mode voltage:

600 V rms

#### Influence of adjacent conductor:

< 10 mA/A at 50 Hz

#### Influence of conductor position in jaws:

0.5 % of the reading

#### Battery:

9 V alkaline (NEDA 1604 A, IEC 6LR61)

#### Low battery signal:

Green LED when the battery voltage > 6.5 V

#### Battery life:

50 hours Alkaline battery

#### Overload indicator:

red LED

#### Auto switch-off:

10 minutes

(1) Conditions of reference: 18 °C at 28 °C, 20 % to 75 % RH, 48 Hz to 65 Hz, external magnetic field < 40 A/m, no DC component, no current-carrying conductor nearby, centred test sample, charge ≥ 1 MΩ and ≤ 100 pF, reset to zero before measurement (only DC) DC to 65 Hz, battery 9 V ±0.1 V

To order	Reference
AC/DC current clamp model PAC21 with battery and user's manual	P01120069
AC/DC current clamp model PAC21 in carrying case with battery and user's manual	P01120069D

## Model PAC22 (insulated current probe)

<b>Current</b>	100 A AC 150 A DC	1000 A AC 1400 A DC
<b>Output</b>	10 mV/A	1 mV/A

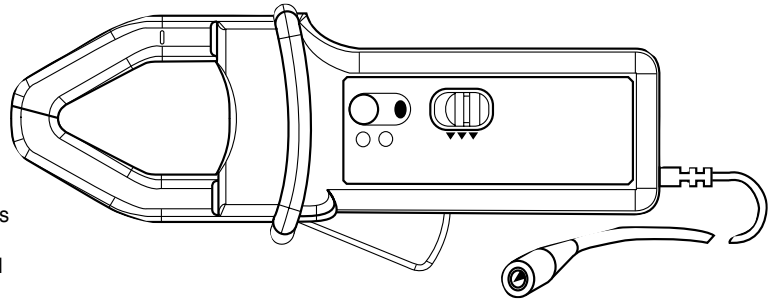

### Description

The PAC22 model accurately measures AC or DC currents using the Hall-effect principle. This clamp with mV output on BNC (direct reading on oscilloscopes, etc.) is equipped with an automatic DC zero system.

### Electrical specifications

#### Current calibres:

0.2 A AC...100 A AC (150 A peak) / 0.4 A DC...150 A DC  
0.5 A AC...1000 A AC (1400 A peak) / 0.5 A DC...1400 A DC

#### Output signal:

10 mV AC+DC / A AC+DC (1.5 V for 150 A)  
1 mV AC+DC / A AC+DC (1.4 V for 1400 A)

#### Accuracy and phase shift <sup>(1)</sup>:

##### 150 A calibre

Primary current	0.5 A...10 A	10 A...20 A	20 A...100 A	100 A...150 A (only DC)
Accuracy in % of output signal	≤ 1.5 % + 5 mV	≤ 1.5 % + 5 mV	≤ 1.5 %	≤ 1.5 %
Phase shift	Not specified	≤ 3°	≤ 2.2°	-

##### 1400 A calibre

Primary current	0.5 A...10 A	10 A...100 A	100 A...200 A	200 A...800 A	800 A...1000 A	1000 A...1400 A (only DC)
Accuracy in % of output signal	≤ 1.5 % + 1 mV	≤ 1.5 % + 1 mV	≤ 2.5 %	≤ 2.5 %	≤ 4 %	≤ 4 %
Phase shift	Not specified	≤ 2°	≤ 2°	≤ 1.5°	≤ 1.5°	-

#### Bandwidth:

DC...10 kHz (-3 dB) (depending on current value)

#### Rise/fall time from 10 % to 90 %:

24 μs

#### 10 % delay time:

15 μs

#### Insertion impedance (at 400 Hz / 10 kHz)

< 2.7 mΩ / < 67 mΩ

#### Maximum currents:

3000 A DC or 1000 A AC continuous for a frequency ≤ 1 kHz (limitation proportional to the inverse of one third of the frequency above that)

#### DC zero adjustment:

Automatic

##### 60 A calibre:

± 10 A in 25 mA to 40 mA increments

##### 600 A calibre:

± 10 A in 25 mA to 40 mA increments

#### Typical output noise level (peak-peak) from DC to 100 kHz:

##### 150 A calibre:

DC to 1 kHz: ≤ 8 mV or 0.8 A DC

DC to 5 kHz: ≤ 12 mV or 1.2 A DC

0.1 Hz to 5 kHz: ≤ 2.0 mV rms or 0.2 Arms

##### 1400 A calibre:

DC to 1 kHz: ≤ 1 mV or 1 A DC

DC to 5 kHz: ≤ 1.5 mV or 1.5 A DC

1 Hz to 5 kHz: ≤ 500 μV rms or 0.5 A rms

#### Output impedance:

100 Ω

#### Battery:

9 V alkaline (NEDA 1604A, IEC 6LR61)

#### Battery life: 50 hours typical

#### Typical consumption:

10 mA typical / 14 mA max.

#### Battery level indicator:

Green LED

#### Overload indicator:

Red LED indicates the measured current is too high for the selected range

Influence of power supply voltage:

≤ 0.1 % of the reading

#### Influence of temperature:

Measurement: ≤ 300 ppm/K or 0.3 % of output signal per 10 °K

DC zero: 40 mA/10 °K

#### Influence of relative humidity:

< 0.5 % of output signal

#### Influence of adjacent conductor at 23 mm:

≤ 10 mA/A at 50 Hz

#### Influence of external field:

≤ 1.3 A for 400 A/m

#### Influence of Ø 20 mm conductor position in jaws:

DC to 440 Hz: ≤ 0.5 % of the reading

DC to 1 kHz: ≤ 1 % of the reading

DC to 2 kHz: ≤ 3 % of the reading

DC to 5 kHz: ≤ 10 % of the reading

#### Influence of frequency <sup>(2)</sup>:

< 1 % of output signal from 65 Hz to 440 Hz

< 3.5 % of output signal from 440 Hz to 2 kHz

3 dB % of output signal from 2 kHz to 10 kHz

#### Common mode rejection:

> 65 dB A/V at 50 Hz

#### Remanence:

0 to 100 A DC: 1 A typical

0 to 250 A DC: 1.7 A typical

0 to 500 A DC: 2.5 A typical

0 to 1000 A DC: 3.6 A typical

0 to 1400 A DC: 4.4 A typical

## Model PAC22 (insulated current probe)

### ■ Mechanical specifications

**Max. jaw opening:**  
31 mm

**Clamping capacity:**

Cables: Ø 25.4 mm x 2  
Bars: 1 busbar 50 x 12.5 mm  
2 busbars 50 x 5 or 31.5 x 10 mm  
3 busbars 25 x 8 mm  
4 busbars 25 x 5 mm

**Output:**

Coaxial cable 2 m long, terminated by an insulated BNC connector

**Dimensions:**

236.5 x 97 x 44 mm

**Weight:**

520 g with battery

**Operating temperature:**

-10 °C to +55 °C

**Storage temperature:**

-40 °C to +80 °C

**Relative humidity for operation:**

0 to 85 % RH with a linear decrease above 35 °C

**Operating altitude:**

0 to 2,000 m

**Casing protection rating:**

IP40 (IEC 529)

**Drop test:**

1 m (IEC 68-2-32)

**Shock resistance:**

100 g / 6 ms / half-period (IEC 68-2-27)

**Protection against impacts:**

IK04 0.5 J (EN 50102)

**Vibration resistance:**

5-15 Hz: 1.5 mm peak  
15-25 Hz: 1 mm peak  
25-55 Hz: 0.25 mm peak  
(IEC 68-2-6)

**Self-extinguishing capability:**

UL94 V2

**Colours:**

Dark grey casing with red jaws

### ■ Safety specifications

**Electrical safety:**

Instrument with double insulation or reinforced insulation between the primary, the secondary and the grippable part located under the guard as per IEC 1010-1 & IEC 1010-2-032

- 600 V category III, pollution degree 2
- 300 V category IV, pollution degree 2

**Electromagnetic compatibility (EMC):**

EN 50081-1: class B

EN 50082-2:

- Electrostatic discharge IEC 1000-4-2:
  - 4 kV in contact, performance criterion B
  - 8 kV in the air, performance criterion B
- Radiated field IEC 1000-4-3:
  - 3 V/m level 2: influence < 5 % of measurement range
- Fast transients IEC 1000-4-4:
  - 1 kV performance criterion B
- Magnetic field at the network frequency (IEC 1000-4-8):
  - field of 30 A/m at 50 Hz level 4 performance criterion A
- Conducted disturbances (IEC 1000-4-6):
  - 3 V performance criterion A

(1) Conditions of reference: 23 °C ± 5 °K, 20 % at 75 % RH, power supply voltage 9 V ± 0.1 V DC sinusoidal signal with frequency of DC to 65 Hz, external magnetic field < 40 A/m, no DC components, no external conductor with circulating current, conductor centred for measurement, load impedance > 1 MΩ / < 100 pF.

(2) Out of reference domain.

To order	Reference
Current clamp for AC/DC current model PAC22 for oscilloscope with battery and user's manual	P01120073

# Current clamp for AC/DC current

## Model PAC22 (insulated current probe)

PAC series

### Curves

150 A calibre

1400 A calibre

Linearity in DC

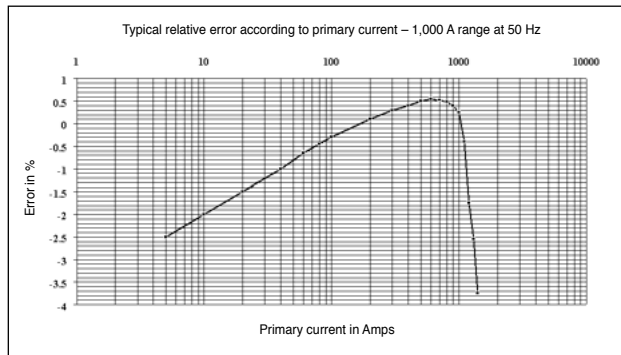
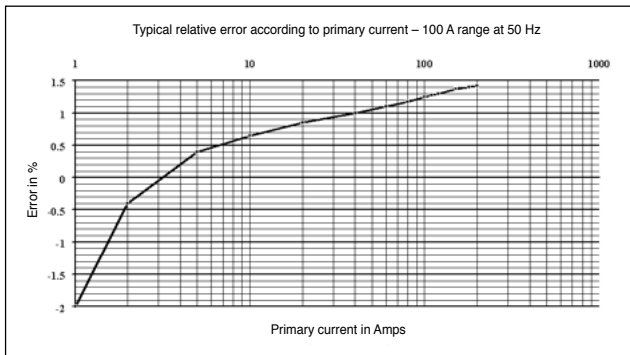

Linearity in AC

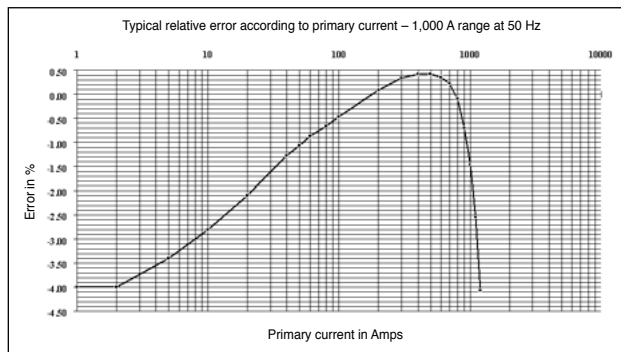
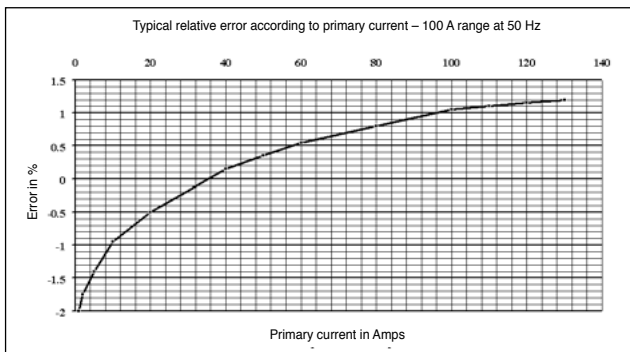

Phase shift

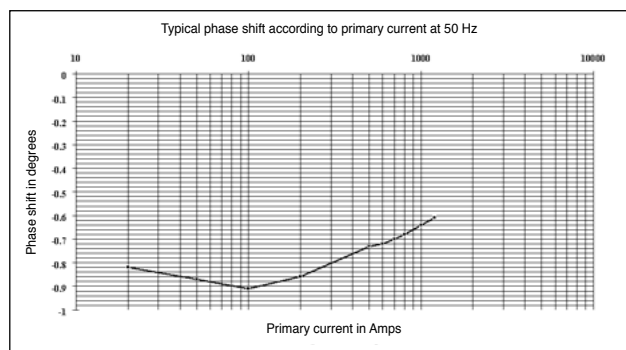

Limitation of measurable current according to the frequency

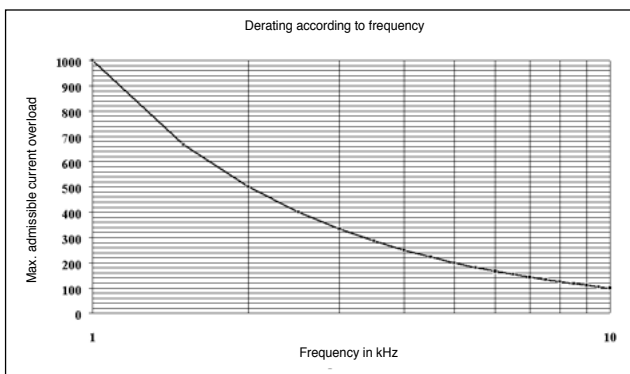

## Model PAC22 (insulated current probe)

### Curves

Frequency response

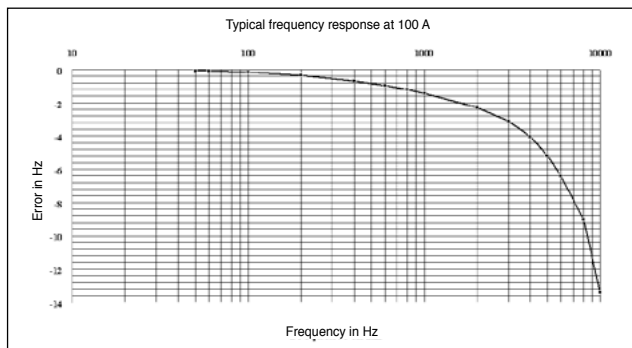

150 A calibre

Attenuation according to frequency

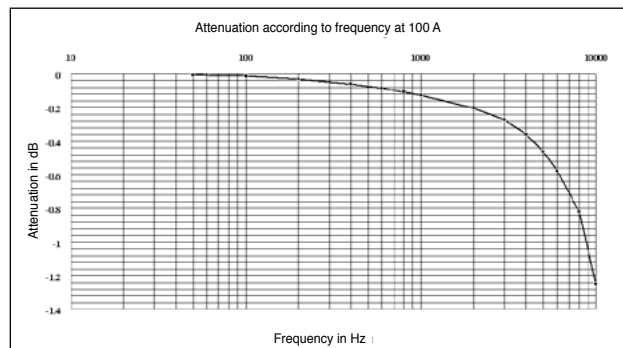

1400 A calibre

Pulse response

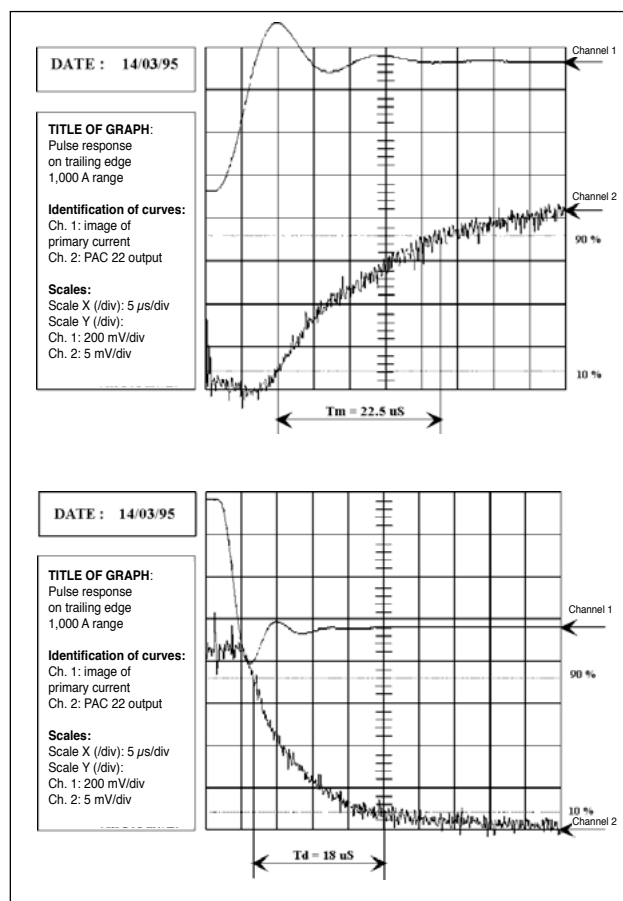
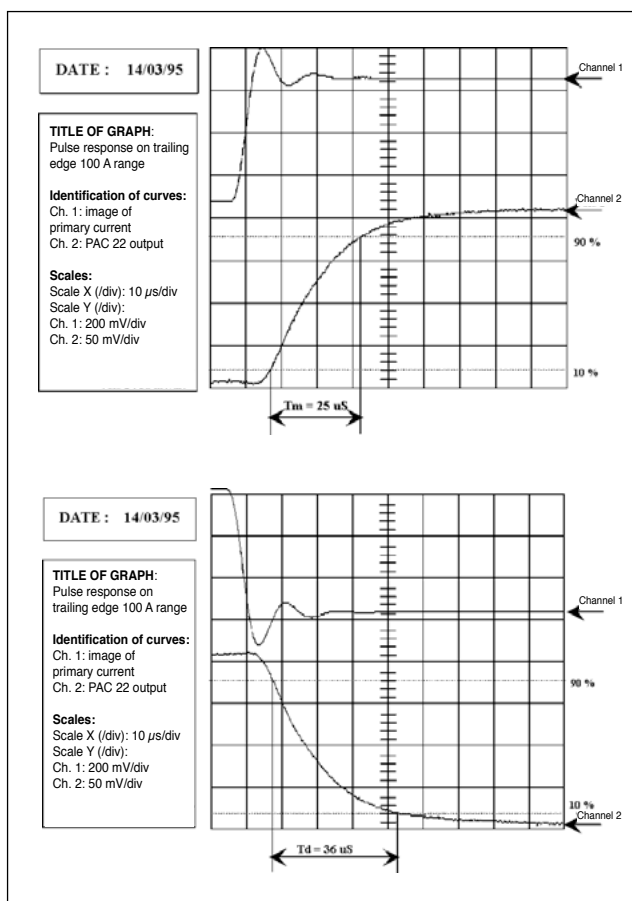

# Accessories



## Clamp accessories

Having made test, control and measurement instruments for over a century now, Chauvin Arnoux products are the result of years of experience in the field. A knowledge of measurement techniques and daily experience in safety practices has led to the development of an entire range of practical and safety-conscious test accessories. Throughout the range, from the artificial neutral to the BNC/ female safety socket, or silicone leads with banana plugs (straight or elbowed), the IEC 61010 standard is the benchmark by which all products are judged.

However, even a device that complies with this standard does not guarantee complete safety, so make sure that you are equipped with suitable accessories with which you can verify that your equipment meets the most demanding safety standards.



## Mains adapters

For unlimited operation of your current clamps, replace the battery with the mains adapter.

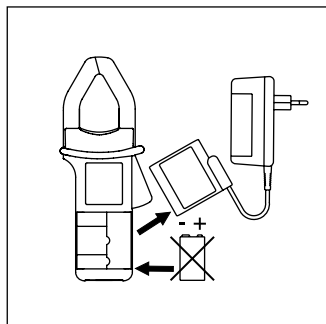

For PAC clamp

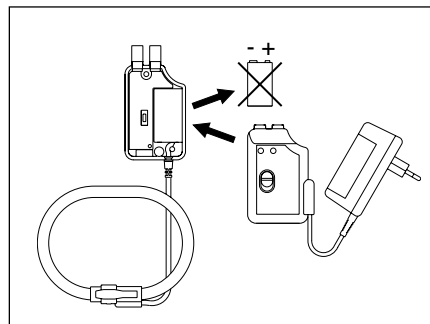

For AmpFLEX™ and MiniFLEX clamps and K clamps

To order	Reference
Mains adapter for E clamp	P01101965
Mains adapter for K clamp	P01101966
Mains adapter for PAC clamp	P01101967
Mains adapter for AmpFLEX A100	P01101968
Mains adapter for MA 100 clamp	P01102086
Mains adapter for MA200 clamp	P01102087

## Leads and adapters



### Standard PVC leads

Straight male plug Ø 4 mm  
Elbowed male plug Ø 4 mm  
15 A / 1.5 m  
600 V CAT IV  
1,000 V CAT III



### BNC / banana adapter

Insulated female socket  
Insulated male plugs  
Ø 4 mm with 19 mm spacing  
600 V CAT III



### Banana-BNC leads

Insulated BNC  
Male plug Ø 4 mm  
with rear connection  
500 V CAT III



### BNC / banana adapter

Male BNC  
Female sockets  
500 V CAT I  
150 V CAT III



### BNC / banana adapter

Male BNC  
Male plugs  
500 V CAT I  
150 V CAT III

To order	Reference
Standard PVC leads (1 red + 1 black)	P01295289Z
Banana-BNC leads	AG-1066Z
Male BNC / Female banana adapter (set of 2)	P01101846
Male BNC / Male banana adapter (set of 2)	P01101847
Female BNC / Isolated banana adapter (set of 2)	P01102101Z

# Artificial neutral box

## Model AN1

### Description

This instrument is designed for use with MN73, C173 and B102 leakage-current detection clamps to enable fault current measurements on 3-phase circuits without a neutral conductor.

There is a switch for selecting the test rate so that the MN73, C173 and B clamps can be used with digital or analogue multimeters.

A built-in buzzer indicates when the artificial neutral is connected to the earth. Three LEDs indicate when a voltage is present on each of the 3 phases and during measurement.

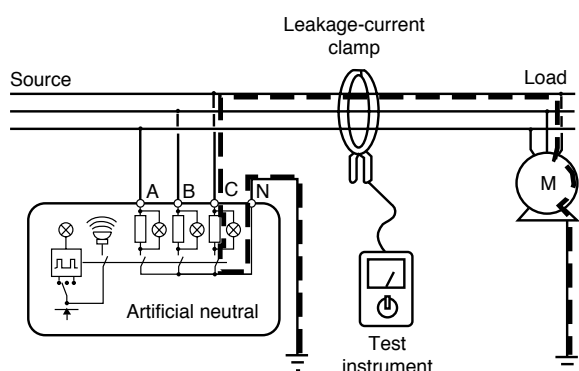

### Electrical specifications

**Operating voltage:**  
30 V at 600 V

**Frequency range:**  
45 at 65 Hz

**Resistance per phase:**  
3.9 k $\Omega$   $\pm$  5 %

**Make/break period:**  
Slow position: 0.5 s  
Fast position: 2.3 s

**Battery:**  
12 V DC, 8  $\times$  1.5 V "AA" batteries

**Consumption:**  
180 mA

**Battery life:**  
40 hours

### Mechanical specifications

**Reference temperature:**  
23  $^{\circ}$ C  $\pm$  3  $^{\circ}$ C

**Operating temperature:**  
0  $^{\circ}$ C to +50  $^{\circ}$ C, between 10 % and 90 % RH

**Storage temperature:**  
-40  $^{\circ}$ C to +70  $^{\circ}$ C, between 10 % and 90 % RH

**Self-extinguishing capability:**  
UL94 V0

**Colour:**  
yellow

**Dimensions:**  
220 x 136 x 150 mm

**Weight:**  
1.3 Kg

### Safety specifications

**Dielectric test:**  
6 kV between the lead and the unit

**Operating voltage:**  
600 V rms

To order	Reference
AN1 artificial neutral box with shoulder bag, batteries, set of leads, croc-clips and user's manual	P01197201
Accessories: spare shoulder bag n. 2	P01298005

Date : \_\_\_\_ / \_\_\_\_ / \_\_\_\_

ADDRESS DETAILS	
Surname: _____	Profession: _____
First name: _____	Sector of industry: _____
Company: _____	_____
Address: _____	_____
_____	_____
Town: _____	_____
Post code: _____	Tel: _____
Country: _____	Fax: _____

APPLICATION DETAILS
Description/comments: _____
_____
_____

DESIRED SPECIFICATION	
■ Type of measurement:	<input type="checkbox"/> AC <input type="checkbox"/> DC <input type="checkbox"/> AC + DC
■ Measurement range:	from _____ A to _____ A
■ Accuracy:	_____ % of output signal
■ Bandwidth:	from _____ Hz to _____ Hz
■ Output signal:	<input type="checkbox"/> AAC <input type="checkbox"/> V AC <input type="checkbox"/> V DC
■ Number of calibres: _____	1 calibre: _____ A      Sensitivity: _____ /A 2 calibre: _____ A      Sensitivity: _____ /A 3 calibre: _____ A      Sensitivity: _____ /A
■ Operating open circuit (or working) voltage of the installation where the measurements are to be carried out:	
<input type="checkbox"/> 230 V <input type="checkbox"/> 400 V <input type="checkbox"/> 600 V <input type="checkbox"/> 1000 V <input type="checkbox"/> Other: _____ V	
■ Diameter of measured conductor: _____ mm or dimensions: _____ x _____ mm	
■ Temperature of conductor in use: from _____ ° to _____ ° <input type="checkbox"/> °C <input type="checkbox"/> °F	
■ Output connector:	■ Colour:
<input type="checkbox"/> Safety sockets Ø 4 mm	Jaws: <input type="checkbox"/> Red CHAUVIN ARNOUX (standard)
<input type="checkbox"/> Length of lead 1.5 m + safety plug Ø 4 mm	<input type="checkbox"/> Other: _____
<input type="checkbox"/> 2 m coaxial lead with isolated BNC	Casing: <input type="checkbox"/> Grey CHAUVIN ARNOUX (standard)
<input type="checkbox"/> Other: _____	<input type="checkbox"/> Other: _____

DELIVERY FORMAT	
<input type="checkbox"/> Without instruction manual <input type="checkbox"/> With CHAUVIN ARNOUX instruction manual (standard) <input type="checkbox"/> With customized operating instructions <input type="checkbox"/> CHAUVIN ARNOUX product marking (standard) <input type="checkbox"/> Customized brand markings (supply all plans, diagrams, logo, etc. necessary for personalisation)	<b>■ Packaging</b> <input type="checkbox"/> Standard CHAUVIN ARNOUX cardboard box <input type="checkbox"/> Plain cardboard box <input type="checkbox"/> Other: _____ _____ _____

YOUR ORDER	
First delivery quantity: _____	Desired delivery time: _____
Quantity per year: _____	Frequency of deliveries: _____

FAX THIS PAGE TO: +33 1 46 27 73 89

# Chauvin Arnoux

A LOCAL SERVICE  
FOR A BETTER SERVICE

## A centralized contact

**Chauvin Arnoux**  
190, rue Championnet  
75876 PARIS Cedex 18  
[www.chauvin-arnoux.fr](http://www.chauvin-arnoux.fr)

### France

Tel.: 01 44 85 44 85  
Fax: 01 46 27 73 89  
[info@chauvin-arnoux.fr](mailto:info@chauvin-arnoux.fr)

### International

Tel.: +33 1 44 85 44 85  
Fax: +33 1 46 27 95 59  
[export@chauvin-arnoux.fr](mailto:export@chauvin-arnoux.fr)

## Contacts in your country

### MIDDLE EAST

**Chauvin Arnoux Middle East**  
PO Box 60-154  
1241 2020 JAL EL DIB (Beirut)  
LEBANON  
Tel.: (01) 89 04 25  
Fax: (01) 89 04 24  
[camie@chauvin-arnoux.com](mailto:camie@chauvin-arnoux.com)  
[www.chauvin-arnoux.com](http://www.chauvin-arnoux.com)

### UNITED KINGDOM

**Chauvin Arnoux Ltd**  
Unit 1 Nelson Ct, Flagship Sq,  
Shaw Cross Business Pk  
Dewsbury, West Yorkshire - WF12 7TH  
Tel.: 01924 460 494  
Fax: 01924 455 328  
[info@chauvin-arnoux.co.uk](mailto:info@chauvin-arnoux.co.uk)  
[www.chauvin-arnoux.com](http://www.chauvin-arnoux.com)

### USA

**Chauvin Arnoux Inc**  
d.b.a AEMC Instruments  
200 Foxborough Blvd.  
Foxborough - MA 02035  
Tel.: (508) 698-2115  
Fax: (508) 698-2118  
[sales@aemc.com](mailto:sales@aemc.com)  
[www.aemc.com](http://www.aemc.com)

# Chauvin Arnoux

10 SUBSIDIARIES

## WORLDWIDE

### AUSTRIA

**Chauvin Arnoux Ges.m.b.H**  
Tel.: +43 1 61 61 9 61  
Fax: +43 1 61 61 9 61-61  
[vie-office@chauvin-arnoux.at](mailto:vie-office@chauvin-arnoux.at)  
[www.chauvin-arnoux.at](http://www.chauvin-arnoux.at)

### CHINA

**Shanghai Pu-Jiang  
Enerdis Instruments Co. Ltd**  
Tel.: +86 21 65 21 51 96  
Fax: +86 21 65 21 61 07  
[info@chauvin-arnoux.com.cn](mailto:info@chauvin-arnoux.com.cn)

### GERMANY

**Chauvin Arnoux GmbH**  
Tel.: +49 07851 99 26-0  
Fax: +49 07851 99 26-60  
[info@chauvin-arnoux.de](mailto:info@chauvin-arnoux.de)  
[www.chauvin-arnoux.de](http://www.chauvin-arnoux.de)

### ITALY

**AMRA SpA**  
Tel.: +39 039 245 75 45  
Fax: +39 039 481 561  
[info@amra-chauvin-arnoux.it](mailto:info@amra-chauvin-arnoux.it)  
[www.chauvin-arnoux.it](http://www.chauvin-arnoux.it)

### MIDDLE EAST

**Chauvin Arnoux Middle East**  
Tel.: +961 1 890 425  
Fax: +961 1 890 424  
[camie@chauvin-arnoux.com](mailto:camie@chauvin-arnoux.com)  
[www.chauvin-arnoux.com](http://www.chauvin-arnoux.com)

### SPAIN

**Chauvin Arnoux Ibérica SA**  
Tel.: +34 902 20 22 26  
Fax: +34 93 459 14 43  
[comercial@chauvin-arnoux.es](mailto:comercial@chauvin-arnoux.es)  
[www.chauvin-arnoux.es](http://www.chauvin-arnoux.es)

### SCANDINAVIA

**CA Mätssystem AB**  
Tel.: +46 8 50 52 68 00  
Fax: +46 8 50 52 68 10  
[info@camatsystem.com](mailto:info@camatsystem.com)  
[www.camatsystem.com](http://www.camatsystem.com)

### SWITZERLAND

**Chauvin Arnoux AG**  
Tel.: +41 44 727 75 55  
Fax: +41 44 727 75 56  
[info@chauvin-arnoux.ch](mailto:info@chauvin-arnoux.ch)  
[www.chauvin-arnoux.ch](http://www.chauvin-arnoux.ch)

### UNITED KINGDOM

**Chauvin Arnoux Ltd**  
Tel.: +44 1924 460 494  
Fax: +44 1924 455 328  
[info@chauvin-arnoux.co.uk](mailto:info@chauvin-arnoux.co.uk)  
[www.chauvin-arnoux.com](http://www.chauvin-arnoux.com)

### USA

**Chauvin Arnoux Inc**  
d.b.a AEMC Instruments  
Tel.: +1 (508) 698-2115  
Fax: +1 (508) 698-2118  
[sales@aemc.com](mailto:sales@aemc.com)  
[www.aemc.com](http://www.aemc.com)

